

# COLOR GUARD®

RAILING SYSTEMS



★★ MADE IN THE USA ★★



# THE PATRIOT

Mounts to wood, concrete or composite surfaces.  
Adjusts to an 11° angle. Adjusts to fit 36" and 42" high railing.

### Sizes

4" x 4" x 37"

5" x 5" x 37"

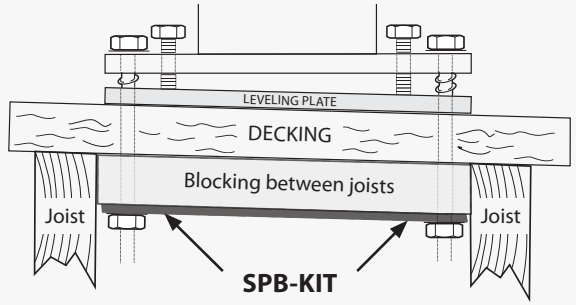

### SPB-KIT

The SPB-KIT is used beneath deck boards with properly installed blocking.



### SPB-66KIT

The SPB-66KIT nests around the fillers of the SPB-44BPL to fill out 6" x 6" post sleeves.



## A Better Solution than Wood Posts



Properly anchor post mount.



Adjust leveling bolts. Allows 11° variance in any direction.



Attach fillers and place sleeve over post.





# PREMIUM VINYL RAILING

For over 20 years, Color Guard has been producing a top-quality vinyl railing, whose safety and ease of installation is unmatched in the industry.

## • EVERYTHING YOU NEED IS IN THE BOX

Our railing comes “fully-kitted” and includes top and bottom railing, aluminum reinforcement, balusters, brackets, support block and stainless steel hardware

## • A TOTAL RAILING SOLUTION

With our broad line of accessories, we have a solution to fit every project need, from load-bearing porch posts, post wraps, angle adapters, and gate kits, to designer or solar cap options

Stair section bracket designed for any angle from 23° to 38°—no mitering of the rails or cuts to the bracket or balusters

## • EASY INSTALLATION

Faster and easier to install than our competition

Railing sections are true-to-length: 6' = 72" of railing to fit a 6' opening

## • SAFETY FIRST

Our products are submitted to a third-party for testing and exceed today's code requirements

A sturdy, high-gauge aluminum reinforcement is in every top and bottom rail we produce and set screws on each side of the rail bracket attach the rail section to the aluminum reinforcement



5' or longer straight railing sections contain a spring-loaded locking baluster to keep rails from separating if subjected to excess load on the top or bottom rails

## • LIMITED LIFETIME WARRANTY

• **MADE IN THE USA** Proudly produced in Wisconsin with virgin PVC





PREMIUM VINYL WITH DRINK RAIL OPTIONS

# FLORENCE

Complete your installation with Verona or Tuscany stair and gate kits.  
Fully-kitted with black 3/4" round aluminum balusters.

	Height	Length
Straight	36"	6', 8', 10'
Straight	42"	6', 8', 10'

**Colors**

		
White	Tan	Clay





PREMIUM VINYL WITH DRINK RAIL OPTIONS

# KEY WEST

Complete your deck with a Classic or Savannah stair rail kit.

Pairs with a Savannah gate.

	Height	Length
Straight	36"	6', 8', 10'
Straight	42"	6', 8', 10'

## Colors

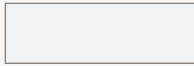

White



Tan



Clay



**FLORENCE** and **KEY WEST** both use a deck board on the top rail for a highly coordinated look with your decking. Fully customizable with your choice of drink rail topper (*sourced separately*).



# VERONA

Fully-kitted with black 3/4" round aluminum balusters.

	Height	Length
Straight	36"	4', 6', 8', 10'
Stair	36"	6', 8'
Straight	42"	6', 8'
Stair	42"	6', 8'

**Colors**



White



Tan



Clay







PREMIUM VINYL RAILING

# TUSCANY

Fully-kitted with black 3/4" round aluminum balusters. *Optional baluster baskets shown at left. Stair rail available in 36" height only.*

	Height	Length
Straight	36"	4', 6', 8', 10'
Stair	36"	6', 8'
Straight	42"	6', 8'

**Colors**



White



Tan



Clay









PREMIUM VINYL RAILING

# CLASSIC

Our most popular Premium Vinyl Railing.

	Height	Length
Straight	36"	4', 5', 6', 7', 8', 10'
Stair	36"	4', 6', 8', 10'
Straight	42"	4', 5', 6', 7', 8', 10'
Stair	42"	6', 8'

Colors



White



Tan



Clay





# SAVANNAH

Stair rail brackets accommodate angles 23°–38°

Stair rail available in 36" height only.

	Height	Length
Straight	36"	4', 6', 8', 10'
Stair	36"	4', 6', 8',
Straight	42"	4', 6', 8', 10'

**Colors**

		
White	Tan	Clay









PREMIUM VINYL RAILING

# ARCHITECTURAL

Stair rail brackets accommodate angles 23°–38°. *Stair rail available in 36" height only.*

	Height	Length
Straight	36"	4', 6', 8', 10'
Stair	36"	4', 6', 8'
Straight	42"	4', 6', 8', 10'

## Colors



White



Tan



Clay





# NEWEL POST

Pairs well with Architectural Railing and Colonnade Porch Posts.

## Sizes

4" x 4" x 38"

4" x 4" x 44"

## Colors



White



Tan



Clay



Newel features its own leveling hardware for quick and easy installation.







# POST SLEEVE

Post sleeves provide an efficient way to cover treated wood posts.

**Sizes**

2" x 4" x 120"	4" x 4" x 38"	5" x 5" x 108"	6" x 6" x 38"*
	4" x 4" x 44"		6" x 6" x 44"
	4" x 4" x 50"		6" x 6" x 120"
	4" x 4" x 96"		
	4" x 4" x 108"		
	4" x 4" x 120"		

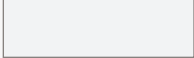
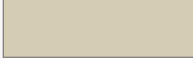
**Colors**

		
White	Tan	Clay

\*6" x 6" x 38" available in white only



# VINYL ACCESSORIES



**Straight Rail Bracket**



**Stair Rail Bracket**

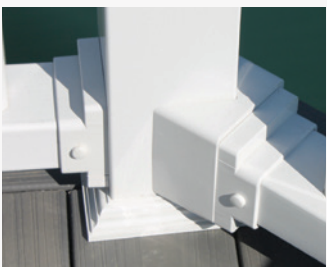

**45° Rail Bracket**



**Stair Rail Bracket with Column Adapter**



**Column Adapter**  
Accommodates 10"-12" columns  
Straight & Stair



**22 1/2° Rail Adapter**  
Straight & Stair



**45° Rail Adapter**  
Straight & Stair



# DESIGNER & SOLAR CAPS

Matching collars available. Long-lasting powder coated metallic finishes.



**NEPTUNE**  
For 3" x 3"  
Aluminum Posts

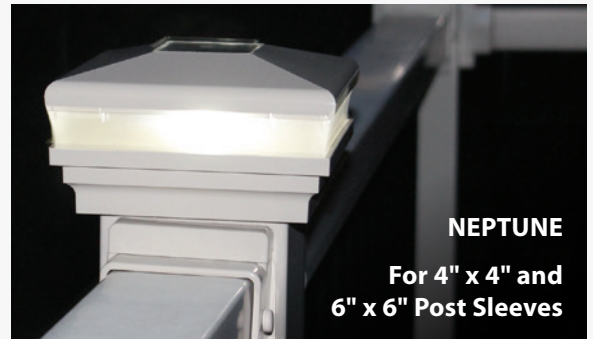

**NEPTUNE**  
For 4" x 4" and  
6" x 6" Post Sleeves



**APOLLO**  
For 4" x 4" and 6" x 6" Post Sleeves and  
3" x 3" Aluminum Posts

Antique Gray  
4" x 4"

Antique Gold  
4" x 4"

Hammertone Black  
4" x 4", 6" x 6"



Antique Copper  
4" x 4"

Antique Brown  
4" x 4"

Patina  
4" x 4"

**Colors**



White



Tan



Clay



4" x 4"  
5" x 5"  
6" x 6"

**Flat**



4" x 4"  
5" x 5"  
6" x 6"

**New England**



4" x 4"

**Gothic (White only)**



4" x 4"

**Dome (White only)**



STRUCTURAL POST

# COLONNADE

Porch posts provide the industry's easiest installation.

Rated at 5,400 lbs. load-bearing capacity.

## Size

5" x 5" x 108"

## Colors



Polar White



White



Tan



Clay





STRUCTURAL POST

# SMOOTH

The Smooth Structural Post provides a simpler look.

Rated at 5,400 lbs. load-bearing capacity.

**Size**

5" x 5" x 108"

**Colors**



Polar White

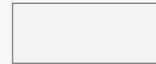

White

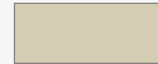

Tan



Clay

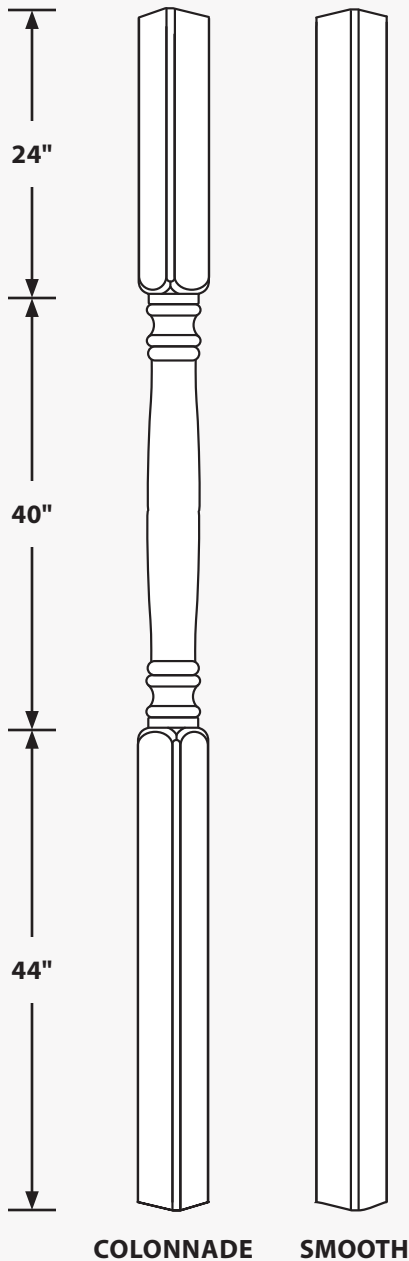

**COLONNADE SMOOTH**



Our structural posts feature an easy installation that makes this a great product for both new construction and retrofits.

**Inside View**



**Tie-Down Plate**





# POST WRAP

Our easy-to-install Post Wraps can be installed on existing wood posts and provide protection and low-maintenance. Available in four-piece kits in a smooth or fluted profile.

**FLUTED**

Sizes	Polar White	White	Tan	Clay
4" x 4"	8.5', 10'	8.5', 10'	10'	10'
6" x 6"	8.5', 10'	8.5', 10'	10'	10'
8" x 8"	10'	8.5', 10'		

**SMOOTH**

Sizes	Polar White	White	Tan	Clay
4" x 4"	8.5', 10'	8.5', 10'	10'	10'
6" x 6"	8.5', 10'	8.5', 10'	10'	10'

*\*For 4" x 6" applications, combine pieces from 4" x 4" and 6" x 6" kits*

**Colors**

			
Polar White	White	Tan	Clay





# VINYL GATES

Our adjustable gate kits fit a 48" rough-opening, but may be cut down to accommodate smaller openings. Fully-kitted with top and bottom rails, balusters, cross brace, stainless steel latch and self-closing hinges.

**Gate must be hung between solid posts!** (wood filled, or Patriot steel post mounts or structural porch posts). Available in Classic, Savannah, Verona, Tuscany and Architectural profiles.

## Heights

36"

42"

## Colors



White



Tan



Clay



CLASSIC



SAVANNAH



VERONA



# SECONDARY HANDRAIL

Compliments Color Guard Premium Vinyl Railing Systems, Color Guard Aluminum Railing Systems (requires 3 x 3 post or larger), wood railing and competitive railings. Powder-coated aluminum in 1.5" diameter to meet ADA requirements.

### Lengths

8'8", 10'

### Colors



White



Black



Bronze



Wall Bracket



In-Line Bracket



Return Bracket



90° Outside Elbow



Corner Bracket



90° Elbow



5°, 32°, 36°, 40° Elbows



P-Loop Return



End Cap



8" Straight Connector





## RELATED COMPONENTS



**P-Loop**



**In-Line Bracket**



**90° Outside Elbow**



**Return Bracket**





# ALUMINUM RAILING

Several years ago, when we expanded into Aluminum Railing, we wanted to create railing systems that met the expectations of the Color Guard Brand. We were successful in that endeavor.

• **EVERYTHING YOU NEED IS IN THE BOX** Our railing comes “fully-kitted” and includes top and bottom railing, vinyl inserts, balusters, brackets, support block and stainless steel hardware

• **EASY INSTALLATION** Most contractors say it's the easiest to install

Railing sections are true-to-length: 6' = 72" of railing to fit a 6' opening

Stair section bracket designed for any angle from 23° to 38°—no mitering of the rails or cuts to the bracket or balusters

• **A TOTAL RAILING SOLUTION** With our broad line of accessories, we have a solution to fit every project need, from structural porch posts, sleeves to cover existing 4 x 4 or 6 x 6 wood posts, Patriot structural posts, gate kits, solar lighting, drink rail brackets and over-the-post elements

Posts and Post Sleeves are offered in multiple sizes

Styles available in round and square balusters

Non-stamped options for completely custom creations

• **CURB APPEAL AND QUALITY FEEL**

All of our aluminum railing products are powder-coated with a hammered, textured finish

15-Year Finish Warranty in most environments

Solid to the touch, with no audible rattle

A vinyl insert in every top and bottom rail eliminates metal-on-metal contact

• **MADE IN THE USA** Proudly manufactured and powder-coated in Wisconsin



ALUMINUM RAILING



# GRAND PRIX

Features 3/4" round balusters. *Stair rail available in 36" height only.*

	Height	Length
Straight	36"	6', 8', 10'
Stair	36"	6', 8'
Straight	42"	6', 8', 10'

Colors



Black

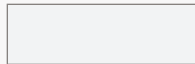

White



Bronze





# LINCOLN

Features 3/4" square balusters.

	Height	Length		Height	Length
Straight	36"	4', 5', 6', 7', 8', 10'	Straight	36"	4', 6', 8', 10'
Adjustable Stair	36"	4', 5', 6', 7', 8'	Adjustable Stair	36"	6', 8'
Fixed Stair	36"	6', 8'	Fixed Stair	36"	6', 8'
Straight	42"	4', 5', 6', 7', 8', 10'	Straight	42"	4', 6', 8', 10'
Adjustable Stair	42"	6', 8'			

**Colors**



White



Black



Bronze

**Color**



Black & White





# ALUMINUM ACCESSORIES

Colors



White



Black



Bronze



**Blank Post Sleeves**  
Conceals existing wood posts.  
Sizes: 4" x 4", 6" x 6"

**Post with cap & collar**  
Sizes: 2" x 2" (Black only),  
3" x 3"

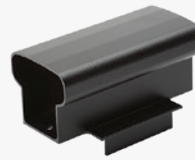

**Straight**

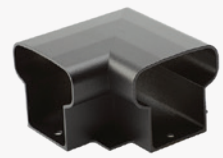

**Corner**



**End**



**Stair**

**Over-The-Post Bracket**  
Allows for a continuous rail design.



**3" x 3" Post Feature**  
Available in 37", 43", and 49" heights.  
Includes stainless steel leveling strips.



6" x 6" Post Sleeves with Lincoln Railing in  
screen porch application.



ALUMINUM RAILING

# SENTINEL PORCH POST

Structural aluminum posts with simple installation.

## Size

4" x 4" x 108" (12,000 lbs. load rating, post collars included)

6" x 6" x 108" (30,000 lbs. load rating)

## Colors



White



Black



Bronze







ALUMINUM RAILING

# NON-STAMPED RAIL

Add visual appeal to your cable rail application with our portfolio of complimentary products. Works with most third-party cable rail systems (sourced separately). \*Top and bottom rails sold as individual kits.

	Length
Straight*	6', 8', 10'
Stair*	6', 8'

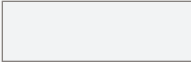
Colors			
			
	White	Black	Bronze





# ASPEN

Provides a minimalistic, symmetrical look and features 3/4" round balusters.

	Height	Length
Straight	36"	6', 8', 10'
Stair	36"	6', 8'

**Color**



Black





# ALUMINUM GATE

Our adjustable 4' gate fits 50" rough opening. Fully-kitted with stainless steel latch and self-closing hinges.

## Heights

36"

42"

## Colors



Black

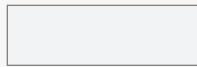

White



Bronze

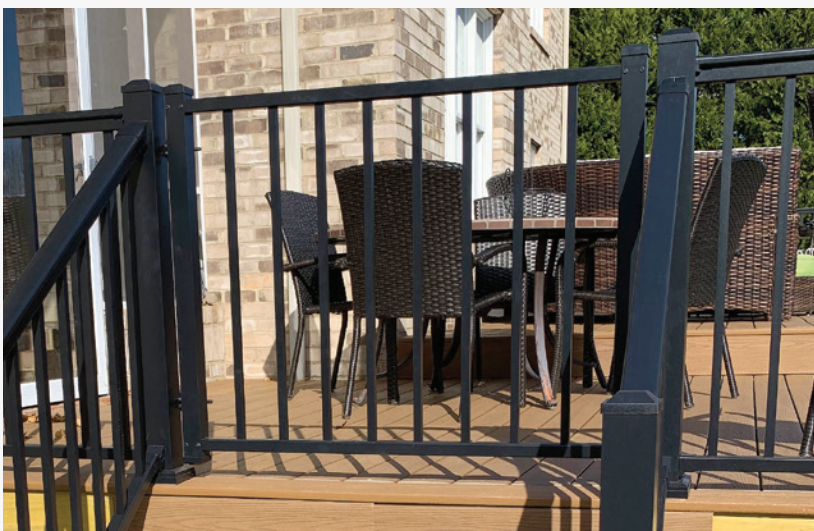

## ALUMINUM ACCESSORIES

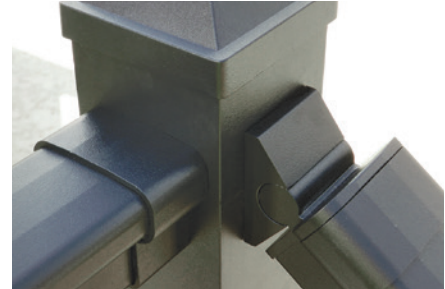

**Adjustable Stair**  
(angles up to 38°)



**Fixed Stair**  
(32-36°)



**Variable Angle Wedge**  
(enables horizontal angles up to 50°)



**Drink Rail Bracket System**



# UPSIDE DECK CEILING

## Channel Sizes

10', 12', 16'

## Colors



White



Tan



Can adapt for ceiling fans and light fixtures



Compatible with most gutter systems

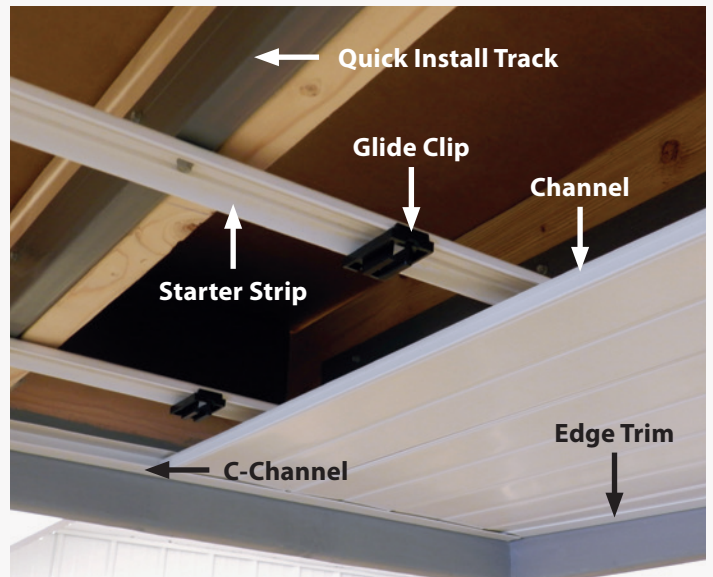





**UPSIDE COMPONENTS**



ECOGuard steel screws with 1000-hour salt-spray protective coating

**Quick Install Track**



**Starter Strip**



**Glide Clip**



**Colors**

White

Tan

**C-Channel**



**Colors**

White

Tan

**Edge Trim**



**Colors**

White

Tan

**Channel**



# UpSide™ DECK CEILING

See page 30 for more details.



Establish a dry, attractive outdoor living area beneath your deck with our water-channeling system that also creates a finished ceiling with a bead-board appearance.





**Color Guard® Inc.**  
PO Box 28  
Sheboygan Falls, WI 53085

Phone: 800-832-8914  
Fax: 800-638-4695

 Made in USA

Learn more at

[ColorGuardRailing.com](http://ColorGuardRailing.com)  
[UpSideByColorGuard.com](http://UpSideByColorGuard.com)

 @colorguardrailing  
 ColorGuardRailing

LIT-2022