

NAPOLEON



ELECTRIC MANTELS / ENTERTAINMENT UNITS,
BUILT-IN FIREPLACES AND LOG SETS

napoleonfireplaces.com



Interior space has never been more flexible.

Ascent [™] Electric 33 & 40 - NEFB33H / NEFB40H.....	4 - 5
Cinema [™] Log Series - NEFB24/27/29H-3A.....	6 - 7
Cinema [™] Glass Series - NEFB24/27/29HG-3A.....	8 - 9
Tranquille [™] 30 NEFB30GL.....	10 - 11
Woodland [™] Log Set - NEFI18/24/27H.....	12 - 13
Outstanding Features.....	14 - 15
<i>Decor Series Mantels and Entertainment Packages</i>	16
The Colbert Entertainment Package.....	17
The Aden Mantel Package.....	18
The Taylor Mantel Package.....	19
The Monroe Mantel Package.....	20
The Harlow Mantel Package.....	21
<i>Essential Series Mantels and Entertainment Packages</i>	22
Canterbury Entertainment Package.....	24
Adele Entertainment Package.....	25
Anya Entertainment Package.....	26
Foley Entertainment Package.....	27
Crawford Mantel Package.....	28
Whitney Mantel Package.....	29
Braxton Mantel Package.....	30
Bailey Mantel Package.....	31
<i>Prestige Series Entertainment Packages</i>	32
The Shelton Entertainment Package.....	34
The Alanis Entertainment Package.....	35



Essentials Series Adele Entertainment Package shown



FIND YOUR HAPPY (fire)PLACE.

Throughout the ages, people have gathered around fires to share in life's greatest joys.

There's just something about the glow of flickering flames that makes special moments feel even warmer.

A Napoleon fireplace is uniquely designed to brighten the vibe of any room in your house. Napoleon has an incredible range of designer options to fit any vision.

A fire not only raises the warmth and ambiance of a room, it can raise the value of your home. A fireplace offers some of the highest returns of any remodeling project. And that should make you feel good all over.

And so you can keep enjoying that positive glow for years and years and years, every Napoleon fireplace is backed by an exclusive warranty program.



We are proud to be recognized as one of Canada's Best Managed Companies and are dedicated to providing quality, home comfort products for over 40 years and counting.

Ascent™ Electric 33 & 40

Built-In Electric Fireplace

The Napoleon Ascent™ Electric 33 & 40 fireplaces imitate the look of a traditional masonry fireplace but with all the convenience of simply plugging it in, sitting back and enjoying the heat and glowing log set! Napoleon's flame technology randomly adjusts the flame effect, color, height and speed creating the illusion of a true wood burning fire with a modulating ember bed for a realistic glow. Perfect for any room in a house, condo, apartment or office.

5,000 BTU's (120V) | 9,000 BTU's (240V)
1,500 Watts (120V) | 2,650 Watts (240V)

For more detailed specifications visit our website: www.napoleonfireplaces.com

LOW ENERGY
LED
HIGH INTENSITY

Features & Accessories



Remote Control



Side Brick Panel Detail



Self Trimming Flange



Non-Reflective Backing



Ascent™ Electric 33
NEFB33H

28¾"h x 34"w x 9¾"d



Ascent™ Electric 40
NEFB40H

32"h x 40¾"w x 14"d



Ascent™ Electric 33 shown with NIGHT LIGHT™ set on orange



Ascent™ Electric 40 shown with NIGHT LIGHT™ set on purple



NIGHT LIGHT™
Blue, Clear, Orange and Purple



MANTEL / ENTERTAINMENT PACKAGES AVAILABLE
See the Decor Series pages 16-21



Cinema™ Log Series

Built-In Electric Fireplace

Imagine completely transforming your living space just by plugging in a fireplace. With the Napoleon Cinema™ Log series electric fireplaces you can do just that. The realistic log bed glows just like real burning logs, and when turned off, fades just like a real dying fire. Set the mood instantly with complete control over flame and ember lights, heat intensity and even set the NIGHT LIGHT™ for added ambiance. These electric fireplaces add class to your décor, no matter where you put it.

5,000 BTU's
1,500 Watts

For more detailed specifications visit our website: www.napoleonfireplaces.com

LOW ENERGY
LED
HIGH INTENSITY

Features & Accessories



Remote Control

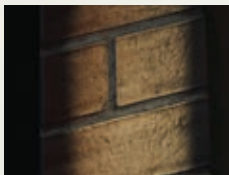

Brick Side Panel Detail
(Cinema™ Log 29 only)



Realistic Logs and
Ember Bed



Self Trimming Flange



Optional three or four
piece trim kit available



Cinema™ Log 24
NEFB24H-3A
17½"h x 24"w x 8¾"d



Cinema™ Log 27
NEFB27H-3A
18½"h x 27"w x 9½"d



Cinema™ Log 29
NEFB29H-3A
20½"h x 29"w x 9½"d



The Cinema™ 27 shown



Cinema™ 29 shown with NIGHT LIGHT™ set circulating multi-color



NIGHT LIGHT™
Blue, Clear, Orange and Multi-Color Circulating Mode
(NEFB27H-3A & NEFB29H-3A only)

NIGHT LIGHT™
Can be used
independently



MANTEL / ENTERTAINMENT PACKAGES AVAILABLE
See the Essentials Series pages 22-31



Cinema™ Glass Series

Built-In Electric Fireplace

The glow from a Napoleon Cinema™ Glass Built-In Electric Fireplace will transform any room by adding a sparkling and luxurious touch. No venting or chimneys are needed to fill your space with the warmth and glow of a Napoleon Fireplace. The topaz glass ember bed scintillates, setting the perfect mood, lit by the flickering flames, or the unique, multicolored NIGHT LIGHT™. Perfect your space with three size options.

5,000 BTU's
1,500 Watts

For more detailed specifications visit our website: www.napoleonfireplaces.com

LOW ENERGY
LED
HIGH INTENSITY

Features & Accessories



Remote Control



Topaz Glass Ember Bed



Self Trimming Flange



Optional three or four piece trim kit available



Cinema™ Glass 24
NEFB24HG-3A
17½"h x 24"w x 8¾"d



Cinema™ Glass 27
NEFB27HG-3A
18½"h x 27"w x 9¾"d



Cinema™ Glass 29
NEFB29HG-3A
20½"h x 29"w x 9¾"d





The Cinema™ Glass 24 shown with four piece trim



The Cinema™ Glass 29 shown



NIGHT LIGHT™
Blue, Clear, Orange and Multi-Color Circulating Mode

NIGHT LIGHT™
Can be used independently



MANTEL / ENTERTAINMENT PACKAGES AVAILABLE
See the Essentials Series pages 22-31



Tranquille™ 30

Built-In Electric Fireplace

Napoleon's Tranquille™ 30 Electric Fireplace comes complete with both a log set and CRYSTALINE™ glass ember bed ensuring a seamless match to your style and tastes, plus you can change it up anytime the mood strikes. The convenient on/off switch on the unit or the remote, allows you to relax, while remaining in total control of the flame and ember bed brightness. The Tranquille™ 30 reflective rear panel mirrors the flames giving you fireplace depth without actually taking up space.

NEFB30GL

5,000 BTU's

1,500 Watts

32¼"h x 30"w x 10¼"d

For more detailed specifications visit our website: www.napoleonfireplaces.com

LOW ENERGY
LED
HIGH INTENSITY



Tranquille™ 30 shown with CRYSTALINE™ Ember Bed and flames set on combined orange and blue

Features & Accessories



Remote Control



CRYSTALINE™ Ember Bed



Traditional Log Set



Tranquille™ 30 shown with log set and flames set on orange



Flames and NIGHT LIGHT™
Blue, Pink, Orange and Multi-Color



Woodland™ Series

Electric Log Sets

The Woodland™ Series are used in an insert style installation, just plug in and place in a pre-existing masonry fireplace. Backed by over 40 years of experience working with real flames, Napoleon is applying that knowledge to their rapidly growing electric fireplace line. These beautifully designed electric log sets offer authentic glowing logs and realistic flames. The Woodland™ series comes in three sizes and allows you to enjoy the look and ambiance of a gas or wood fireplace without any mess, fuss or costly installation fees.

5,000 BTU's
1,500 Watts

For more detailed specifications visit our website: www.napoleonfireplaces.com

LOW ENERGY
LED
HIGH INTENSITY

Features & Accessories



Remote Control



Natural Slow Dying Ember Bed
(NEFI24H & NEFI27H only)



Hand Painted Resin Log Set



Realistic Burning Logs



Customizable Glow



Woodland™ 18
NEFI18H
13½" h x 18" w x 13" d



Woodland™ 24
NEFI24H
14¼" h x 24" w x 14¼" d



Woodland™ 27
NEFI27H
15½" h x 26¾" w x 14¼" d





Woodland™ 18 shown



Woodland™ 24 shown



Outstanding Features

of Napoleon's Advanced Technology



Reliable LED Technology

Napoleon's electric fireplaces offer reliable LED technology for added convenience. LED lights are extremely energy efficient and long-lasting saving you the hassle of having to change out light bulbs. Plus LED lights are high intensity providing a product you can enjoy during both day and night time.



Self Trimming

A self trimming flange on all of Napoleon's electric built-in fireplaces guarantees an easy installation and removes the difficulty of needing a perfect cut on your surrounding material. The self trimming flange provides a perfect clean finish every time.

Small Details - Big Impact

Napoleon's non-reflective backing allows the fireplace flames to stand out while minimizing distracting reflections from the surrounding room. With flames, logs and ember beds this realistic, you're sure to fully enjoy them.



ELECTRIC FIREPLACE

Economical to Operate



ULTRA BRIGHT LED LIGHTS

Provide day or night intensity



ADJUSTABLE TEMPERATURE

Adjust the heat being produced by choosing a temperature



PLUG IN

Simply plug in and your fireplace is ready



HARD WIRED

Can be hard wired into existing home wiring (not applicable with the Woodland™ electric log set series)



SAFE TO TOUCH

Never hot enough to burn



WHISPER QUIET™

Operates at a whisper to ensure enjoyment



ECO-FRIENDLY

Only heat the rooms you use most



NON-REFLECTIVE BACKING

Allows for optimal flame viewing (not applicable with the Woodland™ electric log set series)



FULL FEATURE REMOTE

Controls thermostat, heat settings, flame settings, timer, on/off and more



SAVE UP TO 30%
WITH NAPOLEON'S
ZONE
Heating



CAN BE RECESSED

The Ascent™ series can be fully recessed



BRILLIANT CRYSTALS

Exclusive Topaz glass ember bed slowly dies out when turned off for an authentic fireplace experience (Cinema™ Glass Series)



REALISTIC LOG SET

Realistic logset and ember bed slowly die out when turned off for an authentic fireplace experience (Cinema™ Series)

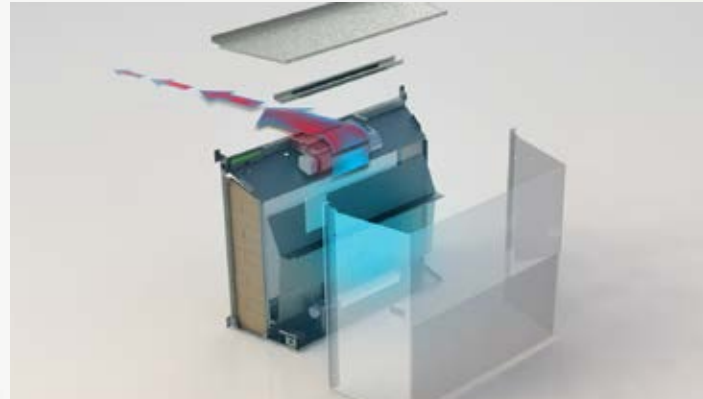

Front Heat

Napoleon's built-in electric fireplaces are designed to blow heat out the front of the unit allowing a more efficient and direct route to zone heating your room.

Mantel Packages

Napoleon's Ascent™ series, Cinema™ Log and Cinema™ Glass series offer a variety of mantel packages to choose from, perfect for those wanting an aesthetically pleasing focal point in their room.

Transformation

All Napoleon's built-in products, including the Ascent™ series, Cinema™ Log series, Cinema™ Glass series and Woodland™ log sets series, allow an affordable and quick transformation of an old masonry opening into a beautiful new fireplace and eliminates the chore of cleaning dirt and ashes of a traditional wood fireplace.

DESIGNED TO TAKE THE STRESS OUT OF EVERYDAY LIFE.

DECOR MANTEL AND ENTERTAINMENT PACKAGES COLLECTION

Napoleon Decor Mantel and Entertainment Packages combine centuries-old tradition and elegance with modern flair and functionality for a truly exceptional statement piece. With four mantel style options to choose from available with the Ascent™ Electric 33 firebox and the Aden mantel available with the Ascent™ Electric 40 firebox, you are sure to find the masterpiece that speaks to you. A broad array of finishes, decorative pieces, textures, inlays and pedestal bases, not only work with your home decor but enhance your rooms ambiance.

For detailed mantel specifications visit our website: www.napoleonfireplaces.com

LOW ENERGY
LED
HIGH INTENSITY

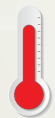

Heats up to
400 sq. ft.

4
SEASON
ENJOYMENT

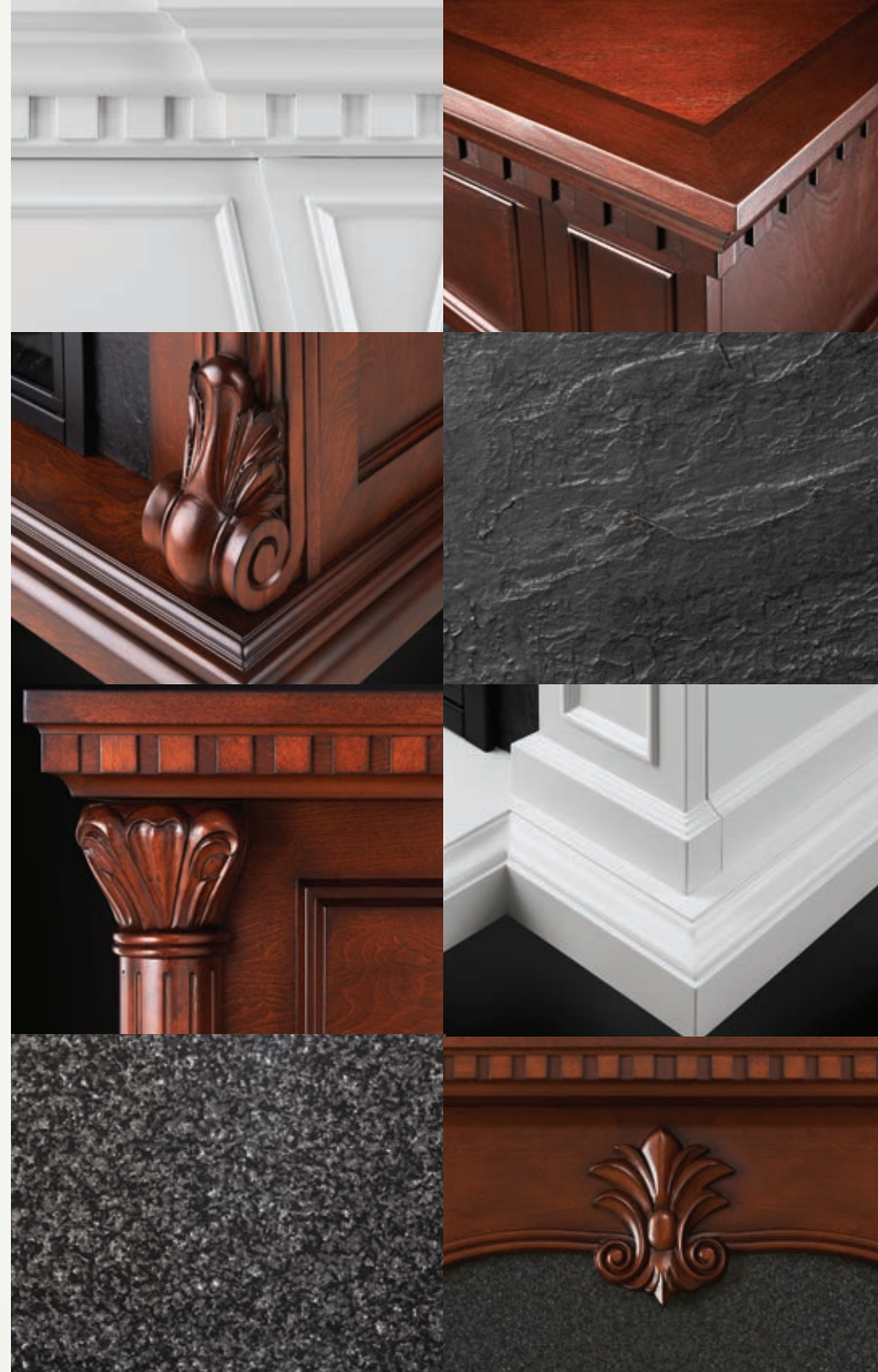

The Colbert

In a practical yet handsome combination of function and decor, the Colbert offers an abundance of features for owners looking to get more out of their mantel. Soft closing, bevelled glass doors with iron accents offer cupboard space to place your treasured possessions on display. Motion sensor LED lights light the way to soft closing drawers and doors for a quiet, pleasant and reliable experience.

65" w x 20" d x 44 1/3" h
(NEFP33-0614AM)



Comes with the Ascent® Electric 33
(See Pages 4-5 for firebox details)



Inlay with Diamond
Cut Top



Soft-close Media
Door



Self Closing Drawers
and Doors

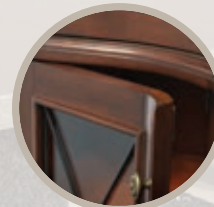

Bevelled Glass Door with
Interior LED Accent Lights

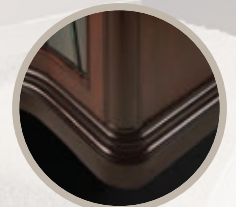

Pedestal Base

The Aden

The magnificent stature of the Aden mantel combined with the alluring cherry wood finish produces a forceful presence in any home. Solid wood hand carved columns border the sides of the mantel while encompassing a beautiful Victorian hand carved ornament. The Aden is simply GRAND and will demand the attention of all those who bask in its warm glow.

64" w x 20" d x 53 3/8" h
(NEFP40-0714C)

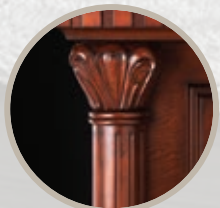

Dentil Accent Molding and Solid Hand Carved Columns

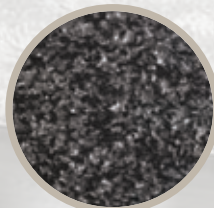

Black Granite Styled Surround



Solid wood, hand carved ornament



Pedestal Base



Cherry Wood Finish



Comes with the Ascent[®] Electric 40 (See Pages 4-5 for firebox details)

The Taylor

The Taylor mantel mimics these sentiments by encasing your fireplace with decorative features in a classic white finish. The black slate styled surround creates a striking contrast against the white finish and produces a modern and pure look for your fireplace. Dentil molding, ornamental focus point and inset panels all emerge together creating an elegant and timeless piece set upon a prominent pedestal base.

55" w x 16 3/4" d x 45 1/2" h
(NEFP33-0214W)



Comes with the Ascent® Electric 33
(See Pages 4-5 for firebox details)



Dentil Accent Molding

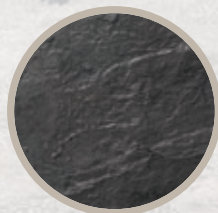

Black Slate
Styled Surround



Decorative Keystone

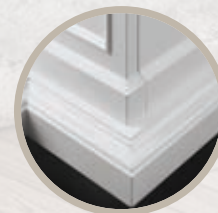

Pedestal Base



Classic White Finish

The Monroe

The Monroe mantel lives up to its name with a burnished walnut finish that will turn heads and keep the focus of those who are in its presence. Solid wood decorative rope molding and hand carved solid wood columns add a level of intricate detail while framing and capturing the allure of the fireplace itself.

57 1/2" w x 18" d x 45" h
(NEFP33-0314BW)



Rope Molding and Solid Wood Hand Carved Columns

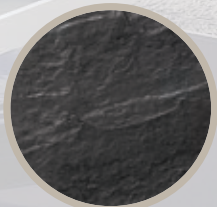

Black Slate Styled Surround



Inlay with Diamond Cut Top

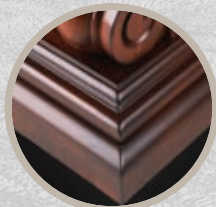

Pedestal Base

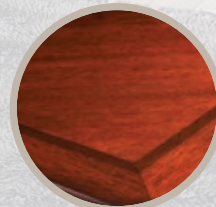

Burnished Walnut Finish



Comes with the Ascent[®] Electric 33
(See Pages 4-5 for firebox details)

The Harlow

The elegance that the Harlow mantel possesses is truly timeless. The warm feel of the mahogany finish paired with the multitude of simple yet stunning details, create an overall balanced and powerful presence. Experience sophistication with a solid wood, hand carved floral focal point surrounded by rich panel insets and topped with a decorative dentil molding.



55" w x 16 3/4" d x 45 1/2" h
(NEFP33-0114M)



Comes with the Ascent® Electric 33
(See Pages 4-5 for firebox details)



Dentil Accent Molding



Inlay with Diamond
Cut Top



Decorative Keystone

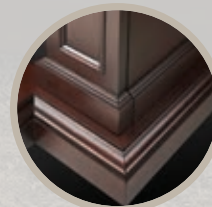

Pedestal Base

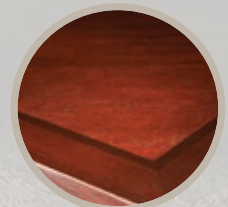

Mahogany Finish

A TIMELESS HEIRLOOM TO STAY IN THE FAMILY FOR AGES TO COME.

ESSENTIALS MANTEL AND ENTERTAINMENT PACKAGES COLLECTION

Napoleon Essentials Mantel and Entertainment packages offer a variety of finishes and sizes to ensure the perfect fit for your needs. From contemporary flare to traditional elegance there are several mantel options in this collection available with Cinema™ Log and Cinema™ Glass series fireboxes. Choose the mantel that suits your home, your tastes and your lifestyle. Enhance your room's atmosphere with a variety of inlays, pedestal bases, hidden compartments, decorative doors, hardware, solid hardwood pieces and much, much more.

For detailed mantel specifications visit our website: www.napoleonfireplaces.com



LOW ENERGY
LED
HIGH INTENSITY

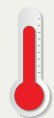

Heats up to
400 sq. ft.





The Canterbury

The Canterbury is not only a functional entertainment center but an aesthetically captivating focal point. Crafted with a luxurious inlay with a diamond cut top, the Canterbury stands out from the crowd. Decorative side columns stand on a beautiful pedestal base, enclosing the Cinema™ 29 firebox. Other details like the decorative hardware and glass doors create a classic appearance to appease any taste.

64" w x 20" d x 34" h
(NEFP29-1415E)



Decorative Side Columns

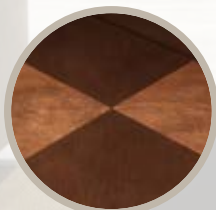

Inlay with Diamond Cut Top

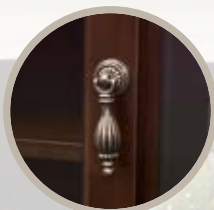

Decorative Hardware

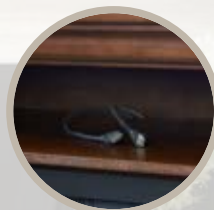

Electronic Media Compartment with Wire Management System



Can be used independently as a NIGHT LIGHT™



Comes with the Cinema™ 29 (See Pages 6-7 for firebox details)

The Adele

The Adele entertainment package is all modern flare with contemporary hardware, curved lines and finished in trendy white. Decorative glass doors and shelves allow books and other possessions to be on display or can be used for electronic components with the built-in glass shelf wire management system. The Adele is sure to stand out with the Cinema™ 27 firebox encompassed by clean, crisp white.

56" w x 16" d x 32" h
(NEFP27-0815W)



Comes with the Cinema™ 27
(See Pages 6-7 for firebox details)



Contemporary Hardware



Decorative Glass Doors



Interior Wire Management



Electronic Media Compartment
with Wire Management

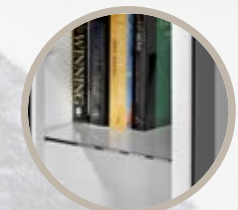

Glass Shelves

The Anya

The Anya Electric Fireplace Entertainment Package is stylishly modern, complete with a black glossy finish and a clean lined silhouette. Featuring a smoked glass top and doors that complement the sparkling glass ember bed, specifically built for the Cinema™ Glass 27 Electric Fireplace. Ideal for all of your entertainment needs, add warmth and class to any space without the need of a renovation.



53" w x 20 3/4" d x 24 4/5" h
(NEFP27-3116B)

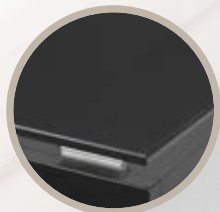

10mm tempered smoked glass top



Curved smoked glass push doors

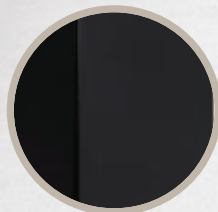

Gloss black finish



Electronic Media Compartment with Wire Management



Can be used independently as a NIGHT LIGHT™



Comes with the Cinema™ Glass 27 (See Pages 8-9 for firebox details)

The Foley

The presence of the Foley in sleek black sets an memorable presence in any room, adapting to any room style. The simple, clean lines and minimalistic appearance allow the Foley to fuse into and elevate the current room feel. The darkened finish really allows the Cinema™ Glass 27 firebox to illuminate and demand attention from anywhere in the room.



60" w x 18" d x 32" h
(NEFP27-1015B)



Comes with the Cinema™ Glass 27
(See Pages 8-9 for firebox details)

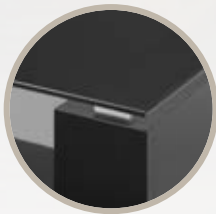

Smoke Tempered Glass Top

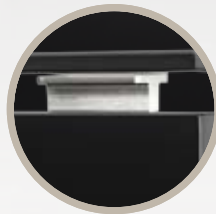

Brushed Aluminum
Rectangular Accent Posts



Smoke Tempered
Glass Doors

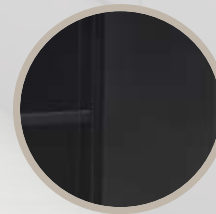

Semi Gloss Finish



Can be used independently
as a NIGHT LIGHT™

The Crawford

Napoleon's Essential Series modern Crawford entertainment package, comes complete with the stunning Cinema™ Glass 27 firebox. The presence of this sleek black electric fireplace entertainment unit adapts to any room style and the darkened finish really allows the firebox to illuminate and demand attention from anywhere in the room.

54" w x 18" d x 39" h
(NEFP27-1116B)



Decorative Glass Door



Motion Sensor LED Lights

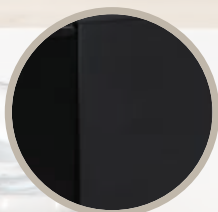

Gloss black finish



Electronic Media Compartment
with Wire Management

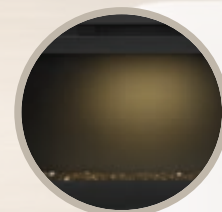

Can be used independently
as a NIGHT LIGHT™



Comes with the Cinema™ Glass 27
(See Pages 8-9 for firebox details)

The Whitney

A deep grey wash finish makes The Whitney Electric Fireplace Mantel Package stand out from the rest. Coming complete with the Cinema™ Glass 24 Electric Fireplace, this mantel package is modern and subdued, blending perfectly into your space. The transitional design makes it perfect for any room, living, dining, and anything in between.

60" w x 18" d x 32" h
(NEFP24-0516GRW)



Comes with the Cinema™ Glass 27
(See Pages 8-9 for firebox details)



10mm tempered glass top

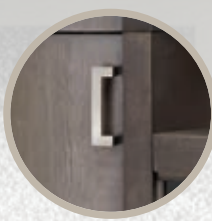

Luxurious handles



Deep grey wash finish



Electronic media storage



Can be used independently
as a NIGHT LIGHT™

The Braxton

The Braxton has a modest footprint while housing the largest electric firebox in the Cinema™ family at 29 inches. Solid hardwood decorative side columns hold a black granite styled surround around the impressive 29" wide Cinema™ fireplace. A hidden compartment allows you to hide any possessions within or use it to hold electronic media components with the wire management system found inside.

50" w x 15" d x 40" h
(NEFP29-1215BW)

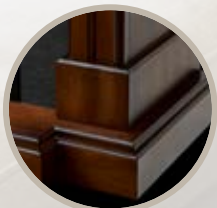

Pedestal Base



Solid Hardwood Decorative Side Columns

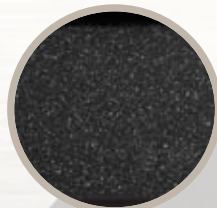

Black Granite Styled Surround

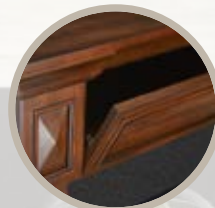

Convenient Hidden Compartment for Media Components



Can be used independently as a NIGHT LIGHT



Comes with the Cinema™ 29 (See Pages 6-7 for firebox details)

The Bailey

The Bailey may be humble in size for small areas but produces substantial impact of ambience. The Bailey comes in an Espresso finish for a rich look and feel. The solid hardwood decorative side columns create pleasing lines and frame the Cinema™ 24 firebox which sits upon a ledge, effortlessly inviting the attention of your guests.

38" w x 13" d x 34" h
(NEFP24-0116E)



Comes with the Cinema™ 24
(See Pages 6-7 for firebox details)

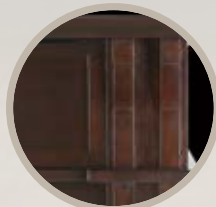

Solid Hardwood Decorative
Side Columns

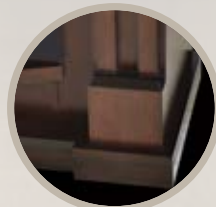

Pedestal Base

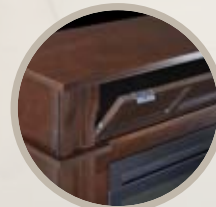

Convenient Hidden Compartment
for Media Components



Option to transform into
Corner Unit

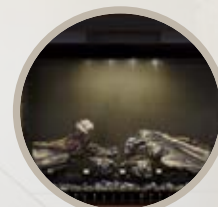

Can be used independently
as a NIGHT LIGHT

THE HOME SHOULD TELL THE STORY OF WHO YOU ARE AND BE A COLLECTION OF WHAT YOU LOVE.

PRESTIGE ENTERTAINMENT PACKAGES COLLECTION

Napoleon Prestige Entertainment Packages are very modern and both the Alanis and the Shelton packages offer a variety of features and functions. Give your home a refreshing new look with one of the Prestige Series Entertainment Packages, complete with Napoleon's Allure™ Phantom 42. The unique firebox contains a mesh front and matte surround which eliminates distracting reflections caused by a glass front.

For detailed mantel specifications visit our website: www.napoleonfireplaces.com

LOW ENERGY
LED
HIGH INTENSITY

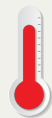

Heats up to
400 sq. ft.

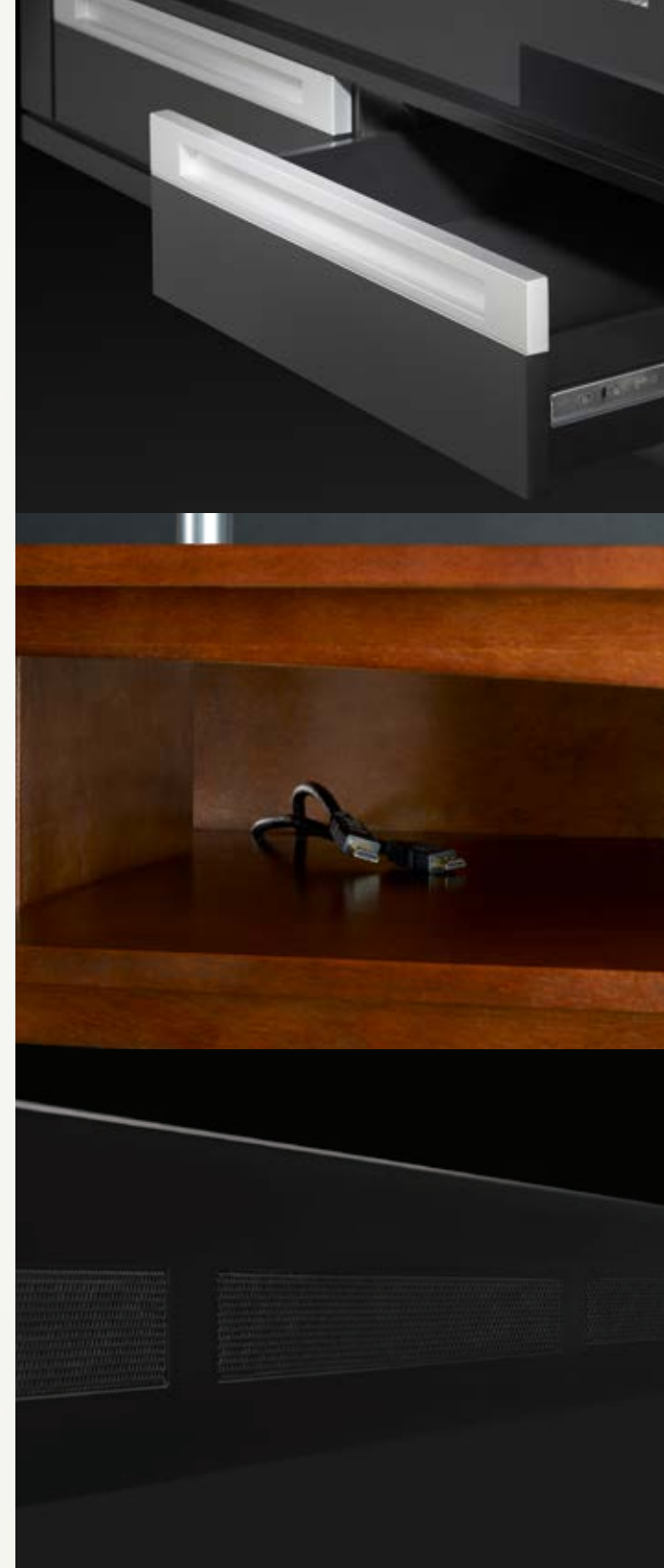

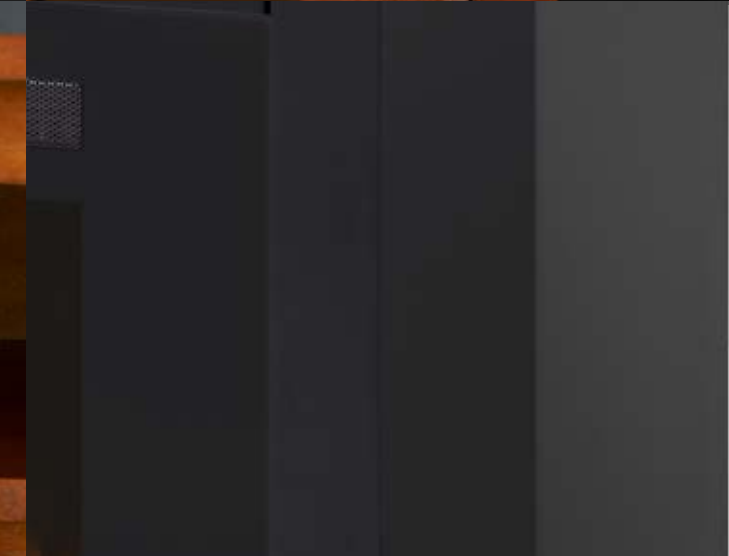

The Shelton

Add class and style with this fresh, yet classic entertainment package, stylish, sleek and modern but boasts enough heat to allow it to feel comfortable in traditional spaces as well. It comes with everything you need to create a warm and cozy atmosphere, as well as storage for all of your media equipment. With the included Allure™ Phantom 42 Electric Fireplace, transform any room in an instant.

60" w x 19 11/16" d x 34" h
(NEFP42-1715BW)



Brushed Aluminum Round Accent Posts

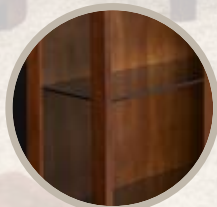

Glass Shelves

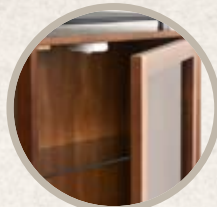

90 Degree Side Swing Doors

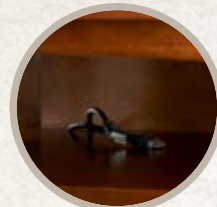

Convenient Hidden Compartment for Media Components

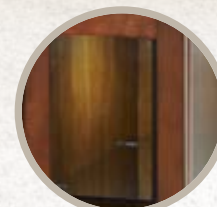

Motion Sensor LED Lights



Comes with the Allure™ Phantom 42 (See wall-mount brochure for details)

The Alanis

If you are looking for a modern addition to your space, look no further than the Alanis Entertainment Package. Sleek, black, and modern with silver accents, this mantel is the perfect media storage and fireplace solution. This mantel package includes the Allure™ Phantom 42 Electric Fireplace. At 54-inches wide and only 18-inches deep, the Alanis is large enough to add drama to a space without being imposing.

54" w x 18" d x 39" h
(NEFP42-1815B)



Comes with the Allure™ Phantom 42
(See wall-mount brochure for details)



Silver Accented Drawers



Convenient Compartment
for Media Components

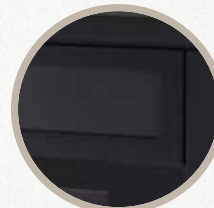

Framed glass door for
media compartment



Electronic Media Compartment with
Wire Management System



Sleek Black Finish



NAPOLEON - CELEBRATING OVER 40 YEARS OF HOME COMFORT PRODUCTS



24 Napoleon Road, Barrie, Ontario, Canada L4M 0G8
103 Miller Drive, Crittenden, Kentucky, USA 41030
7200 Trans Canada Highway, Montreal, Quebec, Canada H4T 1A3

Tel: 1-866-820-8686
napoleonfireplaces.com

Authorized Dealer



Consult your owner's manual for complete installation instructions, accurate framing dimensions and proper clearances to combustible material. Check all local and national building codes. All specifications are subject to change without prior notice due to on-going product improvements. Products may not be exactly as shown. Napoleon is a registered trademark of Wolf Steel Ltd. © Wolf Steel inc.

NAPOLEON

GAS BURNING INSERTS & VENTED LOGSETS



GAS BURNING INSERTS & VENTED LOGSETS
napoleon.com



Find your happy (fire)place.

Throughout the ages, people have gathered around fires to share in life's greatest joys. There's just something about the glow of flickering flames that makes special moments feel even warmer.

A Napoleon fireplace is uniquely designed to brighten the vibe of any room in your house. Napoleon has an incredible range of designer options to fit any vision.

A fire not only raises the warmth and ambiance of a room, it can raise the value of your home. A fireplace offers some of the highest returns of any remodeling project. And that should make you feel good all over.

And so you can keep enjoying that positive glow for years and years and years to come, every Napoleon fireplace is backed by the President's Limited Lifetime Warranty.

- Oakville™ 3 - GDI3 4 - 5
- Oakville™ 3 Glass - GDIG3 6 - 7
- Oakville™ X3 - GDIX3 8 - 9
- Oakville™ X4 - GDIX4 10- 11
- Roxbury™ 30 - GDI-30..... 12 - 13
- Roxbury™ 3600 - GI3600..... 14 - 15
- Inspiration™ ZC - GDIZC 16 - 17
- Fiberglow™ Log Series - GL18/24/30E 18 - 19
- Verso™ Log Series - GL22/28/32 20 - 21
- Napoleon's Outstanding Features 22 - 23
- Detailed Specifications & Line Drawings 24 - 27



Cover Photo - Oakville™ X4 shown with Small Arched 4-Sided Black Faceplate, Medium 3-Sided Backerplate and Newport™ Decorative Brick Panels.



Napoleon's Hot Spots Research Study delivers insights on key areas of the home. In particular, how to help you add relaxation, social interaction and functionality to rooms to enhance your memorable moments.

Throughout this brochure we will share some of our insights with you. For more inspiration visit napoleonfireplaces.com/inspiration.



Oakville X3 shown with Small Arched 4-Sided Black Faceplate and Large 3-Sided Backerplate

Oakville™ 3

Style, Comfort and Efficiency

The Napoleon Oakville™ 3 Gas Fireplace Insert offers many standard features including a premium SPLIT OAK log set and "H" style burner that produces a full firebox of flames! The clean face design, flush finish accessories and endless design opportunities makes this perfect for smaller living spaces. The Oakville™ 3 is great for home owners who want the cost saving benefits of Zone Heating (heating the room you use the most) plus the benefit of replacing an old drafty masonry fireplace with an efficient heating source.

Features & Options



Premium Split Oak Logset (included)



Small 3-Sided Faceplates
Available in 4 finishes*
For use with the 3-sided backerplates



Small 4-Sided Faceplates
Available in 4 finishes*
For use with the 3 or 4-sided backerplates



Large 3-Sided Faceplates
Available in 4 finishes*
For use with the 3-sided backerplates



Large 4-Sided Faceplates
Available in 4 finishes*
For use with the 4-sided backerplate



Small Arched 4-Sided Faceplates
Available in 4 finishes*
For use with the 3-sided backerplates



Cast Iron Surround



3-Sided Backerplates
Available in black
Available in Small, Medium & Large



4-Sided Backerplate
Available in Large



*Four Finish Options
Charcoal, Copper, Gun Metal and Black





GDI3

Up to 24,500 BTU's
Viewing Area: 22 11/16" W x 15" H
For more detailed specifications
on this unit, see page 24



MIRRO-FLAME™ Porcelain Reflective Radiant Panels (optional)



Old Town Red™ Brick Panels (optional)



Westminster™ Brick Panels (optional)



Newport™ Standard Brick Panels (optional)

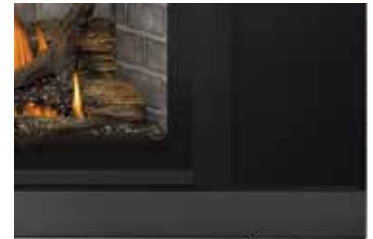

Riser Box (optional)



Blower Kit (optional)



Remote Controls (optional)

Oakville™ 3 shown with Large 4-Sided Gun Metal Faceplate, Large 4-Sided Backerplate and Old Town Red™ Brick Panels.

Oakville™ 3 Glass

Economical Modern Elegance

With all the features of the Oakville™ 3 plus Napoleon's exclusive NIGHT LIGHT™ and MIRRO-FLAME™ Porcelain Reflective Radiant Panels, the Oakville™ 3 **Glass** is the perfect solution for an economical heating source complemented with the modern elegance of a sparkling Topaz CRYSTALINE™ ember bed. A multitude of decorative designer accessories are also available to match any room in your home. Heating smarter and saving energy doesn't have to mean compromising great design.

Features & Options



Topaz CRYSTALINE™ Ember Bed (included)
Glass Embers also available in: Amber, Black, Blue, Clear and Red



Clear Glass Beads (optional)
Glass Beads also available in: Amber, Black, Blue, Clear and Red



Small 3-Sided Faceplates
Available in 4 finishes*
For use with the 3-sided backerplates



Small 4-Sided Faceplates
Available in 4 finishes*
For use with the 3 or 4-sided backerplates



Large 3-Sided Faceplates
Available in 4 finishes*
For use with the 3-sided backerplates



Large 4-Sided Faceplates
Available in 4 finishes*
For use with the 4-sided backerplate



Small Arched 4-Sided Faceplates
Available in 4 finishes*
For use with the 3-sided backerplates



Cast Iron Surround



3-Sided Backerplates
Available in black
Available in Small, Medium & Large



4-Sided Backerplate
Available in Large



*Four Finish Options
Charcoal, Copper, Gun Metal and Black





GDIG3

Up to 24,000 BTU's
Viewing Area: 22 11/16" W x 15" H
For more detailed specifications
on this unit, see page 24

Oakville 3 Glass shown with Small 3-Sided Black Faceplate, Large 3-Sided Backerplate and MIRRO-FLAME™ Porcelain Reflective Radiant Panels.



MIRRO-FLAME™ Porcelain Reflective Radiant Panels (included)



Riser Box (optional)



Blower Kit (optional)



eFIRE Enabled With App (included)



Remote Control (included)

Oakville™ X3

Radiant Warm Glow

The Oakville™ X3 is a deluxe Gas Fireplace Insert which offers the same features as the Oakville™ 3 as well as a thermostatic remote, an exclusive NIGHT LIGHT™ that radiates a warm glow throughout the room, even when the fireplace is off and additional BTU's for added heat. Directional baffles increase air flow to help drive the heat into your home for maximum efficiency. The perfect solution for replacing and updating an inefficient old masonry setting. PLUS this insert comes equipped with eFIRE Bluetooth technology for your added convenience.

Features & Options



Premium Split Oak Logset
(included)



Small 3-Sided Faceplates
Available in 4 finishes*
For use with the 3-sided backerplates



Small 4-Sided Faceplates
Available in 4 finishes*
For use with the 3 or 4-sided backerplates



Large 3-Sided Faceplates
Available in 4 finishes*
For use with the 3-sided backerplates



Large 4-Sided Faceplates
Available in 4 finishes*
For use with the 4-sided backerplate



Small Arched 4-Sided Faceplates
Available in 4 finishes*
For use with the 3-sided backerplates



Cast Iron Surround



3-Sided Backerplates
Available in black
Available in Small, Medium & Large



4-Sided Backerplate
Available in Large



*Four Finish Options
Charcoal, Copper, Gun Metal and Black





GDIX3

Up to 30,000 BTU's
Viewing Area: 22 11/16" W x 15" H
For more detailed specifications
on this unit, see page 24

Oakville™ X3 shown with Large 4-Sided Black Faceplate and MIRRO-FLAME™ Porcelain Reflective Radiant Panels.



MIRRO-FLAME™ Porcelain Reflective Radiant Panels (optional)



Old Town Red™ Brick Panels (optional)



Westminster™ Brick Panels (optional)



Newport™ Standard Brick Panels (optional)

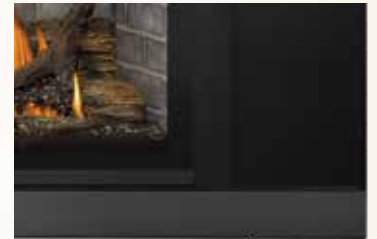

Riser Box (optional)



Blower Kit (optional)



Remote Control (included)



eFIRE Enabled With App (included)

Oakville™ X4

Stunning Triple Flame Pattern

The largest in the Oakville™ Series the impressive Oakville™ X4 Gas Fireplace Insert has an exclusive dual burner split flow system that results in a firebox filled with a stunning triple flame pattern, and allows the option of independently operating the front and rear burners from 16,000 to 40,000 BTU's. A superior heat circulating blower comes included with this model and when paired with the Oakville™'s air flow improvement directional baffles generates maximum blower efficiency. A stunning triple flame and massive 518 sq. in. viewing area makes this fireplace insert a perfect choice for larger rooms where a passion for luxury is evident.

Features & Options



Premium Split Oak Logset
(included)



Small 3-Sided Faceplates
Available in 4 finishes*
For use with the 3-sided backerplates



Small 4-Sided Faceplates
Available in 4 finishes*
For use with the 3 or 4-sided backerplates



Large 3-Sided Faceplates
Available in 4 finishes*
For use with the 3-sided backerplates



Large 4-Sided Faceplates
Available in 4 finishes*
For use with the 4-sided backerplate



Small Arched 4-Sided Faceplates
Available in 4 finishes*
For use with the 3-sided backerplates



3-Sided Backerplates
Available in black
Available in Small, Medium & Large



4-Sided Backerplate
Available in Large



*Four Finish Options
Charcoal, Copper, Gun Metal and Black





GDIX4

Up to 40,000 BTU's

Viewing Area: 27 3/4" W x 18 11/16" H

For more detailed specifications on this unit, see page 25



MIRRO-FLAME™ Porcelain Reflective Radiant Panels (optional)



Old Town Red™ Brick Panels (optional)



Westminster™ Brick Panels (optional)



Newport™ Standard Brick Panels (optional)

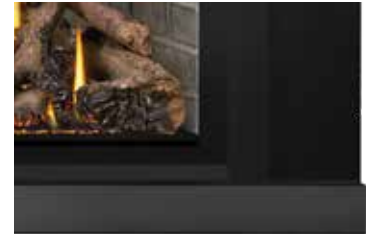

Riser Box (optional)



Blower Kit (included)



Napoleon's Hot Spots Research Study divulges how over 90% of people surveyed strongly desire a fireplace in the family / living room.



Remote Control (included)



eFIRE Enabled With App (included)

The Oakville™ X4 shown with Large 4-Sided Gunmetal Faceplate and 4-Sided Backerplate

Roxbury™ 30

An Elegant Heater For Any Lifestyle

The Roxbury™ 30 easily transforms your existing masonry or prefabricated fireplace into an efficient heating source, eliminating drafts and ultimately saving you money. Napoleon's exclusive PHAZER® logs, charcoal embers, heat activated variable speed blower system, realistic YELLOW DANCING FLAMES® and elegant designer options turn your room into a tranquil getaway. The state-of-the-art pan burner system guarantees a wide range of heat output with adjustable flame/heat control giving you the heat you need with a traditional masonry look and feel.

Features & Options



Andirons Painted Black



F45 & F60 Remote Controls On/Off



Louvres Four Color Options



Cast Iron Surrounds Two Finish Options



Sandstone Brick Panels



MIRRO-FLAME™ Porcelain Reflective Radiant Panels



Mineral Rock Kit



Black Surround



Brushed Stainless Surround



Deluxe Black 6" Flashing



Deluxe Black 9" Flashing



Black Bevelled 6" Flashing



Arched Black Cast Iron Surround





GDI-30

Up to 24,500 BTU's

Viewing Area: 30 1/16" W x 21 3/4" H

For more detailed specifications on this unit, see page 26

Roxbury™ 3600

Economical & Versatile

Here's the secret to a warmer, cozier home! Retrofit your drafty old fireplace with this beautiful Napoleon gas insert. The Roxbury™ 3600 is especially designed to fit smaller wood burning, zero clearance fireplaces and comes complete with a heat activated variable speed blower system. Create the exact designer touch you have been looking for with optional choices including flashings and surrounds available in various styles and finishes.

Features & Options



Andirons Painted Black



F45 & F60 Remote Controls On/Off



Louvres Four Color Options



Cast Iron Surrounds Two Color Options



Decorative Sandstone Brick Panels



MIRRO-FLAME™ Porcelain Reflective Radiant Panels

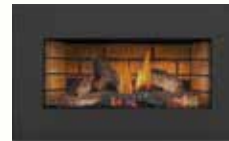

Painted Black Surround



Brushed Copper Surround



Brushed Copper Surround with Deluxe Black 6" Flashing



Black 9" Flashing



Black Bevelled 6" Flashing



Arched Black Cast Iron Surround



Fire and light have served as a beacon for centuries, visitors get a feeling of warmth and hospitality.

GI3600

Up to 24,000 BTU's

Viewing Area: 25" W x 22" H

For more detailed specifications on this unit, see page 26

Inspiration™ ZC

Smallest Fireplace Opening, Large Viewing Area

The multi-level advanced burner technology of the Inspiration™ ZC produces beautiful, realistic YELLOW DANCING FLAMES® and the exclusive PHAZER® log set and charcoal ember bed are so realistic, they will be mistaken for a real wood fire. This award winning gas insert is designed to fit the smallest fireplace openings but offers a large ceramic glass viewing area. The Inspiration™ ZC comes complete with a heat activated variable speed blower system making it the perfect gas insert for any room in your home.

Features & Options



Andirons Painted Black



F45 & F60 Remote Controls On/Off



Cast Iron Surrounds Two Finish Options



Decorative Sandstone Brick Panels



MIRRO-FLAME™ Porcelain Reflective Radiant Panels



Painted Black Surround



Brushed Stainless Surround



Contemporary Black Trim



Textured Satin Black 3 Sided Aluminum Trim



Black 3 Sided Flashing



Black 4 Sided Flashing





GDIZC

Up to 24,000 BTU's

Viewing Area: 25" W x 14 1/2" H

For more detailed specifications on this unit, see page 25

Fiberglow™ Vented Gas Log Sets

Ambiance Your Home Deserves

No need to split and haul wood to your masonry fireplace, simply add a realistic Napoleon Gas Log Set. In today's demanding society where life never seems to slow down, we crave the simple pleasures that bring back relaxation, comfort and treasured times with family and friends. Napoleon's gas log sets feature an electronic ignition, a clean burning infrared radiant heat burner system and are available in three sizes.

Features & Options



F45 & F60 Remote Controls On/Off

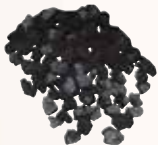

Lava Rocks / Cinders (included)



Cast Iron Grate (included)



GL18E - 18" Log Set

Up to 55,000 BTU's
16" H x 20 3/8" W x 13 1/4" D



GL24E - 24" Log Set

Up to 60,000 BTU's
16" H x 26" W x 13 1/4" D



GL30E - 30" Log Set

Up to 65,000 BTU's
16" H x 30" W x 13 1/4" D

For more detailed specifications on these units, see page 27

***VENT FREE LOG SETS ALSO AVAILABLE.**
Vent free appliances not approved in Canada and some states.





Fiberglow™ 18 shown with Grate, Andirons, Lava Rocks and Cinders.



Fiberglow™ 30 shown with Grate, Andirons, Lava Rocks and Cinders.

Verso™ Vented Gas Log Sets

Two Looks In One

Napoleon's Reversible Gas Log Sets can be configured for an authentic looking split-wood fire, a natural looking tree bark appearance or a combination of both. Featuring massive flames, reversible PHAZER™ logs, electronic ignition with battery back-up and high heat output, your fireplace will look like a real wood burning fireplace without the work and maintenance of using real wood. The burner pan is adjustable to allow more glowing embers to be seen. Controls are hidden but easy to access, and an optional remote control or remote wall switch are available for added convenience.



Charcoal Lumps, Charcoal Embers & Glowing Embers (included)



F45 On/Off Remote Control



Remote Control Kit
F45 remote, receiver, batteries, remote cradle and two ceramic fibre logs Two Color Options



Natural Tree Bark (side one)



Authentic Split Wood (side two)



GL22 - 22" Log Set

Up to 70,000 BTU's
6 11/16" H x 22" W x 11 3/8" D



GL28 - 28" Log Set

Up to 80,000 BTU's
6 7/8" H x 28" W x 11 3/8" D



GL32 - 32" Log Set

Up to 90,000 BTU's
6 7/8" H x 32" W x 11 3/8" D

For more detailed specifications on these units, see page 27





Verso™ 28 shown with Natural Tree Bark side, Charcoal Embers, Glowing Embers and Charcoal Lumps.



Verso™ 32 shown with Authentic Split-Wood side, Charcoal Embers, Glowing Embers and Charcoal Lumps.

Outstanding Features

of Napoleon's Advanced Technology



Advanced Burner Technology

Napoleon's sophisticated burner system offers superior flame technology. Strategically placed burner ports create the most realistic YELLOW DANCING FLAMES® in the industry.

Finely Tuned Precision Valves

Surrounded with a protective cast aluminum jacket, the precision valves allow for ultimate reliability and 100% SAFE GUARD™ gas control system.

Minimum 30% savings on heating costs with Zone Heating



Zone Heating means you are heating the rooms that you use the most with an alternate heat source, like a Napoleon gas fireplace insert. Zone Heating is the obvious solution for families concerned about rising fuel costs.

Outstanding Craftsmanship

Fine details are designed in every aspect of Napoleon fireplaces... individually handcrafted with pride of excellence to last a lifetime.

Safety Screens

Napoleon, leaders in design & technology have developed premium safety screens that are minimally visible and therefore aesthetically pleasing for every gas appliance to ensure ultimate safety and peace of mind for you and your family.

Outstanding Features of Napoleon's Fiberglow™ Gas Log Sets

1. Air flows towards the air intake opening.
2. Natural gas or propane flow into a precisely calibrated SIT safety valve.
3. Air and fuel mix within the venturi tube.
4. The perfect blend of fuel and air mixture travels through the burner ports, strategically placed to begin the process of creating the most realistic flames in the industry.
5. Infrared heat from the exclusive PHAZERAMIC™ burner and ember bed provides up to 65,000 BTU's (GL30E).
6. Infrared heat technology and curved rear log design directs heat back into the room.
7. Controls are hidden from view but easy to access. The added feature of an on/off switch is conveniently located at the front side.
8. Flame sensor provides 100% SAFE GUARD™ system, quickly and automatically shutting off the gas supply for your peace of mind.
9. Electronic ignition with battery back-up ensures reliability without the need for electricity.
10. Ignition system is easy to operate with a digital remote control, wall switch or wall thermostat.

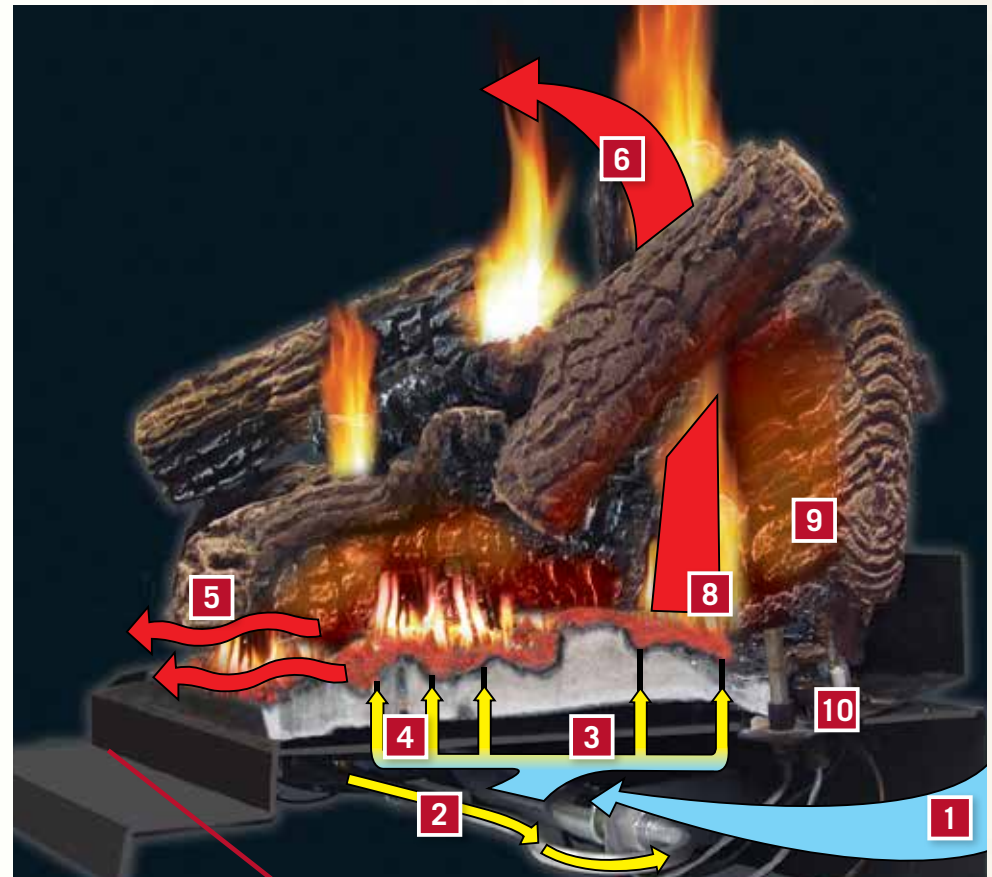

Oakville™ 3

Shown on pages 4 - 5

*Accessories may change unit dimensions

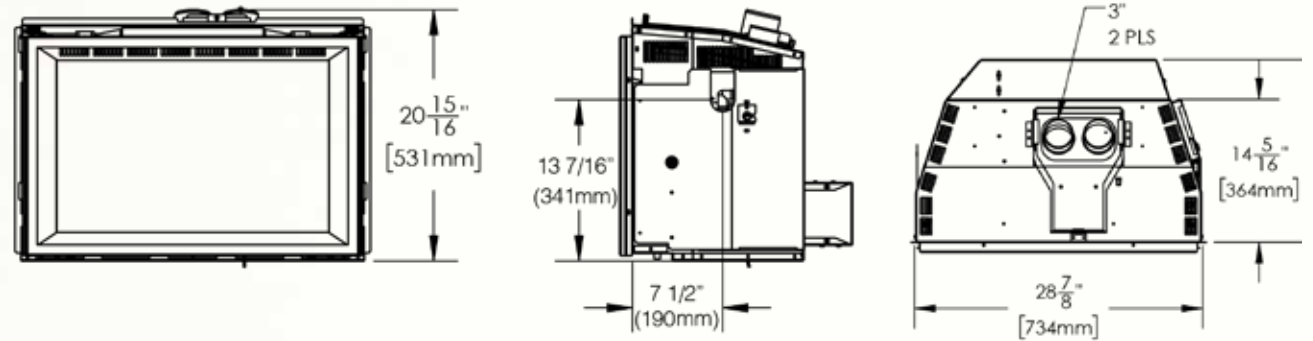

Model	BTU's (Input)	Venting 3" x 3"	Height		Front Width		Depth		Glass Type	Viewing Area		Efficiencies		Blower	Mobile Home Certified	Electronic Ignition
			Actual	Minimum Opening	Actual	Minimum Opening	Actual	Minimum Opening		Height	Width	EnerGuide	Steady State			
GDI3	24,500	Top	20 15/16"	21 1/2"	28 5/8"	29"	14 3/8"	14 3/8" *	Ceramic	15"	22 11/16"	55%	55.22%	Optional	Yes	No

* Must add 4" (102mm) for optional blower
Certified under Canadian and American National Standards.

Oakville™ 3G & X3

Shown on pages 6 - 9

*Accessories may change unit dimensions

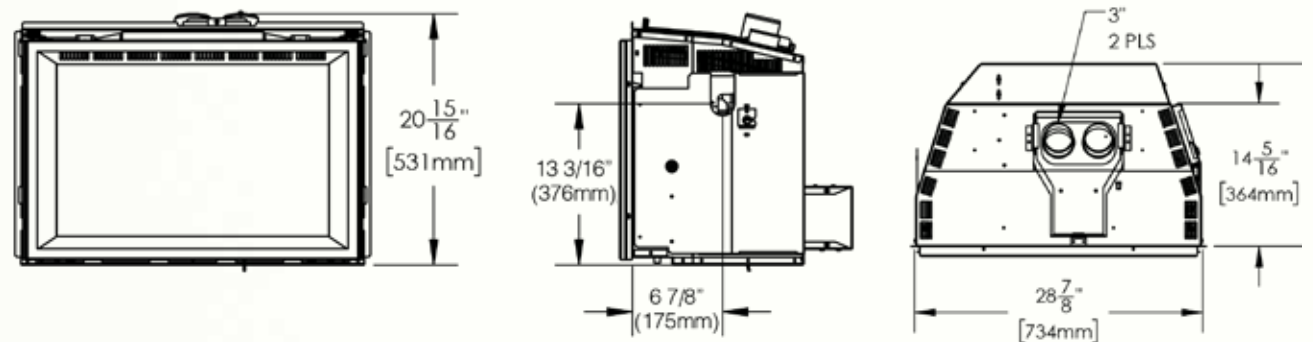

Model	BTU's (Input)	Venting 3" x 3"	Height		Front Width		Depth		Glass Type	Viewing Area		Efficiencies		Blower	Mobile Home Certified	Electronic Ignition
			Actual	Minimum Opening	Actual	Minimum Opening	Actual	Minimum Opening		Height	Width	EnerGuide	Steady State			
GDIG3	24,000	Top	20 15/16"	21 1/2"	28 5/8"	29"	14 3/8"	14 3/8" *	Ceramic	15"	22 11/16"	61.7%	66.42%	Optional	Yes	Yes
GDIX3	30,000	Top	20 15/16"	21 1/2"	28 5/8"	29"	14 3/8"	14 3/8" *	Ceramic	15"	22 11/16"	61.8%	66.84%	Optional	Yes	Yes

* Must add 4" (102mm) for optional blower
Certified under Canadian and American National Standards.

Figures may vary with individual conditions such as floor plan layout, insulation value/heat loss of the house and geographical location.
Measurements to be used as a guide only. Consult your owner's manual for complete and up-to-date installation instructions and proper clearances to combustible materials.

Oakville™ X4

Shown on pages 10 - 11

*Accessories may change unit dimensions

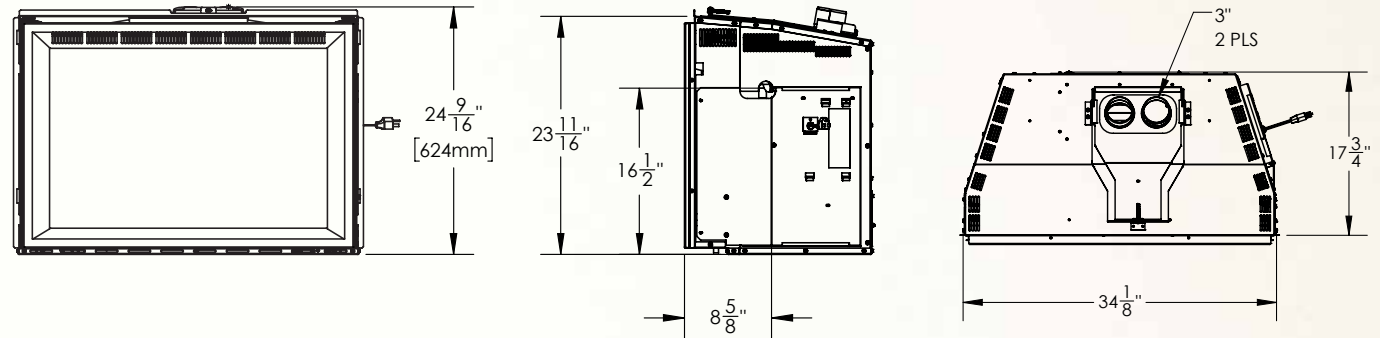

Model	BTU's (Input)		Venting 3" x 3"	Height		Front Width		Depth		Glass Type	Viewing Area		Efficiencies		Blower	Mobile Home Certified	Electronic Ignition
				Actual	Minimum Opening	Actual	Minimum Opening	Actual	Minimum Opening		Height	Width	EnerGuide	Steady State			
GDIX4	40,000		Top	24 9/16"	24 3/4"	34 1/8"	34 5/16"	18 3/4"	18 15/16" *	Ceramic	18 11/16"	27 3/4"	61.5%	66.23%	Included	Yes	Yes

* Must add 4" (102mm) for optional blower
Certified under Canadian and American National Standards.

Inspiration™ ZC

Shown on pages 16 - 17

*Accessories may change unit dimensions

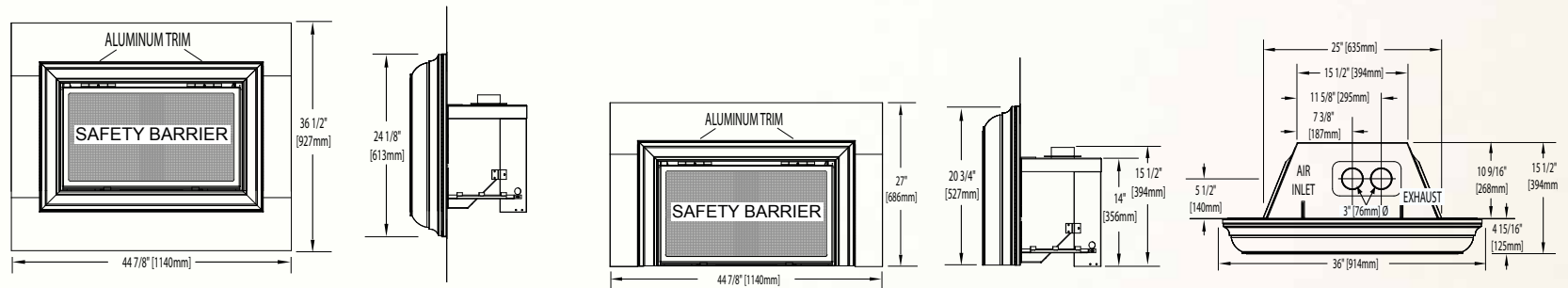

Model	BTU's (Input)		Venting	Height			Front Width		Depth		Glass Type	Viewing Area		Efficiencies			Blower	Mobile Home Certified	Electronic Ignition
	Natural Gas	Propane		Actual (Three- Sided)	Actual (Four- Sided)	Minimum Opening	Actual	Minimum Opening	Actual	Minimum Opening		Height	Width	EnerGuide	AFUE	Steady State			
GDIZC	14 - 24,000	15 - 24,000	Top	20 3/4"	24 1/8"	14 1/2"	36"	25"	15 1/2"	11"	Ceramic	15 5/8"	28 1/8"	65.5%	65%	85%	Included	Yes	No

Certified under Canadian and American National Standards.

Figures may vary with individual conditions such as floor plan layout, insulation value/heat loss of the house and geographical location. Measurements to be used as a guide only. Consult your owner's manual for complete and up-to-date installation instructions and proper clearances to combustible materials.

Roxbury™ 30

Shown on pages 12 - 13

*Accessories may change unit dimensions

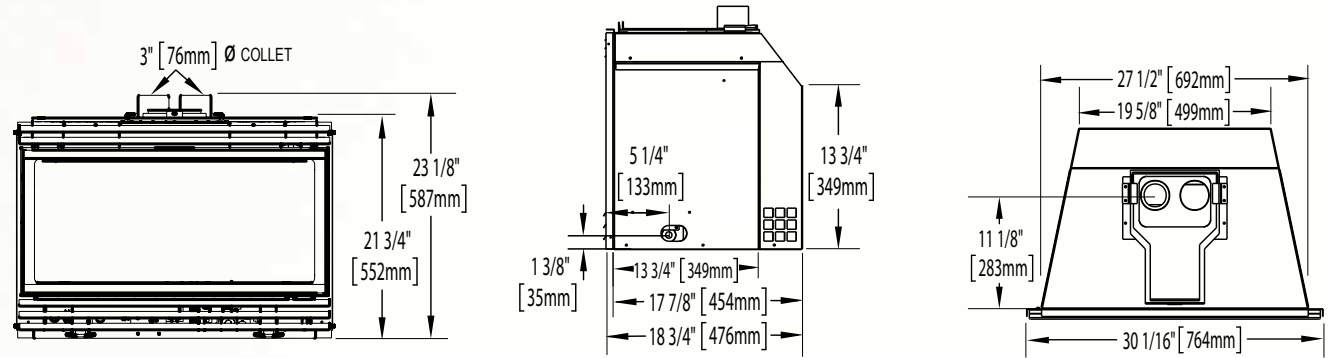

Model	BTU's (Input)		Venting	Height		Front Width		Depth		Glass Type	Viewing Area		Efficiencies			Blower	Mobile Home Certified	Electronic Ignition
	Natural Gas	Propane		Actual	Minimum Opening	Actual	Minimum Opening	Actual	Minimum Opening		Height	Width	EnerGuide	AFUE	Steady State			
GDI-30	15 - 24,500	19 - 24,500	Top	21 3/4"	22"	30 1/16"	28"	17 7/8"	18"	Ceramic	13 5/16"	27 7/8"	64.5%	60.02%	85%	Included	Yes	No

Certified under Canadian and American National Standards.

Roxbury™ 3600

Shown on pages 14 - 15

*Accessories may change unit dimensions

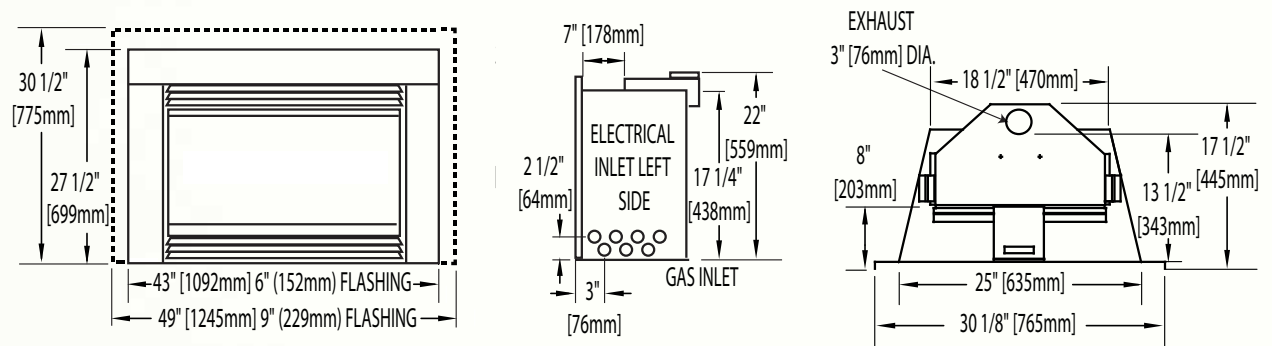

Model	BTU's (Input)		Venting	Height		Front Width		Depth		Glass Type	Viewing Area		Efficiencies			Blower	Mobile Home Certified	Electronic Ignition
	Natural Gas	Propane		Actual	Minimum Opening	Actual	Minimum Opening	Actual	Minimum Opening		Height	Width	EnerGuide	AFUE	Steady State			
GI3600	16 - 24,000	17 - 22,000	Top	17 1/4"	17 1/2"	25"	25 1/2"	17 1/2"	16 1/2"	Ceramic	11 3/4"	29 3/4"	62.3%	-	76%	Included	No	No

Certified under Canadian and American National Standards.

Figures may vary with individual conditions such as floor plan layout, insulation value/heat loss of the house and geographical location. Measurements to be used as a guide only. Consult your owner's manual for complete and up-to-date installation instructions and proper clearances to combustible materials.

Fiberglow™ Vented Gas Log Sets

Shown on pages 18 - 19

Model	Minimum Size Fireplace Opening		
	Height*	Width	Depth
18" GL18E	18"	22"	14"
24" GL24E	20"	28"	14"
30" GL30E	22"	34"	14"

*Allow 4-6" additional height for optimum flame appearance.
 Certified under Canadian and American National standards:
 CSA 2.26, ANSI Z21.60 decorative gas appliances for
 installation in solid-fuel burning appliances.

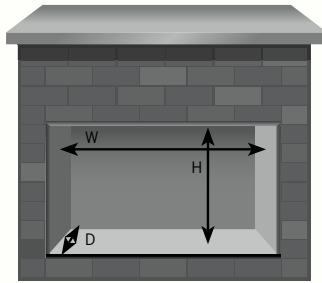

GL18E

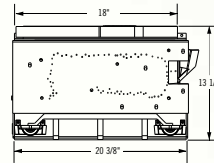

GL24E

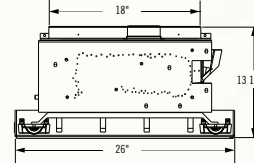

GL30E

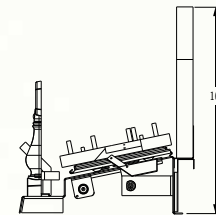
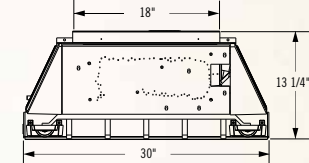

GL18E / GL24E / GL30E

Verso™ Vented Gas Log Sets

Shown on pages 20 - 21

Model	Minimum Size Fireplace Opening		
	Height	Width	Depth
22" GL22	20"	23"	14"
28" GL28	20"	29"	14"
32" GL32	22"	33"	14"

Certified under Canadian and American National standards:
 CSA 2.26, ANSI Z21.60 decorative gas appliances for
 installation in solid-fuel burning appliances.

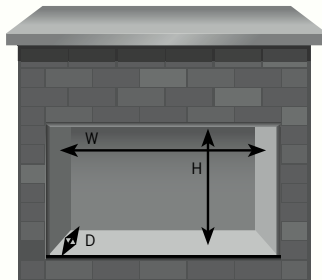

GL22

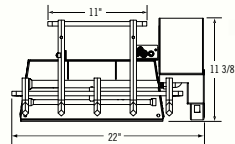

GL28

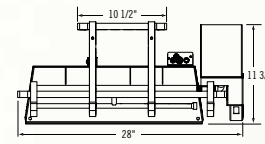

GL32

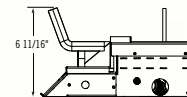
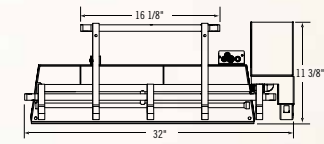

GL22

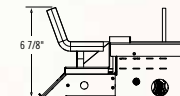

GL28 / GL32

Figures may vary with individual conditions such as floor plan layout, insulation value/heat loss of the house and geographical location.
 Measurements to be used as a guide only. Consult your owner's manual for complete and up-to-date installation instructions and proper clearances to combustible materials.



NAPOLEON - CELEBRATING OVER 40 YEARS OF HOME COMFORT PRODUCTS



24 Napoleon Road, Barrie, Ontario, Canada L4M 0G8
103 Miller Drive, Crittenden, Kentucky, USA 41030
7200 Trans Canada Highway, Montreal, Quebec, Canada H4T 1A3

Tel: 1-866-820-8686
napoleon.com



Authorized Dealer

Due to room reflections and printing processes, actual colors of fireplaces, finishes and accessories may vary slightly. Consult your owner's manual for complete installation instructions, accurate framing dimensions and proper clearances to combustible material. Check all local and national building codes. All specifications are subject to change without prior notice due to on-going product improvements. Products may not be exactly as shown. Napoleon is a registered trademark of Wolf Steel Ltd. © Wolf Steel inc.

NAPOLEON

GAS BURNING STOVES



GAS BURNING STOVES
napoleon.com



Find your happy (fire)place.

Throughout the ages, people have gathered around fires to share in life's greatest joys. There's just something about the glow of flickering flames that makes special moments feel even warmer.

A Napoleon fireplace is uniquely designed to brighten the vibe of any room in your house. Napoleon has an incredible range of designer options to fit any vision.

A fire not only raises the warmth and ambiance of a room, it can raise the value of your home. A fireplace offers some of the highest returns of any remodeling project. And that should make you feel good all over.

And so you can keep enjoying that positive glow for years and years and years to come, every Napoleon fireplace is backed by the President's Limited Lifetime Warranty.

Arlington™ - GDS20	4 - 5
Bayfield™ - GDS25.....	6 - 7
Castlemore™ - GDS26	8 - 9
Haliburton™ - GDS28	10 - 11
Havelock™ - GDS50	12 - 13
Knightsbridge™ - GDS60	14 - 15
Napoleon's Outstanding Features	16
Detailed Specifications & Line Drawings .	17 - 19

Cover Photo - Bayfield™ shown in Porcelain Enamel Majolica Brown Finish.





Napoleon's Hot Spots Research Study delivers insights on key areas of the home. In particular, how to help you add relaxation, social interaction and functionality to rooms to enhance your memorable moments.

Throughout this brochure we will share some of our insights with you. For more inspiration visit our inspiration gallery at Napoleon.com/fireplaces



Arlington™

Compact in Size - Huge in Style

The Arlington™ cast iron gas stove, with its slender, space saving design and 45° venting, is perfect for smaller rooms. The Arlington™ is available in metallic black or a porcelain enamel majolica brown finishes and includes MIRRO-FLAME™ Porcelain Reflective Radiant Panels. Even though small in size, it holds a large PHAZER™ burner system, PHAZER® log set and brightly glowing ember bed that can be viewed through the European styled ceramic glass viewing area.

Options & Accessories



F45 & F60 Remote Controls
On/Off with Digital Screen



MIRRO-FLAME™ Porcelain
Reflective Radiant Panels
(included)



Easy access hidden
control panel



45° venting for versatile
horizontal or vertical
installations



Porcelain Majolica Brown



Metallic Black Finish





GDS20

Up to 20,000 BTU's
19 1/4" W x 25 3/8" H

For more detailed specifications on this unit, see page 17

Bayfield™

Your Choice of Three Designer Colors

The Bayfield™ cast iron stove comes in three designer colors that will look great in any home or cottage. The built-in secondary heat exchanger provides excellent heating efficiency and heat retention. Other features include a cost saving electronic ignition with battery back-up, flame/heat adjustment, ceramic glass and an exclusive NIGHT LIGHT™ which creates a warm glow even when the stove is not on.



Porcelain Majolica Brown



Metallic Black Finish



Winter Frost Finish

Options & Accessories



Proflame II Remote Control (included)



MIRRO-FLAME™ Porcelain Reflective Radiant Panels



Built-in NIGHT LIGHT™





GDS25

Up to 24,500 BTU's
23 1/2" W x 25 5/8" H

For more detailed specifications on this unit, see page 17

Castlemore™

More Than Just a Reliable Heating Source

The Castlemore™ cast iron gas stove adds more than just a reliable heating source to your home. With its sleek curves and tall, slender stature, it becomes the ultimate focal point for any room. The Castlemore™ comes complete with Napoleon's exclusive NIGHT LIGHT™, PHAZERAMIC™ burner system, PHAZER® log set and glowing ember bed, creating a beautiful display of YELLOW DANCING FLAMES®. The classic European design will never go out of style and the heating power will provide a lifetime of enjoyable comfort.



Metallic Black Finish



Winter Frost



Majolica Brown Finish

Options & Accessories



Proflame II Remote Control (included)



MIRRO-FLAME™ Porcelain Reflective Radiant Panels



Decorative Sandstone Brick Panels



Easily converts from rear vent to top vent





The Living Room, Kitchen and Bedroom are prime targets for creating Hot Spots. If you get these rooms right, you've nailed it!



GDS26

Up to 25,000 BTU's
23 5/8" W x 35 1/2" H

For more detailed specifications on this unit, see page 18

Haliburton™

Dynamic Design, Environmentally Friendly Technology

Good things do come in small packages! If you have limited space but still desire the beauty and convenience of a gas stove... Napoleon's Haliburton™ is the answer! The Haliburton™ offers many benefits – a built-in blower, easily accessible control panel, solid body construction, a triple flame burner and a PHAZER® log set with glowing embers creating a beautiful display of YELLOW DANCING FLAMES®. Offering a variable heat range, as high as 30,000 BTU's, this stove may be compact in stature, but not in power!



Satin Chrome Door and Accent Bar



Metallic Black Door and Accent Bar

Options & Accessories



F45 & F60 Remote Controls
On/Off with Digital Screen



Andirons
Painted Black Finish

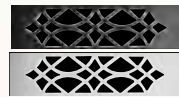

Trivets
Two Color Options



B-Vent Adapter Kits
See page 17 for details





GDS28

Up to 30,000 BTU's
22 1/2" W x 26 3/4" H

For more detailed specifications on this unit, see page 18

Havelock™

Sophisticated Heating Technology

This sophisticated gas stove comes complete with a built-in blower, extra large heat exchanger, easily accessible control panel and an advanced high tech, triple burner effect with a “furnace” type 44,000 BTU burner behind the logs. Acting as a “Turbo Boost” for those colder days & nights, it’s perfect for colder climates. All of the Havelock™ features combined with clean-burning, environmentally friendly technology, makes it the perfect choice to add long-lasting value to your home!

Options & Accessories



F45 & F60 Remote Controls
On/Off with Digital Screen



Andirons
Painted Black Finish



Trivet Painted Black



B-Vent Adapter Kits
See page 17 for details



Satin Chrome Door and Accent Bar



Black Door and Accent Bar





HOT SPOTS
RESEARCH STUDY

Napoleon's Hot Spots Research Study divulges how over 90% of people surveyed strongly desire a fireplace in the family / living room.

GDS50

Up to 44,000 BTU's
28 1/4" W x 30 3/4" H

For more detailed specifications on this unit, see page 19



Knightsbridge™

Solid Performance and Impressive Heating Efficiencies

Napoleon's Knightsbridge™ has always been in popular demand for its cast iron design, solid performance and impressive heating efficiencies. The Knightsbridge™ comes standard with Napoleon's PHAZER® log set, glowing embers, anti-condensation switch (controls pilot usage for cold climate installations) and electronic ignition with battery back-up. Its fine detailing and elegant cast iron design is a perfect complement to any home.



Metallic Black Finish



Porcelain Majolica Brown Finish

Options & Accessories



F45 & F60 Remote Controls
On/off or Modulating



Andirons
Painted Black Finish



Cast Iron Trivet
Painted Black Finish



B-Vent Adapter Kits
See page 17 for details



Decorative Sandstone
Brick Panels



GDS60

Up to 35,000 BTUs*

27" W x 30 1/2" H

For a detailed specifications on this unit, see page 19

*if stove is top vented

Outstanding Features

of Napoleon's Advanced Technology



Advanced Burner Technology

Napoleon's sophisticated burner system offers superior flame technology. Strategically placed burner ports create the most realistic YELLOW DANCING FLAMES® in the industry.

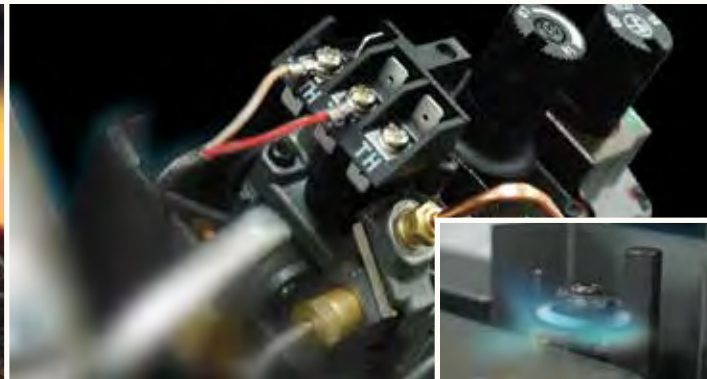

Finely Tuned Precision Valves

Surrounded with a protective cast aluminum jacket, the precision valves allow for ultimate reliability and 100% SAFE GUARD™ gas control system.

Minimum 30% savings on heating costs with Zone Heating

Zone Heating means you are heating the rooms that you use the most with an alternate heat source, like a Napoleon gas fireplace. Zone Heating is the obvious solution for families concerned about rising fuel costs.



Outstanding Craftsmanship

Fine details are designed in every aspect of Napoleon fireplaces... individually handcrafted with pride of excellence to last a lifetime.

Safety Screens

Napoleon, leaders in design & technology have developed safety screens with aesthetically pleasing designs for every gas appliance to ensure ultimate safety and peace of mind for your family.



Arlington™

Shown on pages 4 & 5

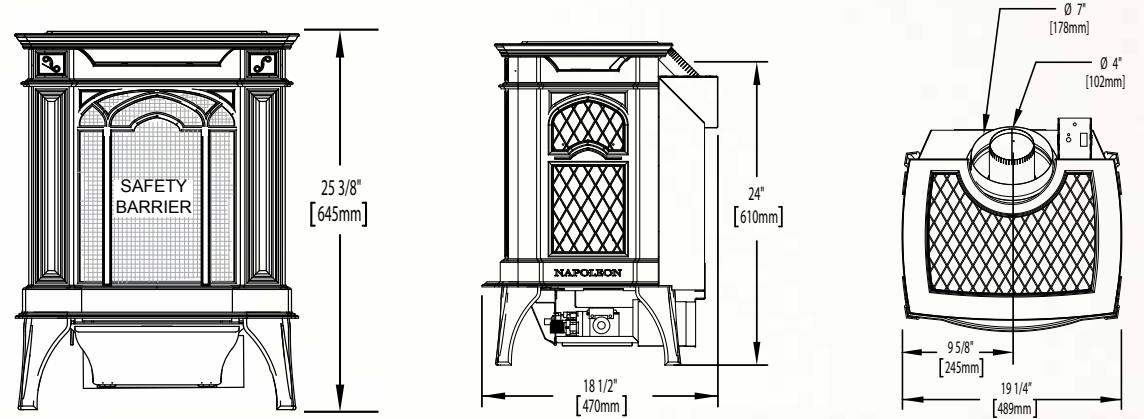

Model	BTU's (Input)		Venting	Height	Front Width	Depth	Glass Type	Glass Size		Efficiencies			Blower Kit	Mobile Home Certified	Electronic Ignition	Minimum Clearances to Combustibles		
	Natural Gas	Propane						Actual	Width	EnerGuide	AFUE	Steady State				Corner	Rear	Sides
GDS20	20,000	20,000	45°	25 3/8"	19 1/4"	18 1/2"	Ceramic	13"	14"	59.6%	-	78%	Optional	Yes	No	2"	2"	4"

Certified under Canadian and American National Standards.

Bayfield™

Shown on pages 6 & 7

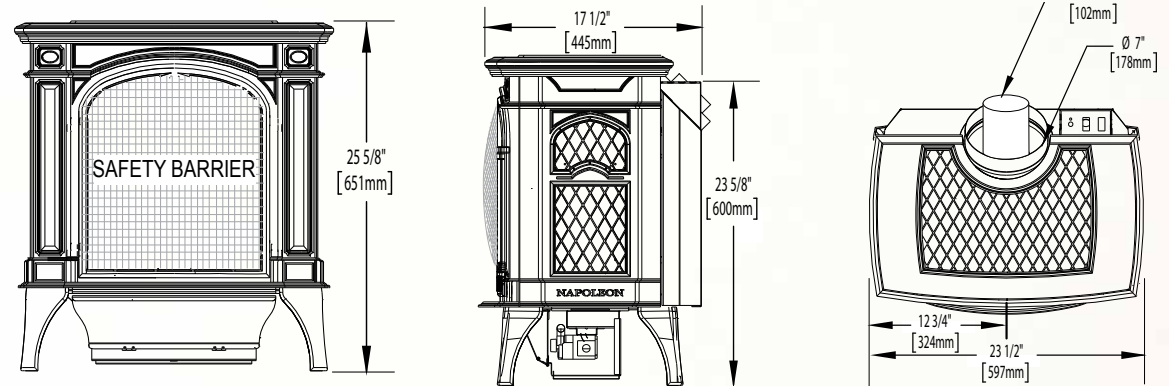

Model	BTU's (Input)		Venting	Height	Front Width	Depth	Glass Type	Glass Size		Efficiencies			Blower Kit	Mobile Home Certified	Electronic Ignition	Minimum Clearances to Combustibles		
	Natural Gas	Propane						Actual	Width	EnerGuide	AFUE	Steady State				Corner	Rear	Sides
GDS25	24,500	23,000	45°	25 5/8"	23 1/2"	17 1/2"	Ceramic	15"	18"	67.1%	64%	80%	Optional	Yes	Yes	2"	2"	4"

Certified under Canadian and American National Standards.

Figures may vary with individual conditions such as floor plan layout, insulation value/heat loss of the house and geographical location. Measurements to be used as a guide only. Consult your owner's manual for complete and up-to-date installation instructions and proper clearances to combustible materials.

Castlemore™

Shown on pages 8 & 9

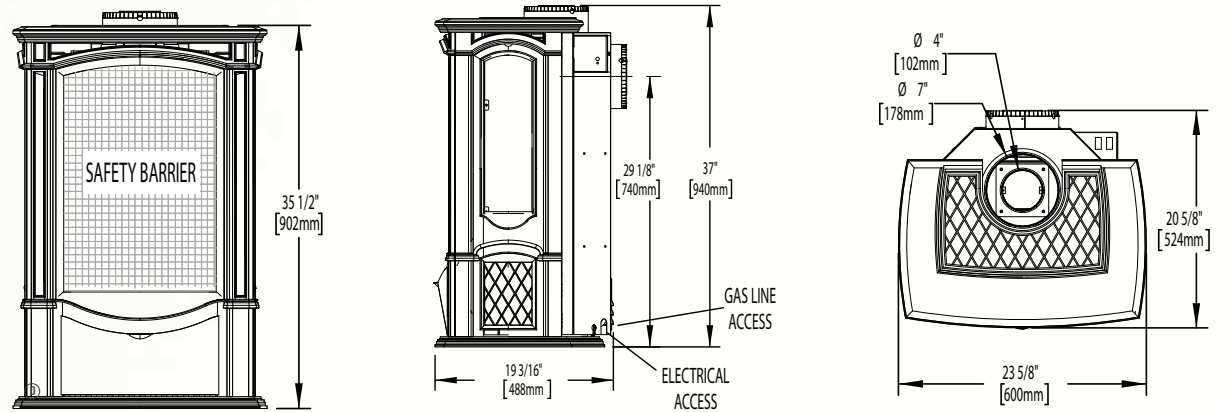

Model	BTU's (Input)		Venting	Height	Front Width	Depth	Glass Type	Glass Size		Efficiencies			Blower Kit	Mobile Home Certified	Electronic Ignition	Minimum Clearances to Combustibles		
	Natural Gas	Propane						Actual	Width	EnerGuide	AFUE	Steady State				Corner	Rear	Sides
GDS26-1	25,000	25,000	Top or Rear	35 1/2"	23 5/8"	19 3/16"	Ceramic	24"	16 5/8"	66.3%	-	82%	Optional	Yes	Yes	2"	5"	2"

Certified under Canadian and American National Standards. This product has a design registration. Wolf Steel Ltd.

Haliburton™

Shown on pages 10 & 11

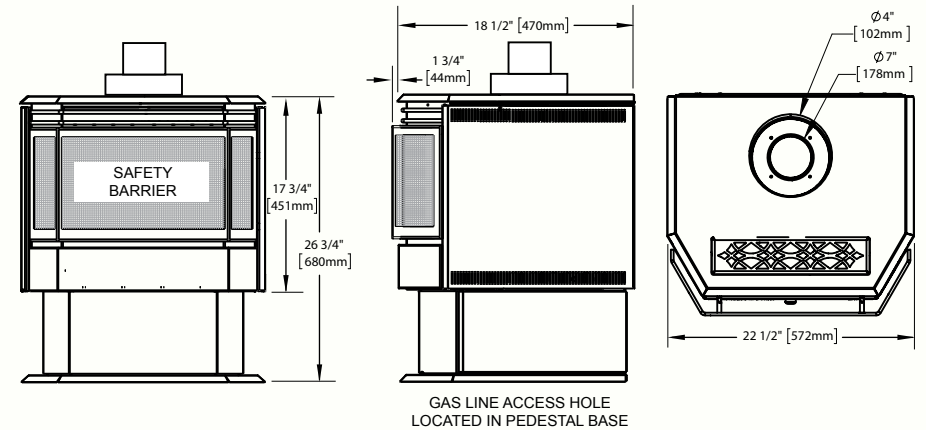

Model	BTU's (Input)		Venting	Height	Front Width	Depth	Glass Type	Glass Size		Efficiencies			Blower	Mobile Home Certified	Electronic Ignition	Minimum Clearances to Combustibles		
	Natural Gas	Propane						Actual	Width	EnerGuide	AFUE	Steady State				Corner	Rear	Sides
GDS28	30,000	26,000	Top	26 3/4"	22 1/2"	18 1/2"	Ceramic	11 3/8"	24 1/2"	63.6%	65%	85%	Standard	Yes	No	1"	2"	7"

Certified under Canadian and American National Standards.

Figures may vary with individual conditions such as floor plan layout, insulation value/heat loss of the house and geographical location. Measurements to be used as a guide only. Consult your owner's manual for complete and up-to-date installation instructions and proper clearances to combustible materials.

Havelock™

Shown on pages 12 & 13

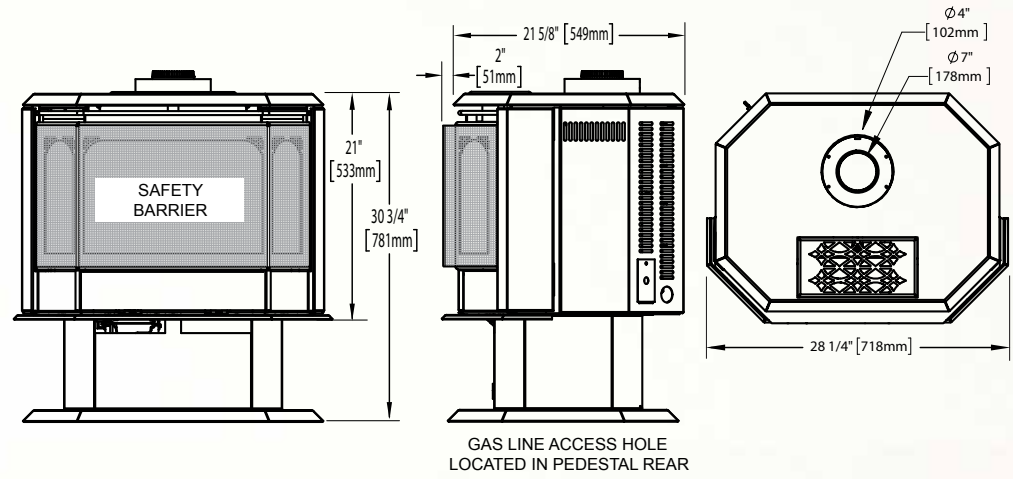

Model	BTU's (Input)		Venting	Height	Front Width	Depth	Glass Type	Glass Size		Efficiencies			Blower	Mobile Home Certified	Electronic Ignition	Minimum Clearances to Combustibles		
	Natural Gas	Propane						Actual	Actual	Actual	Height	Width				EnerGuide	AFUE	Steady State
GDS50	44,000	40,000	Top	30 3/4"	28 1/4"	21 5/8"	Ceramic	12 5/8"	27 5/8"	68.6%	67%	84%	Standard	Yes	No	1"	2"	7"

Certified under Canadian and American National Standards.

Knightsbridge™

Shown on pages 14 & 15

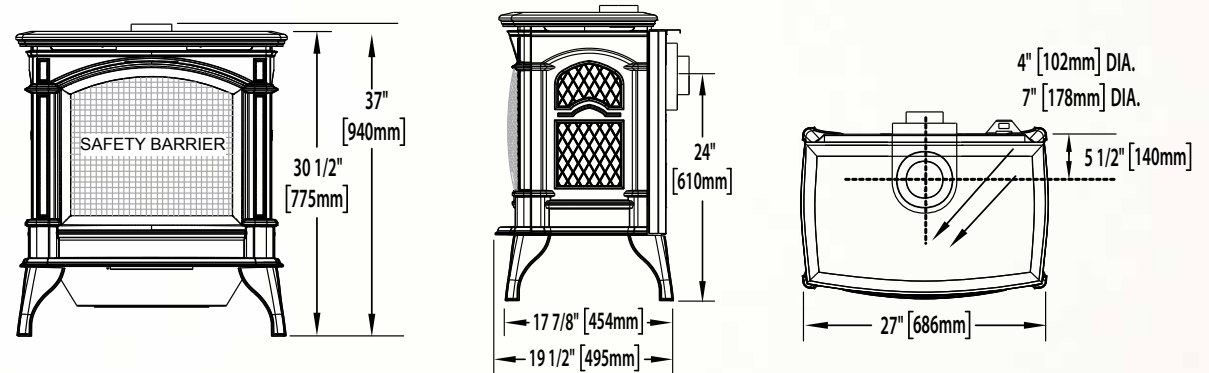

Model	BTU's (Input)		Venting	Height	Front Width	Depth	Glass Type	Glass Size		Efficiencies			Blower Kit	Mobile Home Certified	Electronic Ignition	Minimum Clearances to Combustibles		
	Natural Gas	Propane						Actual	Actual	Actual	Height	Width				EnerGuide	AFUE	Steady State
GDS60	35,000*	31,500*	Top or Rear	30 1/2"	27"	19 1/2"	Ceramic	18 3/4"	21"	59.7%	64%	78%	Optional	Yes	Yes	2"	6"	6"

Certified under Canadian and American National Standards.

*BTU's if top vented. 21,000 BTU's if rear vented.

Figures may vary with individual conditions such as floor plan layout, insulation value/heat loss of the house and geographical location. Measurements to be used as a guide only. Consult your owner's manual for complete and up-to-date installation instructions and proper clearances to combustible materials.

NAPOLEON

CELEBRATING OVER 40 YEARS OF HOME COMFORT PRODUCTS



24 Napoleon Road, Barrie, Ontario, Canada L4M 0G8
 103 Miller Drive, Crittenden, Kentucky, USA 41030
 7200 Trans Canada Highway, Montreal, Quebec, Canada H4T 1A3

Tel: 1-888-721-7253
 napoleon.com

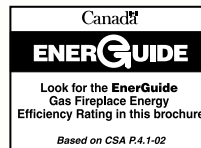

Authorized Dealer

Consult your owner's manual for complete installation instructions and proper clearances to combustible materials. Check all local and national building codes and gas regulations. All specifications are subject to change without prior notice due to on-going product improvements. Products may not be exactly as shown. Flame height and activity is influenced by varying vent configurations and may not appear as shown. Napoleon® is a registered trademark of Wolf Steel Ltd. © Wolf Steel Ltd. EnerGuide - A Canadian efficiency standard based on frequent, short start-up and cool-down cycles. All appliances sold in Canada are subject to this EnerGuide rating system. AFUE - A US efficiency standard (Department of Energy) based on extended on/off cycles, more typical of fireplace usage. Steady State - Reflects the highest possible overall heating efficiency. Product images may vary due to safety barrier regulations coming into effect January 2015.

NAPOLEON

ELEVATION™ AND ALTITUDE™ SERIES GAS FIREPLACES



ELEVATION™ AND ALTITUDE™ SERIES GAS FIREPLACES
napoleon.com



Elevation™ and Altitude™ Gas Fireplaces. Limitless Possibilities.

Napoleon's most versatile series of gas fireplaces, the award winning Elevation™ and Altitude™ provide you with an elegant fire element allowing the flame's radiant glow to enhance any room.

Napoleon's innovative Bluetooth enabled **eFIRE** app can be accessed from your mobile device and used to control everything on your fireplace (flame height, LED ember bed colors, blower and more).

The Elevation™ and Altitude™ Series offer a full viewing experience coupled with a series of authentic-looking logs that make for a truly impressive display of fire. A full range of media and accessory options ensure that each model can be unique to each homeowner. With the addition of heat management there is a reduction of clearance requirements to combustibles, meaning sensitive equipment like televisions, sound bars and artwork can be placed closer to the fireplace enclosure thanks to drastically reduced temperatures above the fireplace.

Elevation™ X Series	4 - 7
Altitude™ X Series	8 - 11
Media Options	12 - 13
Heat Management.....	14 - 15
Specifications & Dimensions	15





Napoleon's Hot Spots Research Study delivers insights on key areas of the home. In particular, how to help you add relaxation, social interaction and functionality to rooms to enhance your memorable moments.

Throughout this brochure we will share some of our insights with you.

For more inspiration visit www.napoleon.com/fireplaces

Elevation™ X Series

Sophisticated Fires

Things don't get more premium than Napoleon's fullview Elevation™ X fireplace. Feature loaded with an electric ember bed with realistic glowing embers that are visible from every angle and an included heat circulating blower, this fireplace has beautiful form and high function. Our infinite design options ensure your favorite spaces flow together. Control this fireplace easily with the included remote or from your favorite mobile device. The optional Dynamic Heat Control™ PLUS System allows heat from the fireplace to be directed to any living area in your home, even if the power goes out. Make the Elevation™ X the stylistic focal point it should be or keep it the traditional and understated crown jewel of your home.

- Glowing ENDLESS EMBERS™ electric ember bed
- Included Remote controls flame modulation, split flow, ember bed lights and blower.
- Heat circulating blower included

Available Sizes:



36"



42"



(Optional)

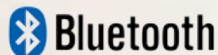

Features



Modulating ENDLESS EMBERS™ electric ember bed glows beneath the log set



Premium Safety Screen included



Remote control included



Various trim options available



eFIRE controller application available free on iTunes and Google Play store

Mobile Device Controlled

Napoleon's eFIRE app will revolutionize the way you use your fireplace. We have cracked the code and present to you the first fireplace to be controlled by Bluetooth® technology, using an intuitive app on your mobile device.

The eFIRE application allows you to create every imaginable color, selecting the one that fits your current mood or your décor with ease. The simple color wheel tool swiftly scrolls through the full color spectrum. Napoleon's eFIRE app controls every function of your fireplace including; on/off, flame height and blower speed for total convenience.

Style & Size Options

Two Models with Various Media Kits, Surrounds and Trims Shown

Trim & Front Options



Premium Trim

Finishing trims available in Black, Charcoal, Copper, and Gunmetal



Zen Front

Available in Black and Charcoal



Beveled Trim



Denali Front

Rubbed Bronze Finish
Available with three iron elements; Satin Nickel, Antique Pewter and Burnished Brass

See more combinations on page 6-7



Whitney Front Black

Available with three iron elements; Satin Nickel, Antique Pewter and Burnished Brass

See more combinations on page 6-7

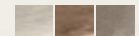

Panel Options



MIRRO-FLAME[™] Porcelain Reflective Radiant Panels



Black Illusion Glass



Newport Brick Panel



Westminster Grey Standard Brick Panel

Also available in Herringbone



Old Town Red Standard Brick Panel

Also available in Herringbone



Glacier Standard

Also available in Herringbone



Antique LedgeStone

Panel options also available in Herringbone



Westminster Grey
Herringbone



Old Town Red
Herringbone

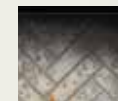

Glacier
Herringbone

Log Set Options



Birch Log Set



Driftwood Log Set



Split Oak Log Set

Elevation™ X36



EX36 With Denali Front and Nickel Accents,
Porcelain Reflective Panels and Split Oak log set



EX36 With Copper Finishing Trim, Newport panels
and Driftwood log set



EX36 With Denali Front and Pewter Accents,
Westminister Grey Herringbone panels and Birch log set



EX36 With Whitney Front and Satin Nickel Accents,
Old Town Red Standard brick panels and Driftwood log set

EX36

Up to 37,000 BTU's

Viewing Area: 36" w x 33 1/8" h

Natural Gas or Propane



EX42 With Whitney Front and Pewter Accents,
Porcelain reflective panels and Driftwood log set



EX42 With Charcoal Finishing Trim, Westminster
Grey Herringbone Panels and Driftwood log set



EX42 With Whitney Front and Burnished Brass accents,
Porcelain Reflective Panels and Birch log set



EX42 With Denali Front and Satin Nickel Accents,
Porcelain Reflective Panels and Driftwood log set

EX42

Up to 45,000 BTU's

Viewing Area: 42" w x 37 1/8" h

Natural Gas or Propane

Elevation™ X 42



Altitude™ X Series

Sophisticated Fires

Designed to provide the ideal aspect ratio for an aesthetically pleasing view, the Altitude™ X fireplace is a fullview fireplace that you can truly make your own. The clean-faced, minimalist design and full-width firebox are highlighted by the included NIGHT LIGHT™ which illuminates the firebox and logs even when the fireplace is off. Set the tone with a selection of premium logs. Operate the luxurious Altitude™ X from your comfy spot using your favorite mobile device and the eFIRE Remote App. The only question about your new Altitude™ X fireplace is which styles will you choose to make this fireplace truly yours?

- Full view, clean faced firebox
- Remote control included, with eFIRE app
- NIGHT LIGHT™ included

Available Sizes:



36"



42"



Features



NIGHT LIGHT™ included



Premium Safety Screen included



Remote control included



eFIRE controller application available free on iTunes and Google Play store

Mobile Device Controlled

Napoleon's eFIRE app will revolutionize the way you use your fireplace. We have cracked the code and present to you the first fireplace to be controlled by *Bluetooth*™ technology, using an intuitive app on your mobile device.

The eFIRE application allows you to create every imaginable color, selecting the one that fits your current mood or your décor with ease. The simple color wheel tool swiftly scrolls through the full color spectrum. Napoleon's eFIRE app controls every function of your fireplace including; on/off, flame height and blower speed for total convenience.

Style & Size Options

Two Models with Various Media Kits, Surrounds and Trims Shown

Trim & Front Options



Premium Trim

Finishing trims available in Black, Charcoal, Copper, and Gunmetal



Beveled Trim Black



Zen Front

Available in Black and Charcoal



Denali Front

Rubbed Bronze Finish

Accent Trims are available in Satin Nickel, Antique Pewter and Burnished Brass

See page 10-11 to see full view

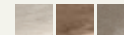

Whitney Front Black

Available accent trims in three colours; Satin Nickel, Antique Pewter and Burnished Brass

See page 10-11 to see full view

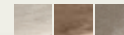

Panel Options



MIRRO-FLAME™ Porcelain Reflective Radiant Panels



Black Illusion Glass



Newport Standard



Old Town Red Standard

Also available in Herringbone



Westminster Grey Standard

Also available in Herringbone

Panel options also available
in Herringbone



Old Town Red
Herringbone



Westminster Grey
Herringbone

Log Set Options



Driftwood Log Set



Split Oak Log Set



Maple Log Set



Birch Log Set

Altitude™ X 36



AX36 With Denali Front, Newport Brick Panels and Split Oak Log Set



AX36 With Whitney Front, Pewter Accents, Porcelain Reflective Panels and Birch Log Set



AX36 With Denali Front, Pewter Accents, Westminster Grey Standard and Maple Log Set



AX36 With Denali Front, Satin Nickel Accents, Porcelain Reflective Panels and Birch Log Set

AX36

Up to 36,500 BTU's

Viewing Area: 35" 1/4 w x 33 1/8" h

Natural Gas or Propane



AX42 With Gunmetal Finishing Trim, Westminister Grey Herringbone and Split Oak Log Set



AX42 With Black Zen Trim, Newport Brick Panels and Split Oak Log Set



AX42 With Whitney Front, Burnished Brass Accents, Porcelain Reflective Panels and Birch Log Set



AX42 With Charcoal Finishing Trim, Old Town Red Standard Brick Panels and Split Oak Log Set

AX42

Up to 38,000 BTU's

Viewing Area: 42 1/4" w x 36 1/8" h

Natural Gas or Propane



Altitude™ X 42

Log Set Gallery



Split Oak Log set



Driftwood Log set



Maple Log set
Available with Altitude Series only



Birch Log set

Media Gallery

MIRRO-FLAME™ Porcelain Reflective Radiant Panels



Modulating ENDLESS EMBERS™ electric ember bed glows beneath the log set (Available on Elevation Series only)



MIRRO-FLAME™ Porcelain Reflective Radiant Panels



Multiple Brick Kit Options



Trim, Front and Accent options

Heat Management

Napoleon prides itself on innovation and creating a comfortable environment for the room you live in by getting the most enjoyment possible out of that room – that means creating heat management solutions. Heat Management allows you to install your television, art, and electronics closer to your fireplace; and can even move the heat to another room – or even outside!

Universal Heat Management - UHM

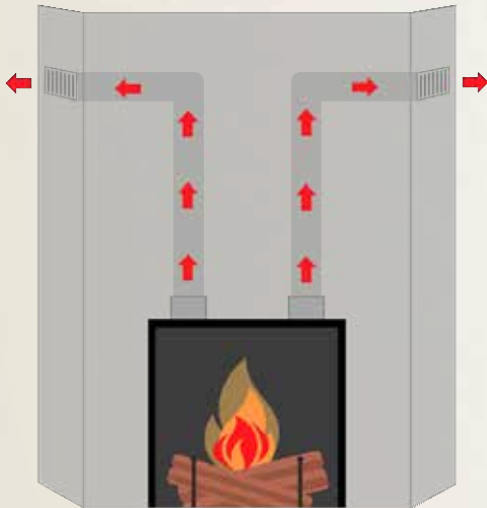

A convection heat source with no blower. Two collars, tubes and up to two grills directs heat transfer into the room while also drastically reducing heat around the fireplace front and inside the enclosure. This allows a smaller enclosure to be built and a lower enclosure height. The UHM system also allows a TV to be recessed above the fireplace and in closer proximity. Provides even heat around the room without a blower and with no noise.

* Available with Altitude[™] X Series

Hot Air Distribution Kit - LHAD

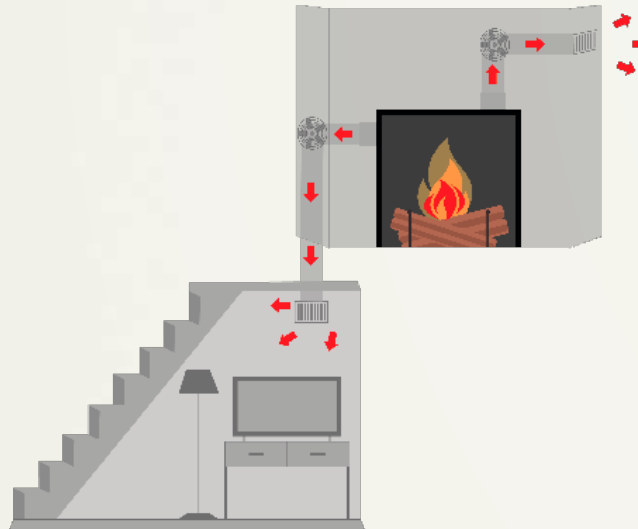

A moderate heat source that has a blower and directs heat from the side of unit and not the top. The LHAD system increases heat transfer into the room and farther into the room by around 5' - 10'. The LHAD system allows heat transfer to another room or into lower level like a basement. You are also able to direct the heat with placement of the LHADs. A blower creates power which allows controllability. Including being able to control from another room.

* Available with Altitude[™] X and Elevation[™] X Series



The Dynamic Heat Control[™] Plus system takes heat management to the next level. The DHC Plus[™] System is designed for advanced heat management even in the event of a power outage by directing warm air to any living space where heat is needed within the home, or even exhausting the heat outside if it is not required.

* Available with Elevation[™] X Series

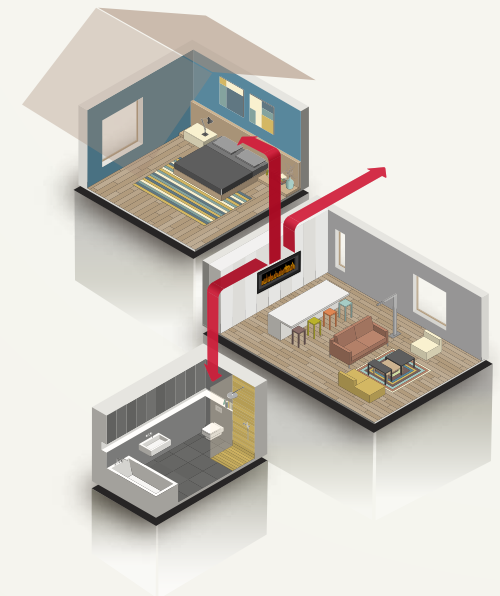

FOCUSED ON VERSATILITY

Engineered to optimize air flow both through the appliance and enclosure to reduce surface temperatures, this system allows for more versatile installation opportunities allowing for increased comfort. See below for examples of the Dynamic Heat Control[™] Fireplace installations options for virtually limitless possibilities.

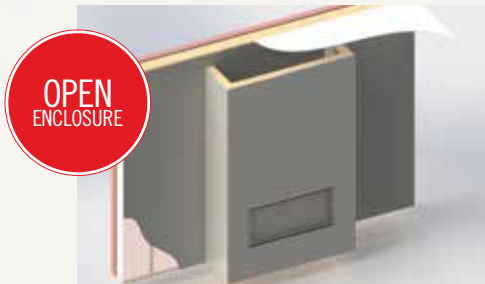

Stopping shy of the ceiling at the top, allows rising hot air to escape freely from the top of the enclosure and into the room.



Uses an air outlet opening that will be built into the front of the constructed enclosure, at the top, centered above the appliance.



Stopping shy of the ceiling at the top, allows rising hot air to escape freely from the top of the enclosure and into the room.



This style of enclosure includes an air outlet opening that will be built into the rear of the constructed enclosure, at the top, centered above the appliance.

Specifications and Dimensions

Altitude[™] Series

Product Name	Model	BTU'S (Input)	Top Vent	Height		Front Width		Depth		Glass Type	Firebox Viewing Area		Efficiency	Blower
				Actual	Framing	Actual	Framing	Actual	Framing		Height	Width		
Altitude [™] X 36	AX36	36,500	5" x 8"	42 7/16"	43 5/8"	35 1/4"	35 3/4"	18 3/4"	19"	Ceramic	33 1/8"	35 1/4"	41.4%	included
Altitude [™] X 42	AX42	38,000	5" x 8"	45 7/16"	46 5/8"	42 1/4"	42 3/4"	18 5/8"	19"	Ceramic	36 1/8"	42 1/4"	47.7%	included

Certified under Canadian and American National Standards
 Figures may vary with individual conditions such as floor plan layout, insulation value/heat loss of the house and geographical location.

Elevation[™] Series

Product Name	Model	BTU'S (Input)	Top Vent	Height		Front Width		Depth		Glass Type	Firebox Viewing Area		Efficiency	Blower
				Actual	Framing	Actual	Framing	Actual	Framing		Height	Width		
Elevation [™] X 36	EX36	37,000	5" x 8"	44"	43 3/4"	38 3/4"	39 3/4"	22"	22 1/4"	Ceramic	33 1/8"	36"	53.8%	included
Elevation [™] X 42	EX42	45,000	5" x 8"	48"	47 3/4"	44 3/4"	45 3/4"	22"	22 1/4"	Ceramic	37 1/8"	42"	58.3%	included

Certified under Canadian and American National Standards
 Figures may vary with individual conditions such as floor plan layout, insulation value/heat loss of the house and geographical location.

NAPOLEON

CELEBRATING OVER 40 YEARS OF HOME COMFORT PRODUCTS



napoleon.com

24 Napoleon Road, Barrie, Ontario L4M 0G8
 103 Miller Drive, Crittenden, Kentucky, USA 41030
 7200 Trans Canada Highway, Montreal, Quebec H4T 1A3

PHONE: 1-888-721-7253

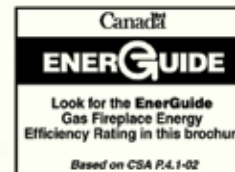

Authorized Dealer

Consult your owner's manual for complete installation instructions and proper clearances to combustible materials. Check all local and national building codes and gas regulations. All specifications are subject to change without prior notice due to on-going product improvements. Products may not be exactly as shown. Flame height and activity is influenced by varying vent configurations and may not appear as shown. Napoleon is a registered trademark of Wolf Steel Group Inc. EnerGuide - A Canadian efficiency standard based on frequent, short start-up and cool-down cycles. All appliances sold in Canada are subject to this EnerGuide rating system. AFUE- A US efficiency standard (Department of Energy) based on extended on/off cycles, more typical of fireplace usage. Steady State - Reflects the highest possible overall heating efficiency.

NAPOLEON



ASCENT™ AND ACIES™ LINEAR SERIES GAS FIREPLACES
napoleonfireplaces.com



Ascent™ and Acies™ Linear Series Gas Fireplaces. Distinct Options.

Napoleon's Ascent™ Linear and Acies™ series boasts beauty and performance. These linear gas fireplaces can match any room décor or can be stylized to be a focal point in your room.

Their linear look is specifically designed to provide you with a sophisticated fire element that is perfect for both new building and renovation projects. They provide a complete luxurious experience delivered courtesy of the Divinity™ flame pattern. With the Acies™ Series you can double the enjoyment and double the statement you make in your home with the See Thru model.

Choose from a broad selection of designer options including surrounds, colored glass, river rocks, driftwood logs, media enhancement Kits and more!

Ascent™ Linear Series	4 - 9
Acies™ Series	10 - 15
Ascent™ Linear Series Features & Specifications.....	16 - 17
Acies™ Series Features & Specifications.....	18 - 19



Ascent™ Linear Series

Radiant Heat & Flame Innovation

The Napoleon Ascent™ Linear Series are perfect for homeowners, remodelers and custom builders. The Ascent™ Linear 36 and Ascent™ Linear 46 come standard with an exclusive Topaz CRYSTALINE™ ember bed that can be switched out to a completely new look and feel with the Shore Fire, Beach Fire and Mineral Rock Kits which include a variety of rocks, sand, logs and vermiculite.

Available Sizes:



36"

46"



Bluetooth®



Features



Optional Remote Controls



Topaz CRYSTALINE™ Ember Bed (included)



MIRRO-FLAME™ Porcelain Reflective Radiant Panels (Optional)



Optional Premium Blower



eFIRE controller application available free on iTunes and Google Play store

Mobile Device Controlled

Napoleon's eFIRE app will revolutionize the way you use your fireplace. We have cracked the code and present to you the first fireplace to be controlled by *Bluetooth*® technology, using an intuitive app on your mobile device. Napoleon's eFIRE app controls every function of your fireplace including; on/off, flame height and blower speed for total convenience.

(Optional for the Ascent™ Linear Series)

Style & Size Options

Various Models, Media Kits, Surrounds and Trims Shown



Black Standard Safety Barrier

Shown on Ascent™ Linear 36 with Shore Fire Media Kit



Black Standard Safety Barrier

Shown on Ascent™ Linear 46 with Shore and Beach Fire Kits combined



Black Standard Safety Barrier

Shown on Ascent™ Linear 36 with Topaz Glass Embers (included)



Classic Black Surround

Shown on Ascent™ Linear 36 with Beach Fire and Mineral Rock Kits combined on Clear Glass Beads



Classic Black Surround

Shown on Ascent™ Linear 46 with Mineral Rock Kit on Black Glass Embers



Classic Black Surround

Shown on Ascent™ Linear 36 with Shore Fire Kit



Premium Brushed Stainless Steel Surround

Shown on Ascent™ Linear 36 with Beach Fire Kit on Amber Glass Embers



Premium Brushed Stainless Steel Surround

Shown on Ascent™ Linear 46 with Clear Glass Beads



Premium Brushed Stainless Steel Surround

Shown on Ascent™ Linear 36 with Mineral Rock Kit on Topaz Glass Embers

Media Options

Mineral Rock Kits on Topaz Glass Embers



Media Options

Beach Fire and Shore Fire Kits Combined



Beach Fire Kit



Shore Fire Kit (sand included)



Beach Fire, Shore Fire and Mineral Rock Kits combined



Topaz Glass Embers



Clear Glass Beads



Beach Fire Kit on Topaz Glass Embers



MIRRO-FLAME[®] Porcelain Reflective Radiant Panels



AMBIENT-GLOW Ember enhancing Metal Fibers



Blue Glass Embers



Amber Glass Embers



Black Glass Embers



Red Glass Embers



Topaz Glass Embers (Included)



Clear Glass Embers



Blue Glass Beads



Amber Glass Beads



Black Glass Beads



Red Glass Beads

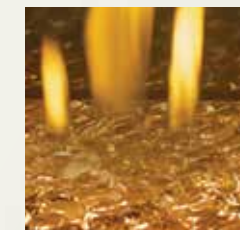

Topaz Glass Beads



Clear Glass Beads

Ascent™ Linear 36



Ascent™ Linear 36 - Black Standard Safety Barrier



Ascent™ Linear 36 - Premium Brushed Stainless Steel Surround



Ascent™ Linear 36 - Classic Black Surround

BL36-1

Up to 17,500 BTU's

Viewing Area: 18 13/16" h x 31 9/16" w

For more detailed specifications on this unit, see page 16

Ascent™ Linear 46

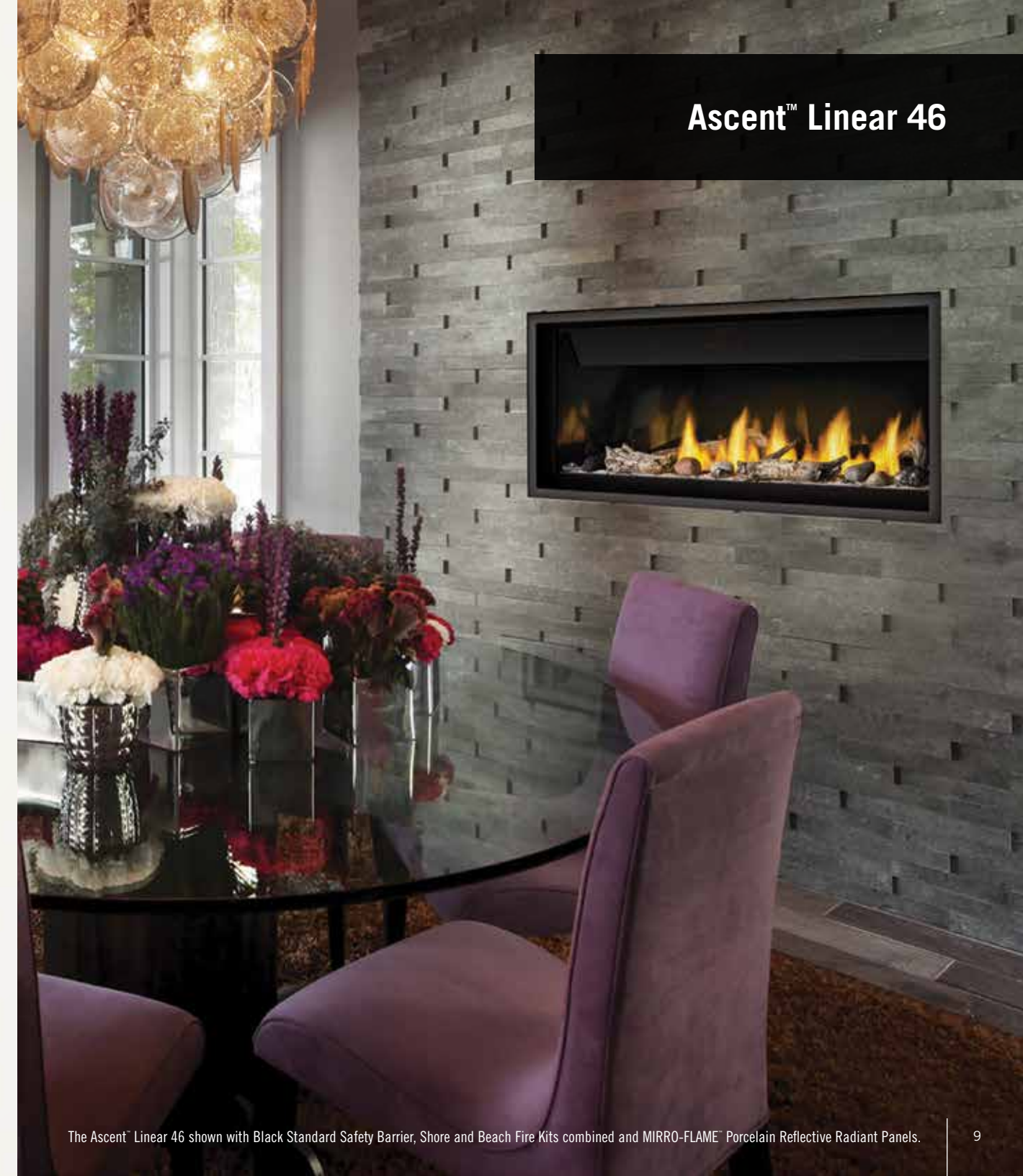

Ascent™ Linear 46 - Black Standard Safety Barrier



Ascent™ Linear 46 - Premium Brushed Stainless Steel Surround



Ascent™ Linear 46 - Classic Black Surround

BL46

Up to 24,000 BTU's

Viewing Area: 18 13/16" h x 42 1/2" w

For more detailed specifications on this unit, see page 16

Acies™ Series

Breathtaking Ambiance

With a sleek linear design and a multitude of designer options, Napoleon's Acies™ series gas fireplaces provide a complete luxurious experience delivered courtesy of their new Divinity™ flame pattern. Available as a single sided or a two sided See Thru model, the radiant glow is enjoyed through the CRYSTALINE™ ember bed with the option of adding Beach Fire, Shore Fire, Mineral Rock media enhancement kits and more!

Available Sizes:

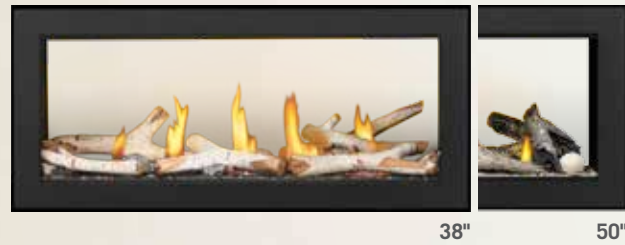

Features



Optional Remote Controls



Topaz CRYSTALINE™ Ember Bed (included)



MIRRO-FLAME™ Porcelain Reflective Radiant Panels (Optional)



eFIRE controller application available free on iTunes and Google Play store

Mobile Device Controlled

Napoleon's eFIRE app will revolutionize the way you use your fireplace. We have cracked the code and present to you the first fireplace to be controlled by *Bluetooth*® technology, using an intuitive app on your mobile device. Napoleon's eFIRE app controls every function of your fireplace including; on/off, flame height and blower speed for total convenience.

(Optional for the Acies™ Linear Series)

Style & Size Options

Various Models, Media Kits, Surrounds and Trims Shown



Black Standard Safety Barrier

Shown on Single Sided Acies™ 38 with Topaz Glass Embers

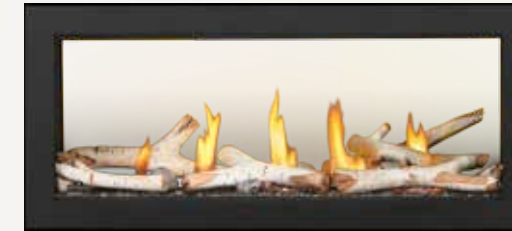

Black Standard Safety Barrier

Shown on See Thru Acies™ 38 with Birch Logs on Topaz Glass Embers



Black Standard Safety Barrier

Shown on Single Sided Acies™ 50 with Shore and Beach Fire Kits combined



Brushed Stainless Steel Surround and 1" Finishing Trim

Shown on See Thru Acies™ 38 with Topaz Glass Embers



Classic Black Surround and 1" Finishing Trim

Shown on Single Sided Acies™ 38 with Topaz Glass Embers



Brushed Stainless Steel Surround

Shown on See Thru Acies™ 50 with Topaz Glass Embers



Black Standard Safety Barrier

Shown on Single Sided Acies™ 38 with Birch Logs on Topaz Glass Embers



Brushed Stainless Steel Surround

Shown on See Thru Acies™ 38 with Beach and Shore Fire Kits combined



Classic Black Surround

Shown on Single Sided Acies™ 50 with Mineral Rock Kit on Topaz Glass Embers

Media Options

Premium Birch Log Kit with Mineral Rock Kit on Topaz Glass Embers



Media Options

Nickel Stix on Topaz Glass Embers



Beach Fire and Shore Fire Kits Combined



Shore Fire Kit (sand included)



Mineral Rock Kit



Topaz Glass Embers



Clear Glass Beads



Beach Fire Kit on Topaz Glass Embers



MIRRO-FLAME Porcelain Reflective Radiant Panels



AMBIENT-GLOW Ember Enhancing Metal Fibers



Blue Glass Embers



Amber Glass Embers



Black Glass Embers



Red Glass Embers



Topaz Glass Embers (Included)



Clear Glass Embers



Blue Glass Beads



Amber Glass Beads



Black Glass Beads



Red Glass Beads

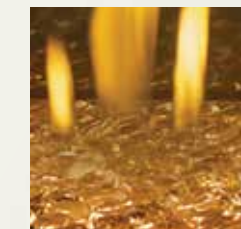

Topaz Glass Beads



Clear Glass Beads

Acies™ 38

Single-Sided & See Thru Models

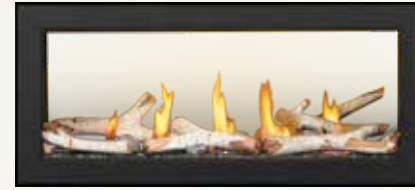

Acies™ 38 - Black Standard Safety Barrier



Acies™ 38 - Black Standard Safety Barrier



Acies™ 38 - Brushed Stainless Steel Surround



Acies™ 38 - Classic Black Surround and 1" Finishing Trim

L38N / L38N2

Up to 24,000 BTU's

Viewing Area: 18 13/16" h x 40 3/4" w

For more detailed specifications on this unit, see page 18



Acies™ 50 - Black Standard Safety Barrier



Acies™ 50 - Black Standard Safety Barrier



Acies™ 50 - Brushed Stainless Steel Surround



Acies™ 50 - Classic Black Surround

L50N / L50N2

Up to 30,000 BTU's

Viewing Area: 18 13/16" h x 52 3/4" w

For more detailed specifications on this unit, see page 18

Acies™ 50

Single-Sided & See Thru Models



The See Thru Acies™ 50 shown with Classic Black Surround, Beach and Shore Fire Kits combined.

Ascent™ Linear Series

Product Features

- Clean face design with high quality safety barrier included
- Available in Natural Gas and Propane
- SIT Proflame II system (remote control not included)
- Optimized burner performance (for all vent and fuel configurations)
- Includes **CRYSTALINE™** topaz glass ember bed
- **Divinity™** flame pattern provides heightened peaks and valleys
- Non-combustible material included, no steel framing required
- Easy access air control for fast and precise air shutter adjustments
- Fuel saving electronic ignition with battery back-up

- Electronic Ignition including High/Low Flame adjustment
- Optional **MIRRO-FLAME™** Porcelain Reflective Radiant Panels available
- Low profile optional surrounds available in black and stainless steel
- Optional media includes: Mineral Rock Kit, Shore Fire Kit and Beach Fire Kits, Glass Embers and Glass Beads in various colors!
- Optional blower Kits available
- **eFIRE** App allows you to customize your enjoyment with the convenience of your mobile device (optional)
- Manual high/low flame adjustment



Ascent™ Linear Series

Dimensions & Specifications

BL36-1

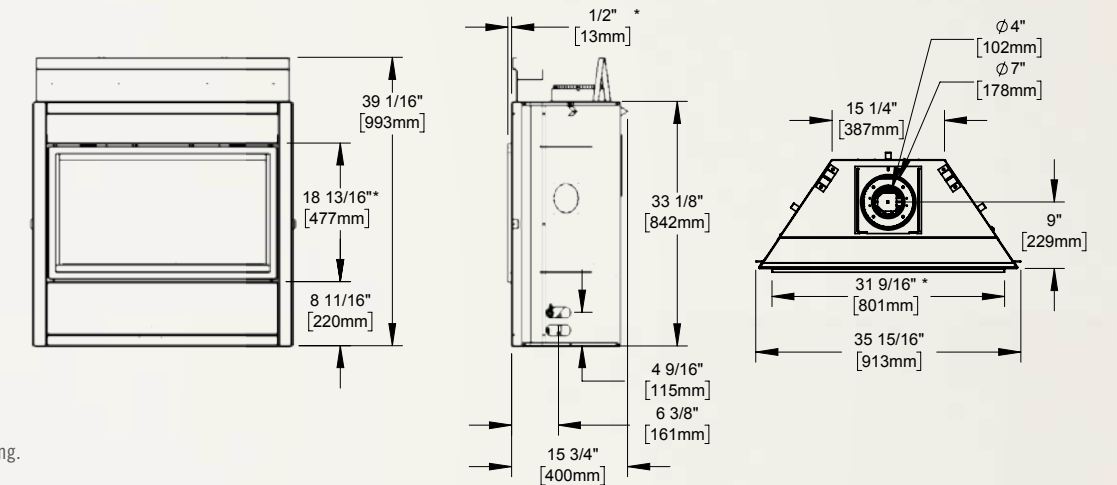

*Finishing flange depth (The finishing flange defines the perimeter of the fireplace opening. Framing or finishing materials must **NEVER** encroach inside the finishing flange).

Product Code	BTU's (Input)	Venting 4" / 7"	Height		Width		Depth		Viewing Area		Efficiency P4
			Actual	Framing	Actual	Framing	Actual	Framing	Height	Width	
BL36-1	17,500	Top	39 1/16"	39 3/8"	35 15/16"	36 1/2"	15 11/16"	16"	18 13/16"	31 9/16"	51.7%

BL46

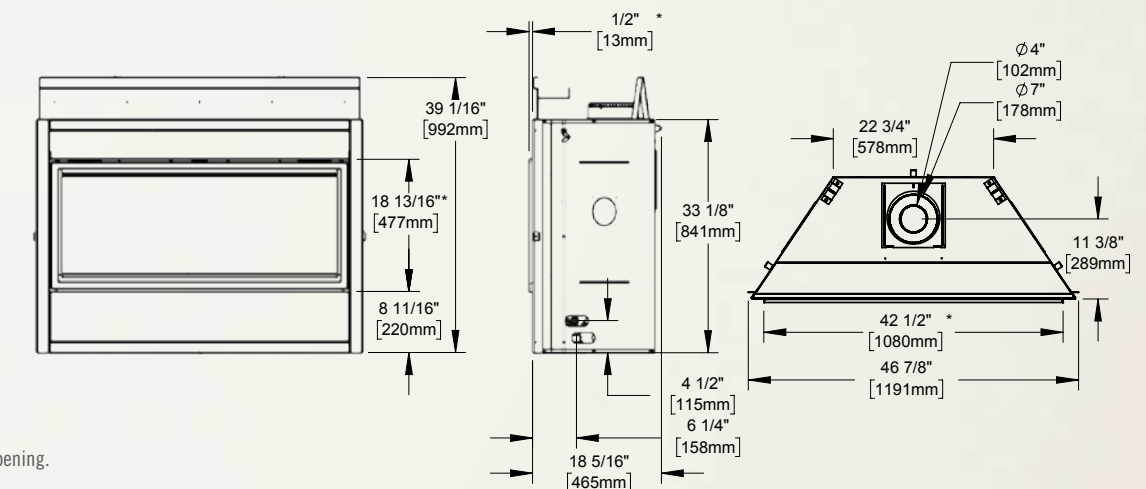

*Finishing flange depth (The finishing flange defines the perimeter of the fireplace opening. Framing or finishing materials must **NEVER** encroach inside the finishing flange).

Product Code	BTU's (Input)	Venting 4" / 7"	Height		Width		Depth		Viewing Area		Efficiency P4
			Actual	Framing	Actual	Framing	Actual	Framing	Height	Width	
BL46	24,000	Top	39 1/16"	39 3/8"	46 7/8"	47 3/8"	18 5/16"	18 9/16"	18 13/16"	42 1/2"	50.3%

Acies™ Series

Product Features

- Black Standard Safety Barrier included
- Available in Natural Gas and Propane
- New Premium Birch Log Kit available
- SIT Proflame II system (remote not included)
- Includes **CRYSTALLINE™** topaz glass ember bed
- **Divinity™** flame pattern provides heightened peaks and valleys
- Easy access air control for fast and precise air shutter adjustments
- Fuel saving electronic ignition with battery back-up

- Electronic Ignition
- Manual High/Low Flame adjustment
- Optional **MIRRO-FLAME™** Porcelain Reflective Radiant Panels available
- Low profile optional surrounds and 1" Finishing Trims available in black and stainless steel
- Optional media includes: Nickel Stix, Mineral Rock Kit, Shore Fire Kit and Beach Fire Kits, Glass Embers and Glass Beads in various colors!
- **eFIRE** App allows you to customize your enjoyment at the convenience of your mobile device (optional)

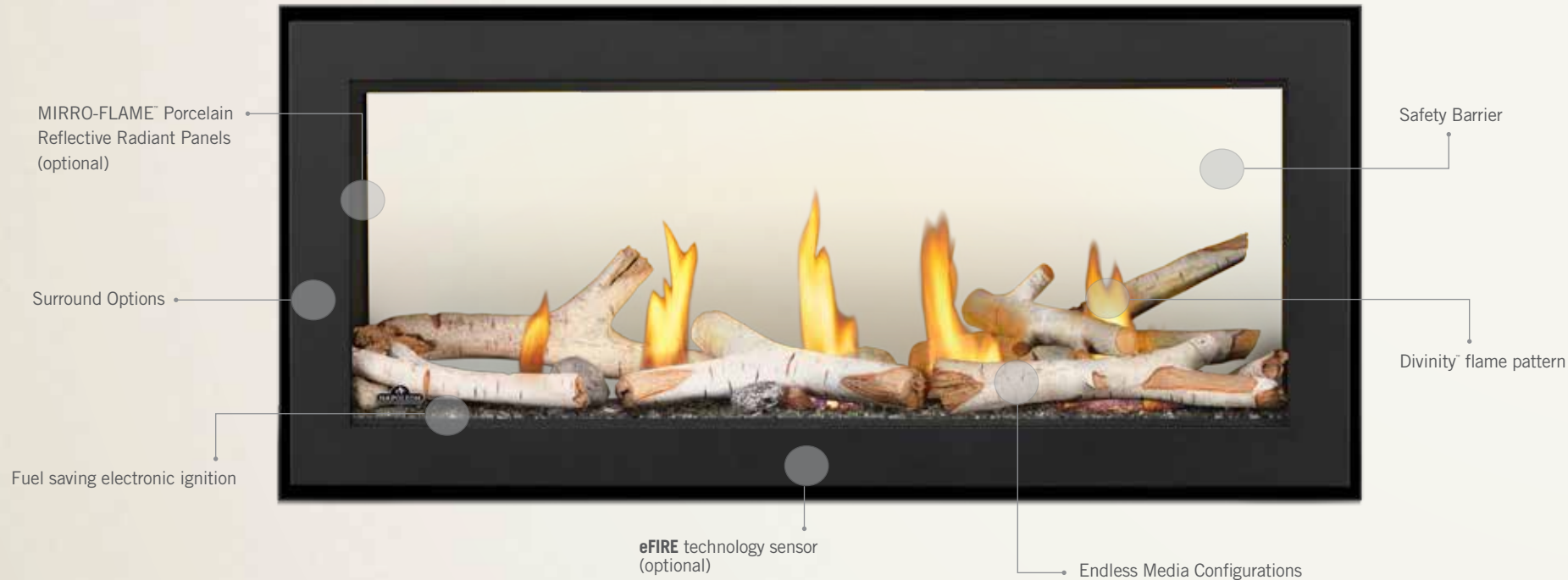

Acies™ Series

Dimensions & Specifications

Single Sided Model

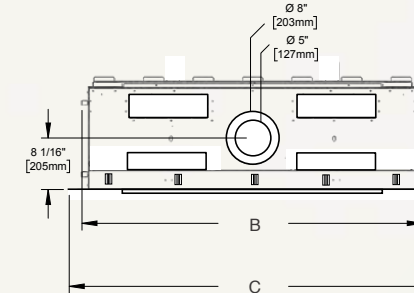
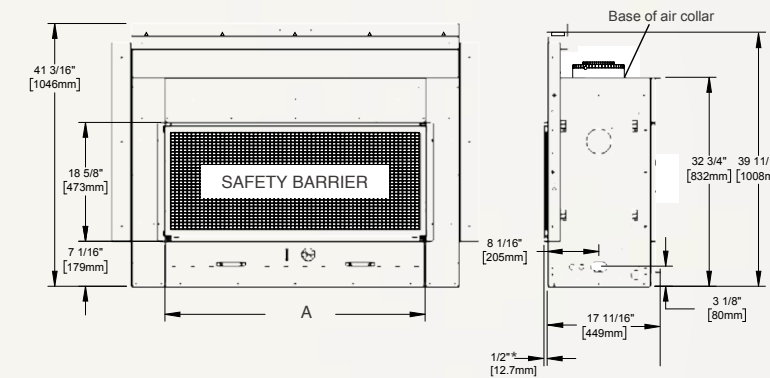

	CL38	CL50
A	40 3/4" (1035mm)	52 3/4" (1340mm)
B	53 5/16" (1354mm)	65 5/16" (1659mm)
C	57 5/16" (1456mm)	69 5/16" (1761mm)

*Finishing flange depth (The finishing flange defines the perimeter of the fireplace opening. Framing or finishing materials must **NEVER** encroach inside the finishing flange).

See Thru Model

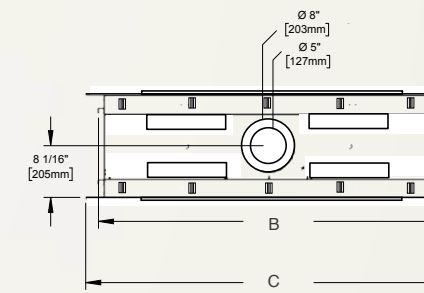
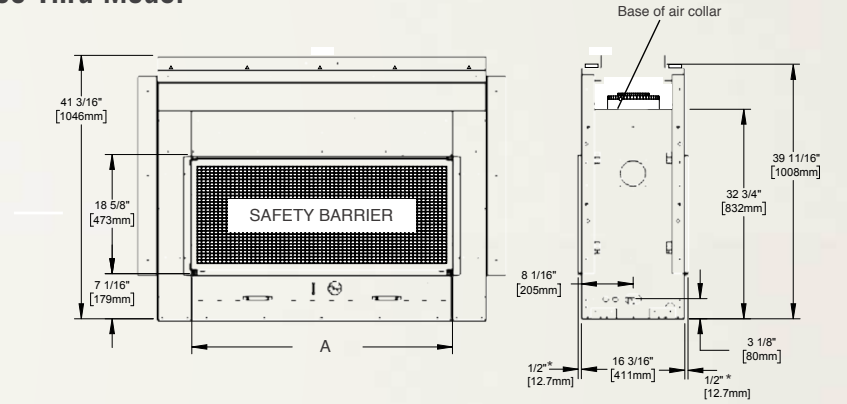

	CL38	CL50
A	40 3/4" (1035mm)	52 3/4" (1340mm)
B	53 5/16" (1354mm)	65 5/16" (1659mm)
C	57 5/16" (1456mm)	69 5/16" (1761mm)

*Finishing flange depth (The finishing flange defines the perimeter of the fireplace opening. Framing or finishing materials must **NEVER** encroach inside the finishing flange).

Product Code	BTU's (Input)	Venting 5" / 8"	Height		Width		Depth		Glass Size		Efficiency P4
			Actual	Framing	Actual	Framing	Actual	Framing	Height	Width	
L38N (Single Sided)	24,000	Top	39 11/16"	39 15/16"	53 5/16"	53 13/16"	17 11/16"	18"	18 5/8"	40 3/4"	38.5%
L38N2 (See Thru)	24,000	Top	39 11/16"	39 15/16"	53 5/16"	53 13/16"	16 3/16"	16 3/16"	18 5/8"	40 3/4"	38.5%
L50N (Single Sided)	30,000	Top	39 11/16"	39 15/16"	65 5/16"	65 13/16"	17 11/16"	18"	18 5/8"	52 3/4"	45.3%
L50N2 (See Thru)	30,000	Top	39 11/16"	39 15/16"	65 5/16"	65 13/16"	16 3/16"	16 3/16"	18 5/8"	52 3/4"	45.3%



NAPOLEON - CELEBRATING OVER 40 YEARS OF HOME COMFORT PRODUCTS



24 Napoleon Road, Barrie, Ontario, Canada L4M 0G8
103 Miller Drive, Crittenden, Kentucky, USA 41030
7200 Trans Canada Highway, Montreal, Quebec, Canada H4T 1A3

Tel: 1-866-820-8686
napoleonfireplaces.com

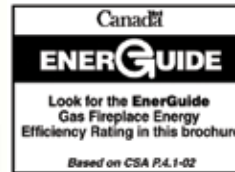

Authorized Dealer

Consult your owner's manual for complete installation instructions and proper clearances to combustible materials. Check all local and national building codes and gas regulations. All specifications are subject to change without prior notice due to on-going product improvements. Products may not be exactly as shown. Flame height and activity is influenced by varying vent configurations and may not appear as shown. Napoleon® is a registered trademark of Wolf Steel Ltd. © Wolf Steel Ltd. EnerGuide - A Canadian efficiency standard based on frequent, short start-up and cool-down cycles. All appliances sold in Canada are subject to this EnerGuide rating system. AFUE - A US efficiency standard (Department of Energy) based on extended on/off cycles, more typical of fireplace usage. Steady State - Reflects the highest possible overall heating efficiency.

NAPOLEON



DISTINCT DIRECT VENT FIREPLACES
napoleonfireplaces.com



Find your happy (fire)place.

Throughout the ages, people have gathered around fires to share in life's greatest joys. There's just something about the glow of flickering flames that makes special moments feel even warmer.

A Napoleon fireplace is uniquely designed to brighten the vibe of any room in your house. Napoleon has an incredible range of designer options to fit any vision.

A fire not only raises the warmth and ambiance of a room, it can raise the value of your home. A fireplace offers some of the highest returns of any remodeling project. And that should make you feel good all over.

And so you can keep enjoying that positive glow for years and years and years to come, every Napoleon fireplace is backed by the President's Limited Lifetime Warranty.

Torch™ - GT8	4 - 5
Vittoria™ - GD19	6 - 7
Park Avenue™ - GD82T-PAE	8 - 9
Tureen™ - GD82T-TE	10 - 11
Plazmafire™ 31 - WHD31	12 - 13
Plazmafire™ 48 - WHD48	14 - 15
Crystallo™ - BGD36CFG	16 - 17
Grandville™ 36 CF - BGD36CF	18 - 19
Napoleon's Outstanding Features	20 - 21
Detailed Specifications & Line Drawings	22 - 25



We are proud to be recognized as one of Canada's Best Managed Companies and are dedicated to providing quality, home comfort products for over 40 years and counting.

Cover Photo - The Plazmafire 48 shown with Black Surround.

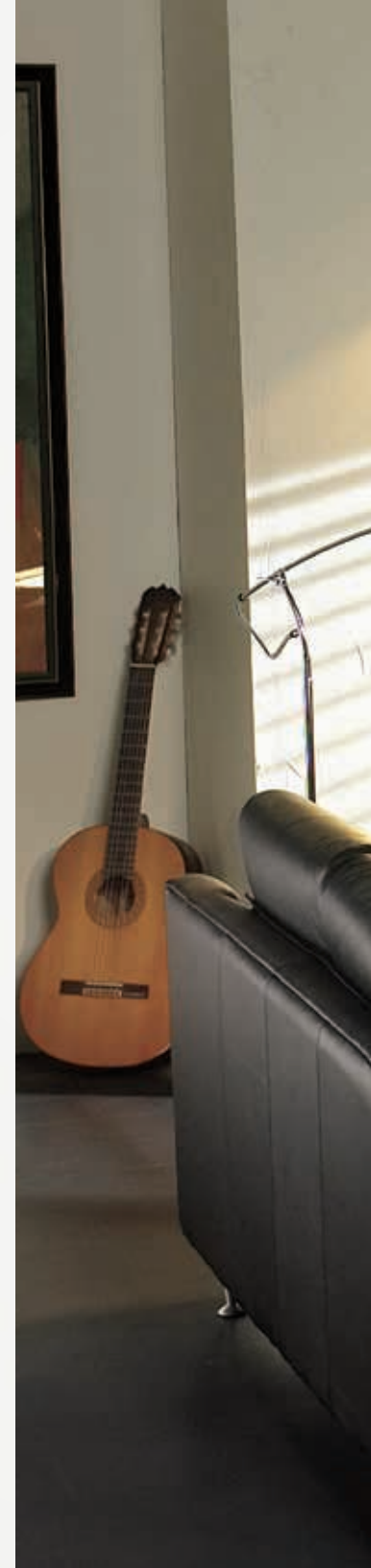



Napoleon's Hot Spots Research Study delivers insights on key areas of the home. In particular, how to help you add relaxation, social interaction and functionality to rooms to enhance your memorable moments.

Throughout this brochure we will share some of our insights with you. For more inspiration visit napoleonfireplaces.com/inspiration



The Park Avenue™ shown with Rectangular Black Surround and Herringbone Sandstone Brick Panels.

Torch®

Modern Simplicity

Napoleon's Torch® is an ultra modern fireplace with a slim design featuring a reflective, prism shaped firebox. The simplicity of the single luminous flame glows with artistic character. The perfect accent for bedrooms, bathrooms, kitchens, entranceways, hallways, offices, bars, lounges and waiting rooms. Versatile installations make the Torch® ideal for new construction and renovation projects, especially where space is limited.

Options & Accessories



Adjustable Mounting Cabinets, Two Finish Options



LED Accent Light Kit
Four Lights Included



Push Button Auto Ignition

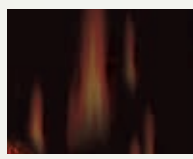

MIRRO-FLAME® Porcelain Reflective Radiant Panels (included)



Brushed Stainless Steel Surround

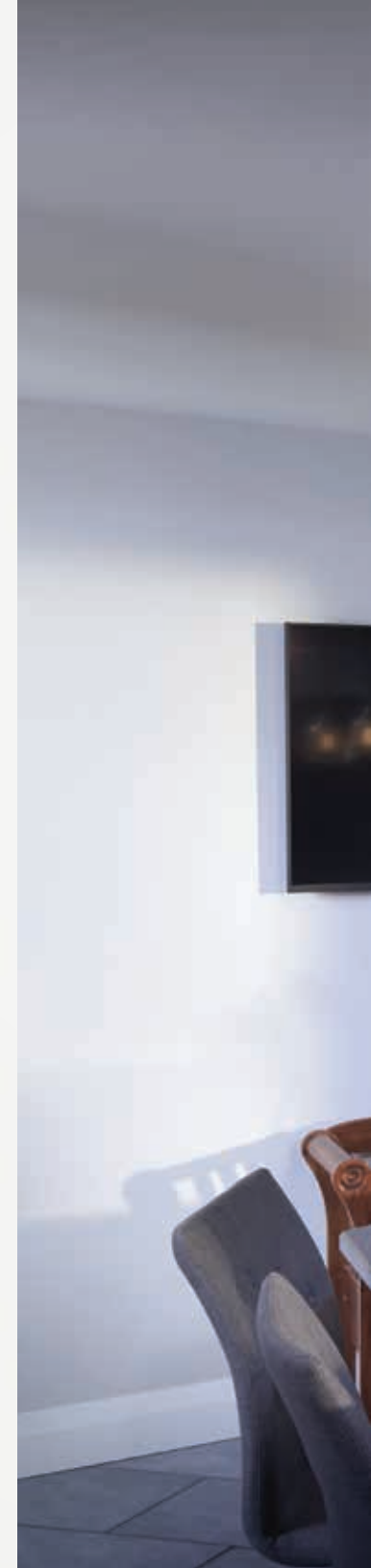



The Living Room, Kitchen and Bedroom are prime targets for creating Hot Spots. If you get these rooms right, you've nailed it!

GT8

6,000 BTU's

Viewing Area: 10 1/2" W x 26" H

For more detailed specifications on this unit, see page 22

The Torch™ shown with Metallic Black Surround.

Vittoria™

Modern Simplicity

Its sleek, tall, slender design, the Vittoria™ gas fireplace easily installs into smaller wall applications... perfect for entranceways and corner wall installations. With the choice of a traditional log set and facing kits or mineral rock setting and contemporary facing kits, the Vittoria™ offers two entirely different looks. The Vittoria™ features Napoleon's exclusive NIGHT LIGHT™, electronic ignition with battery back-up and heat radiating ceramic glass. Either choice, traditional or modern, the Vittoria™ is the perfect fireplace for smaller living spaces.

Options & Accessories



Ornamental Insets, Painted Metallic Black Finish



F45 & F60 Remote Controls On/Off with Digital Screen



Exclusive NIGHT LIGHT™



Mineral Rock Burner Assembly

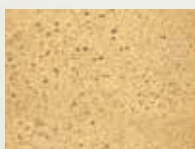

Decorative Sandstone Brick/Stone Panels

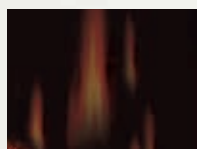

MIRRO-FLAME™ Porcelain Reflective Radiant Panels



Contemporary Black Surround



Contemporary Brushed Stainless Steel Surround



Traditional Hammertone Pewter Surround

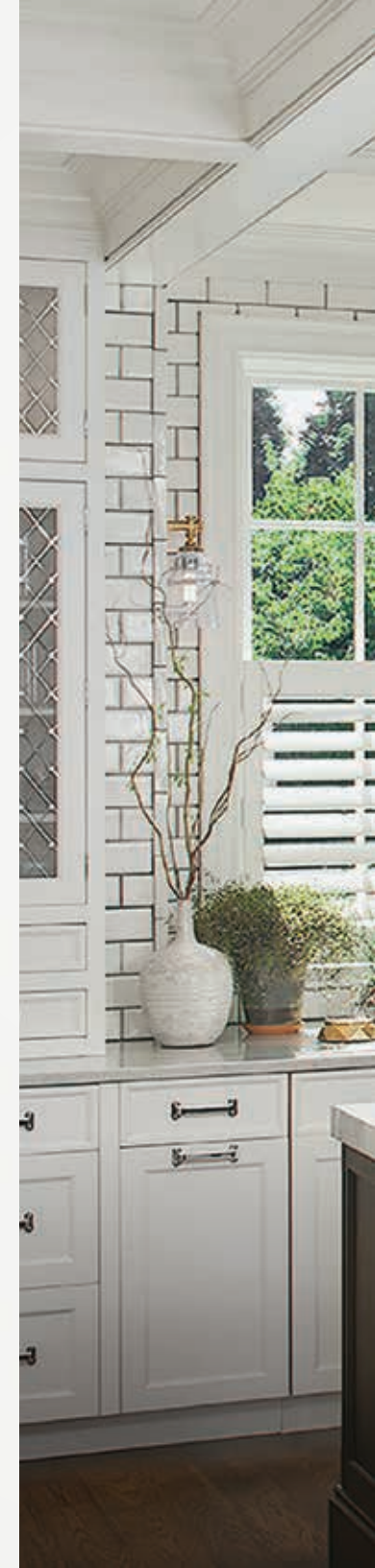



GD19

Up to 11,500 BTU's
Viewing Area: 16 5/8" W x 24" H

For more detailed specifications on this unit, see page 22

The Vittoria™ shown with Traditional Hammertone Pewter Surround and Log Burner Assembly.

Park Avenue™

European Styling

This tall, dark, handsome fireplace features a unique, clean design with advanced burner technology, creating the most realistic flames in the industry. The Park Avenue™ deluxe model is offered as a complete package including an exclusive NIGHT LIGHT™, heat circulating blower, multi-function remote control (controlling the flame, blower and NIGHT LIGHT™) and PHAZERAMIC™ advanced flame burner technology. Exclusive designer accessories make the Park Avenue™ perfect for any room in your home.



Rectangular Black Heritage Surround

Options & Accessories



Andirons



Remote Control (Included)



Sandstone Herringbone
Decorative Brick Panels



Exclusive NIGHT LIGHT™

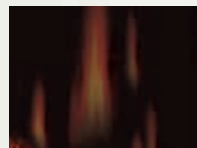

MIRRO-FLAME™ Porcelain
Reflective Radiant Panels



Brushed Stainless Steel Surround and
Hearth Pad

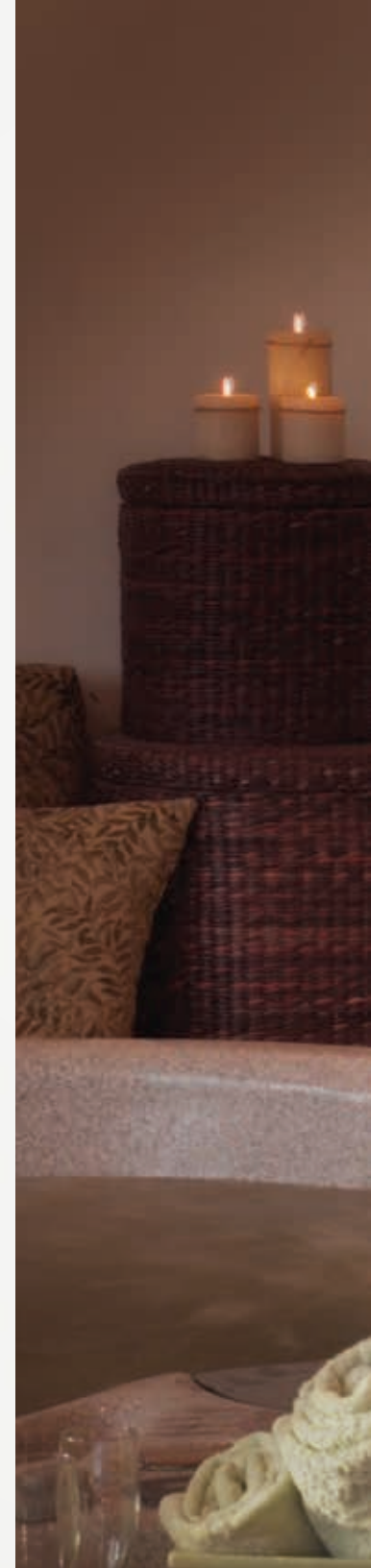



A fireplace can be placed over tub to add warmth and intimacy to the room. Incorporate great light, privacy and beauty into these spaces for added appeal.



GD82T-PAE

Up to 26,000 BTU's

Viewing Area: 22" W x 29" H

For more detailed specifications on this unit, see page 23

The Park Avenue[®] shown with Arched Black Heritage Surround and Herringbone Sandstone Brick Panels.

Tureen™

Style and Elegance

Napoleon's Tureen™ features a totally unique modern style, a heavy gauge Medallion™ burner system, an exclusive NIGHT LIGHT™, stylish river rocks and a remarkable towering flame. The contemporary ceramic bowl, decorative accessories and concave satin chrome reflective panel give the Tureen™ its impressive design, certain to create a dynamic and extraordinary focal point wherever it is installed.

Options & Accessories



Remote Control (Included)

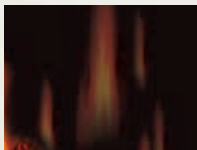

MIRRO-FLAME™ Porcelain Reflective Radiant Panels



Rectangular Black Surround



Arched Black Heritage Pattern Surround

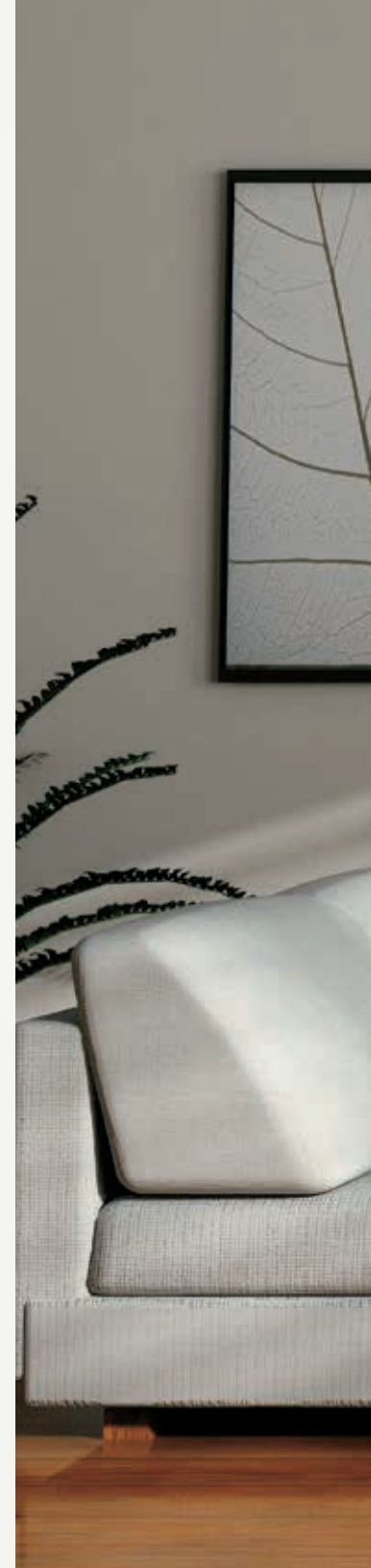



GD82T-TE

Up to 26,000 BTU's

Viewing Area: 22" W x 29" H

For more detailed specifications on this unit, see page 23

The Tureen shown with Brushed Stainless Steel Surround and Hearth Pad.

Plazmafire™ 31

Easy Installation

Ideal for modern and contemporary rooms, Napoleon's Plazmafire™ 31 features easy installation and all of the conveniences of a direct vent gas fireplace. Virtually endless installation possibilities, it's almost as easy as hanging a picture on the wall. With an impressive viewing area, 20,000 BTU's, exclusive Topaz CRYSTALINE™ ember bed and slate brick panels, Napoleon's Plazmafire™ is a great addition to our modern fireplace collection and to any room in your home.



Painted Black Rectangular Surround

Options & Accessories



F45 & F60 Remote Controls
On/Off with Digital Screen

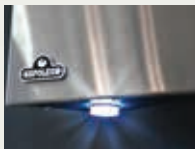

LED Light Kit
Two Lights Included



Slate Brick Panel
(included)



Blue Glass Embers



Amber Glass Embers



Black Glass Embers



Red Glass Embers



Topaz Glass Embers
(Included)



Clear Glass Embers





WHD31

20,000 BTU's

Viewing Area: 31 1/2" W x 16 1/2" H

For more detailed specifications on this unit, see page 24

The Plazmafire® 31 shown with Brushed Stainless Steel Convex Surround.

Plazmafire™ 48

Stunning Appearance

Napoleon's wall hung Plazmafire™ 48 is a beautiful, modern gas fireplace. Designed with a focus on ease of installation, requires no special framing and can be quickly mounted to an existing wall with its simple mounting bracket. With virtually endless installation possibilities, it's almost as easy as hanging a picture on the wall. The Plazmafire™ 48 comes complete with MIRRO-FLAME™ Porcelain Reflective Radiant Panels and CRYSTALINE™ Topaz glass embers.



Painted Black Rectangular Surround

Options & Accessories



Proflame II Remote Control (Included)



eFIRE Remote App with Proflame II System Available (Optional)



LED backlit light kit



Blue Glass Embers



Amber Glass Embers



Black Glass Embers



Red Glass Embers



Topaz Glass Embers (Included)

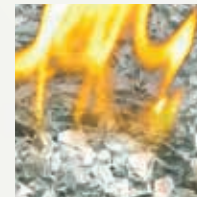

Clear Glass Embers





Napoleon's Hot Spots Research Study divulges how over 90% of people surveyed strongly desire a fireplace in the family / living room.



WHD48

Up to 26,000 BTU's

Viewing Area: 36 1/2" W x 16 1/2" H

For more detailed specifications on this unit, see page 24

The Plazmafire® 48 shown with Brushed Stainless Steel Rectangular Surround.

Crystallo™

It's Crystal Clear...

A clean face design with an exclusive CRYSTALINE™ ember bed embraces Napoleon's collection of modern fireplaces. The Crystallo™ provides inspiration to create a hearth experience that focuses on warmth, beauty and style. The Crystallo™ comes included with MIRRO-FLAME™ Porcelain Reflective Radiant Panels and a multi-function LED spectrum light strip. The LED light strip transitions through the entire RGB color range or can be set to any color (including white) that suits your décor and act as an exclusive NIGHT LIGHT™. A unique hearth idea that sparkles with modern elegance!



F45 & F60 Remote Controls
On/Off with Digital Screen

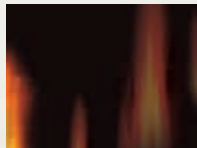

MIRRO-FLAME™ Porcelain
Reflective Radiant Panels
(included)



Satin Chrome Lower Trim



Blue Glass Embers



Amber Glass Embers



Black Glass Embers



Red Glass Embers



Topaz Glass Embers
(Included)

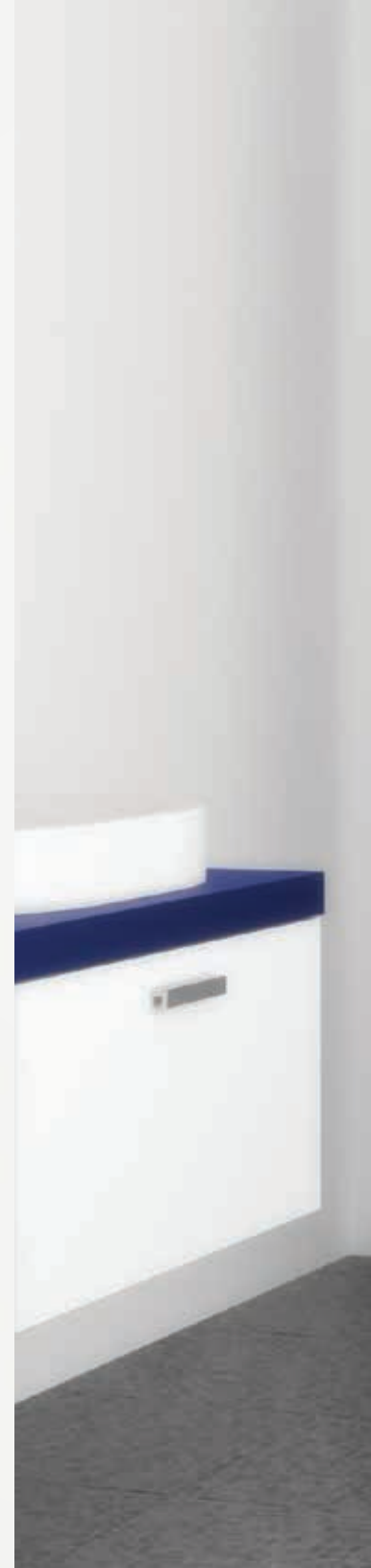



BGD36CFG

Up to 17,000 BTU's

Viewing Area: 40" W x 34" H

For more detailed specifications on this unit, see page 25

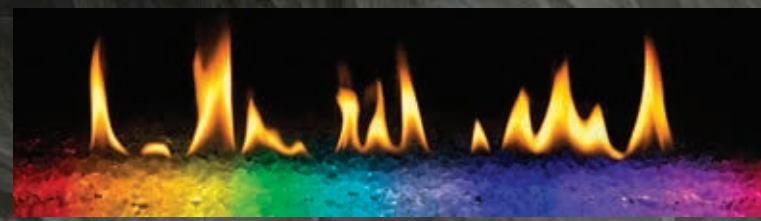

LED Spectrum Light Strip

The LED lights transition through an array of colors based on an RGB color spectrum (feature image shown above shows the color range, ember bed will only show one color at a time)

The Crystallo™ Shown with Diamond Dust Convex Surround and LED Lights Set on Blue.

Grandville™ 36 CF

Best of Both Worlds

The Napoleon Grandville™ 36 CF gas fireplace with heat radiating glass, beautiful display of YELLOW DANCING FLAMES® and realistic PHAZER® log set makes it the perfect complement to a crisp, contemporary design. The perfect fireplace for those wanting a traditional look but a clean face contemporary style, the Grandville™ 36 CF gives you the best of both worlds.



F45 & F60 Remote Controls
On/Off with Digital Screen

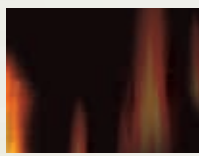

MIRRO-FLAME™ Porcelain
Reflective Radiant Panels
(included)

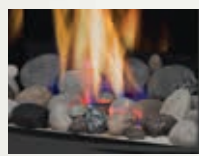

Mineral Rock Kit



Diamond Dust Convex Surround





BGD36CF

Up to 17,000 BTU's

Viewing Area: 40" W x 34" H

For more detailed specifications on this unit, see page 25

The Grandville™ 36 CF shown with standard Clean Face Front and Mineral Rocks.

Outstanding Features

of Napoleon's Advanced Technology



Advanced Burner Technology

Napoleon's sophisticated burner system offers superior flame technology. Strategically placed burner ports create the most realistic YELLOW DANCING FLAMES® in the industry.

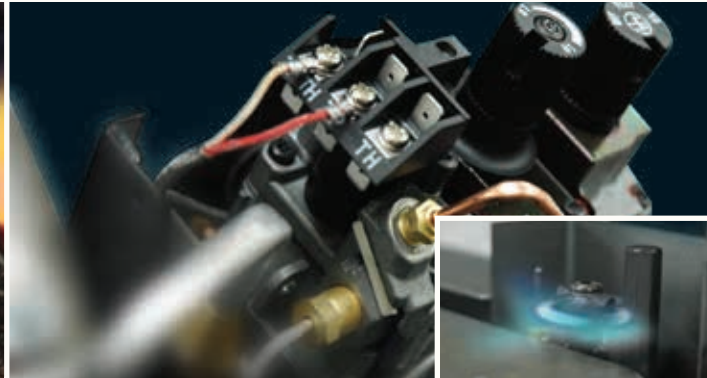

Finely Tuned Precision Valves

Surrounded with a protective cast aluminum jacket, the precision valves allow for ultimate reliability and 100% SAFE GUARD™ gas control system.

Minimum 30% savings on heating costs with Zone Heating

Zone Heating means you are heating the rooms that you use the most with an alternate heat source, like a Napoleon gas fireplace. Zone Heating is the obvious solution for families concerned about rising fuel costs.

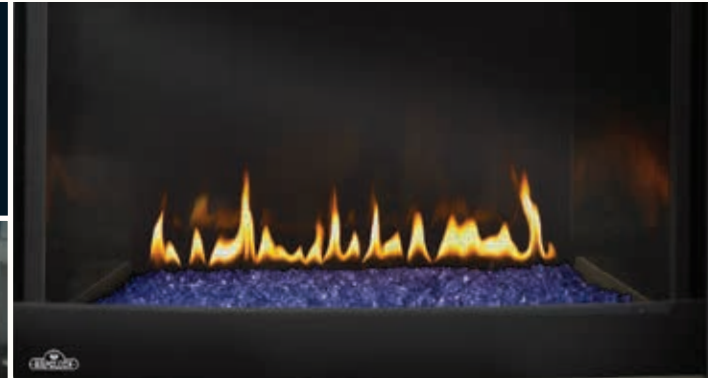

Outstanding Craftsmanship

Fine details are designed in every aspect of Napoleon fireplaces... individually handcrafted with pride of excellence to last a lifetime.

Safety Screens

Napoleon, leaders in design & technology have developed safety screens with aesthetically pleasing designs for every gas appliance to ensure ultimate safety and peace of mind for your family.

Outstanding Features of Napoleon's Advanced Technology

Direct Vent System

1. Zero clearance to combustible framing*
2. Forced convection heated room air
3. Radiant heat
4. High Heat Ceramic or Tempered Glass increases the radiant heat that is dispersed throughout the room. Save up to 30% on energy costs with radiant heat and Zone Heating
5. Cool room air is naturally drawn through the lower opening, circulates around the firebox, and expels into the living space as warm air
6. Optional air circulating variable speed blower with high temperature bearings increases efficient heating
7. Advanced ceramic burner system (selected models)
8. MIRRO-FLAME® Porcelain Reflective Radiant Panels further increase radiant heat (optional on most models)
9. Advanced burner technology produces the most realistic flames in the industry
10. Sealed combustion chamber
11. Optional rear exhaust (selected models)

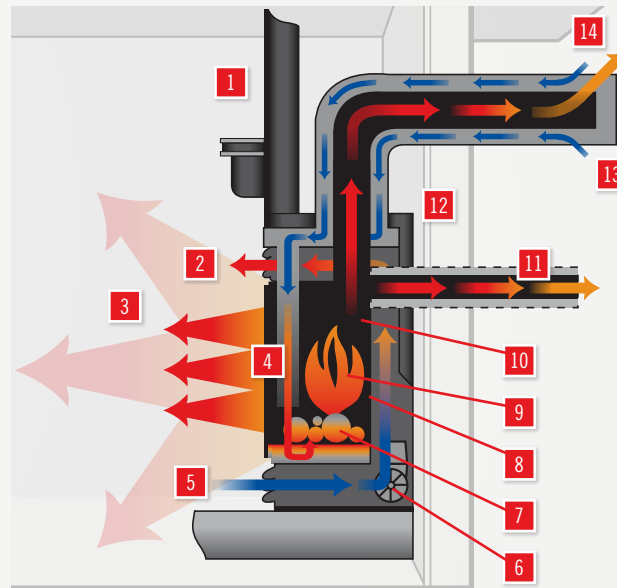

12. Efficient heat exchange system
13. Combustion air inlet
14. Flue gas outlet

With over 35 years of research and development, Napoleon has perfected direct vent technology to offer you a fireplace, stove or insert that easily fits into your lifestyle.

With Napoleon's direct vent technology, you can design and install your fireplace in unique locations where it wasn't possible before with traditional masonry fireplaces. Even your basement can be transformed into a warm, inviting oasis for your family and friends to enjoy.

Whether you are renovating, building or replacing an inefficient fireplace product, Napoleon helps guide you in the right direction to find the product that's right for you and your home. Napoleon Fireplaces are a smart investment that will bring many years of affordable luxury to you and your family.

*See installation manual for details

Direct Vent Power Venting System

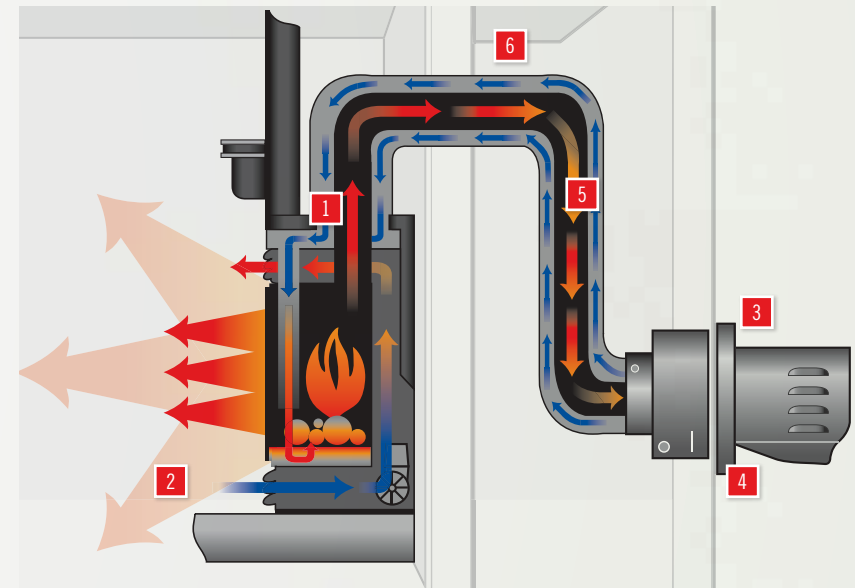

1. Suitable for exhaust products with various vent diameters
2. Installation friendly maintenance free durable construction
3. Blower mounted outside at terminal with WHISPER QUIET® operation inside
4. Terminates above or below the fireplace to allow more freedom and versatility for direct vent installations
5. No hoses to terminal
6. Ability to "snake" either up, down or around objects (ie; behind stairways)

Napoleon's power venting system allows more freedom and versatility for direct vent installations. The option of having the termination above or below the fireplace, along with the ability to "snake" either up or down, allows installation when the desired fireplace location is a great distance away from an outside wall. The blower that pulls the burned gases from the fireplace is mounted outside at the terminal which provides WHISPER QUIET® operation inside the home.

Available for Select Models

Torch®

Shown on pages 4 & 5

*Fronts/Surrounds may change unit dimensions

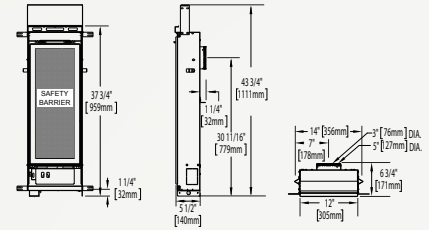

Model	BTU's (Input)		Venting 4" x 7"	Height		Front Width		Depth		Glass Type	Viewing Area		Efficiencies EnerGuide	Blower	Mobile Home Certified
	Natural Gas	Propane		Actual	Framing	Actual	Framing	Actual	Framing		Height	Width			
GT8	6,000	6,000	Rear	43 3/4"	44 1/4"	12"	14 1/2"	6 3/4"	7"	Ceramic	26"	10 1/2"	58%	N/A	Yes

Certified under Canadian and American National Standards.

Vittoria™

Shown on pages 6 & 7

*Fronts/Surrounds may change unit dimensions

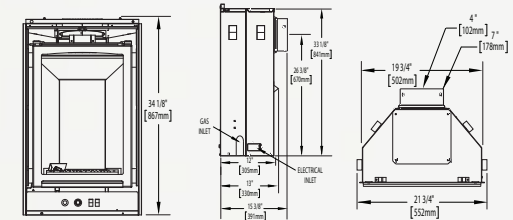

Model	BTU's (Input)		Venting 4" x 7"	Height		Front Width		Depth		Glass Type	Viewing Area		Efficiencies EnerGuide	Blower	Mobile Home Certified
	Natural Gas	Propane		Actual	Framing	Actual	Framing	Actual	Framing		Height	Width			
GD19	11,500	11,000	Top/Rear	34 1/8"	34 3/8"	21 3/4"	22 1/4"	13"	13 1/4"	Ceramic	24"	16 5/8"	55.9%	Optional	Yes

Certified under Canadian and American National Standards.

Park Avenue™

Shown on pages 8 & 9

*Fronts/Surrounds may change unit dimensions

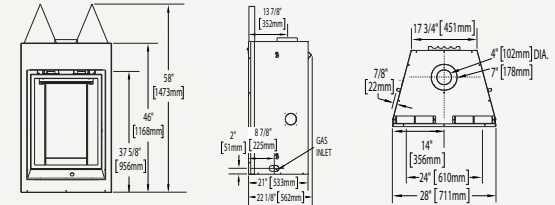

Model	BTU's (Input)		Venting 4" x 7"	Height		Front Width		Depth		Glass Type	Viewing Area		Efficiencies		Blower	Mobile Home Certified
	Natural Gas	Propane		Actual	Framing	Actual	Framing	Actual	Framing		Height	Width	EnerGuide	AFUE		
GD82T-PAE	26,000	26,000	Top	58"	58 1/4"	28"	29"	22 1/8"	22 1/2"	Ceramic	29"	22"	54.4%	56%	Optional	Yes

Certified under Canadian and American National Standards.

Tureen™

Shown on pages 10 & 11

*Fronts/Surrounds may change unit dimensions

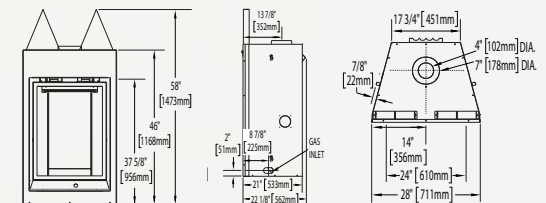

Model	BTU's (Input)		Venting 4" x 7"	Height		Front Width		Depth		Glass Type	Viewing Area		Efficiencies		Blower	Mobile Home Certified
	Natural Gas	Propane		Actual	Framing	Actual	Framing	Actual	Framing		Height	Width	EnerGuide	AFUE		
GD82T-TE	26,000	26,000	Top	58"	58 1/4"	28"	29"	22 1/8"	22 1/2"	Ceramic	29"	22"	54%	56%	Included	Yes

Certified under Canadian and American National Standards.

Figures may vary with individual conditions such as floor plan layout, insulation value/heat loss of the house and geographical location. Measurements to be used as a guide only. Consult your owner's manual for complete and up-to-date installation instructions and proper clearances to combustible materials.

Plazmafire™ 31

Shown on pages 12 & 13

*Fronts/Surrounds may change unit dimensions

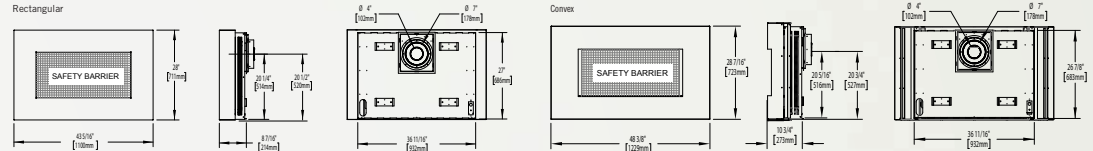

Model	BTU's (Input)		Venting 4" x 7"	Height		Front Width		Depth		Glass Type	Viewing Area		Efficiencies EnerGuide	Blower	Mobile Home Certified
	Natural Gas	Propane		Actual	Framing	Actual	Framing	Actual	Framing		Height	Width			
WHD31 - Rectangular	20,000	16,000	Rear	28"	N/A*	43 5/16"	N/A*	8 7/16"	N/A*	Ceramic	16 1/2"	31 1/2"	65.2%	N/A	Yes
WHD31 - Convex	20,000	16,000	Rear	28 7/16"	N/A*	48 3/8"	N/A*	10 3/4"	N/A*	Ceramic	16 1/2"	31 1/2"	65.2%	N/A	Yes

Certified under Canadian and American National Standards.

Plazmafire™ 48

Shown on pages 14 & 15

*Fronts/Surrounds may change unit dimensions

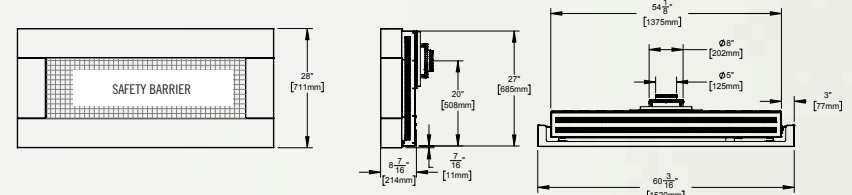

Model	BTU's (Input)		Venting 5" x 8"	Height		Front Width		Depth		Glass Type	Viewing Area		Efficiencies EnerGuide	Blower	Mobile Home Certified
	Natural Gas	Propane		Actual	Framing	Actual	Framing	Actual	Framing		Height	Width			
WHD48	28,000	28,000	Rear	28"	N/A	60 3/16"	N/A	8 7/16"	N/A	Ceramic	16 1/2"	36 1/2"	72.38%	N/A	Yes

Certified under Canadian and American National Standards.

Crystallo™ - BGD36CFG

Shown on pages 16 & 17

*Fronts/Surrounds may change unit dimensions

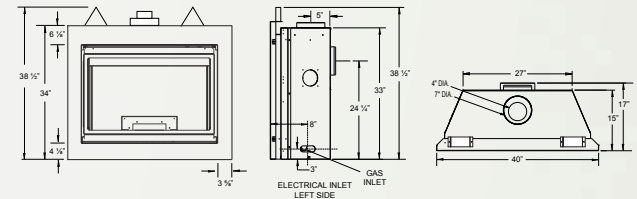

Model	BTU's (Input)		Venting 4" x 7"	Height		Front Width		Depth		Glass Type	Viewing Area		Efficiencies		Blower	Mobile Home Certified
	Natural Gas	Propane		Actual	Framing	Actual	Framing	Actual	Framing		Height	Width	EnerGuide	AFUE		
BGD36CFG	17,000	17,000	Top/Rear	38 1/2"	38 3/4"	40"	40 1/2"	17"	17 1/4"	Tempered	19"	31 1/4"	59.4%	53%	Optional	Yes

Certified under Canadian and American National Standards.

Granville™ 36 - BGD36CF

Shown on pages 18 & 19

*Fronts/Surrounds may change unit dimensions

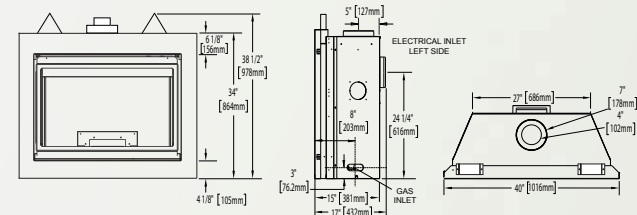

Model	BTU's (Input)		Venting 4" x 7"	Height		Front Width		Depth		Glass Type	Viewing Area		Efficiencies		Blower	Mobile Home Certified
	Natural Gas	Propane		Actual	Framing	Actual	Framing	Actual	Framing		Height	Width	EnerGuide	AFUE		
BGD36CF	17,000	17,000	Top/Rear	38 1/2"	38 3/4"	40"	40 1/2"	17"	17 1/4"	Tempered	19"	31 1/4"	72.6%	53%	Optional	Yes

Certified under Canadian and American National Standards.

Figures may vary with individual conditions such as floor plan layout, insulation value/heat loss of the house and geographical location. Measurements to be used as a guide only. Consult your owner's manual for complete and up-to-date installation instructions and proper clearances to combustible materials.



NAPOLEON - CELEBRATING OVER 40 YEARS OF HOME COMFORT PRODUCTS



24 Napoleon Road, Barrie, Ontario, Canada L4M 0G8
103 Miller Drive, Crittenden, Kentucky, USA 41030
7200 Trans Canada Highway, Montreal, Quebec, Canada H4T 1A3

Tel: 1-866-820-8686
napoleonfireplaces.com

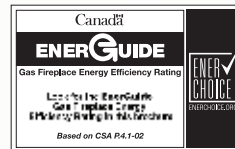

Authorized Dealer

Consult your owner's manual for complete installation instructions and proper clearances to combustible materials. Check all local and national building codes and gas regulations. All specifications are subject to change without prior notice due to on-going product improvements. Products may not be exactly as shown. Flame height and activity is influenced by varying vent configurations and may not appear as shown. Napoleon is a registered trademark of Wolf Steel Ltd. © Wolf Steel Ltd. EnerGuide - A Canadian efficiency standard based on frequent, short start-up and cool-down cycles. All appliances sold in Canada are subject to this EnerGuide rating system. AFUE - A US efficiency standard (Department of Energy) based on extended on/off cycles, more typical of fireplace usage. Steady State - Reflects the highest possible overall heating efficiency.

NAPOLEON

LINEAR SERIES GAS FIREPLACES



LINEAR SERIES GAS FIREPLACES
napoleon.com



Linear Gas Fireplaces. Limitless Possibilities.

Napoleon's linear gas fireplaces, the award-winning Vector™ and Luxuria™ series, as well as the Ascent™ Linear provides you with an elegant fire element allowing the flames radiant glow to enhance every room

Napoleon's innovative Bluetooth enabled **eFIRE** app can be accessed from your mobile device and used to control everything on your fireplace (flame height, LED ember bed colors, blower and more).

Napoleon's industry leading Heat Management allows for installation of combustible materials up to the fireplace opening. This heat management system eliminates the need for loud power vents, fan systems or blowers to provide better heat distribution. Take advantage of simple installation framing and easily install your televisions, sound bars or artwork above the fireplace to truly customize your home decor thanks to the drastically reduced temperatures above the fireplace.

Vector™ Series	3 - 9
Luxuria™ Series	10 - 15
Ascent™ Linear Series	16 - 21
Media Options	22
Napoleon's Heat Management	23 - 25
Detailed Specifications & Line Drawings	26 - 27

Please note, colors and finishes of decorative panels, log sets and accessories may vary.





See your dream fireplace come to life in front of your eyes! Scan here to visit Napoleon's Fireplace Design Studio and build your custom fireplace with available design options.



Vector™ Series

Sophisticated Fires

Napoleon's Vector™ series of linear gas fireplaces is the perfect fit for any room to make a statement in your home. Customize your fireplace with our selection of designer surrounds, choose a different surround for either side of the See Through Vector™ units to match or enhance your current décor. Napoleon's Vector™ Series can also be dressed to match any interior design with dozens of media options available, the possibilities are endless. Optional Dynamic Heat Control or Ducted Heat Management allow for zero clearance to combustibles and designed for TV installations.

Available Sizes:



Features



Remote Control (Included)



Choice of Glass Beads or CRYSTALINE™ Ember Bed



MIRRO-FLAME™ Porcelain Reflective Radiant Panels (Included)



End Panel Kit available on single sided Vector™ Series fireplaces.



eFIRE controller application available free on iTunes and Google Play store

Mobile Device Controlled

Napoleon's eFIRE app will revolutionize the way you use your fireplace. We have cracked the code and present to you the first fireplace to be controlled by Bluetooth® technology, using an intuitive app on your mobile device.

The eFIRE application allows you to create every imaginable color, selecting the one that fits your current mood or your décor with ease. The simple color wheel tool swiftly scrolls through the full color spectrum. Napoleon's eFIRE app controls every function of your fireplace including; on/off, flame height and blower speed for total convenience.

Vector™ 62 featured on page 8

Style & Size Options

Various Models, Media Kits, Surrounds and Trims Shown



Black Premium Safety Barrier
Shown on Single Sided Vector™ 38 with
Wrought Iron Globe Kit on Topaz Glass Embers



Black Premium Safety Barrier and 1" Finishing Trim
Shown on See Through Vector™ 50 with Contemporary Logs
and Shore Fire Kit



Black Premium Safety Barrier
Shown on Single Sided Vector™ 74 with Wrought Iron Globe Kit on
Topaz Glass Embers



Classic Black Surround
Shown on See Through Vector™ 38 with Shore
and Beach Fire Kits combined

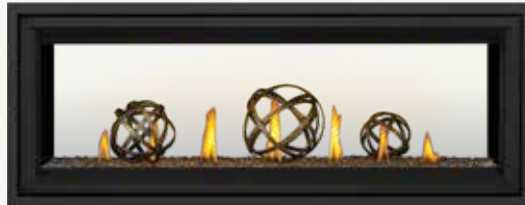

Black Premium Safety Barrier and 1" Finishing Trim
Shown on See Through Vector™ 50 with Wrought Iron Globe
Kit on Topaz Glass Embers



Black Premium Safety Barrier
Shown on See Through Vector™ 74 with Beach Fire Kit on Clear Glass Beads



Brushed Stainless Steel Surround
Shown on Single Sided Vector™ 38 with Premium
Birch Logs and Shore Fire Kit



**Brushed Stainless Steel Premium Safety Barrier
and 1" Finishing Trim**
Shown on Single Sided Vector™ 50 with Shore and Beach
Fire Kits combined



Brushed Stainless Steel Premium Safety Barrier
Shown on Single Sided Vector™ 74 with Premium Birch Logs and Shore Fire Kit



Brushed Stainless Steel Surround
Shown on Single Sided Vector™ 38 with Premium
Birch Logs and Shore Fire Kit



**Brushed Stainless Steel Premium Safety Barrier
and 1" Finishing Trim**
Shown on Single Sided Vector™ 50 with Shore Fire Kit



Black 4 Sided Finishing Trim
Shown on Single Sided Vector 74 with Nickel Stix and Black Glass Beads

Vector™ 38

Single-Sided & See Through Models

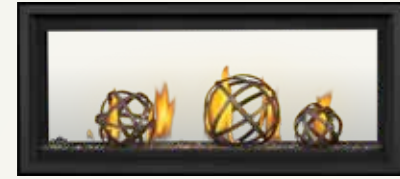

See Through Vector™ 38 - Black Premium Safety Barrier



Single Sided Vector™ 38 - Classic Black Surround

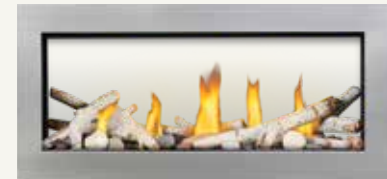

See Through Vector™ 38 - Brushed Stainless Steel Surround



Single Sided Vector™ 38 - Black Premium Safety Barrier

LV38N-1 / LV38N2-1

Up to 30,000 BTU's

Viewing Area: 18 5/8" h x 40 3/4" w

Propane Conversion Kit sold separately

For more detailed specifications on this unit, see pages 26 - 27



See Through Vector™ 50 - Black Premium Safety Barrier



Single Sided Vector™ 50 - Black Premium Safety Barrier

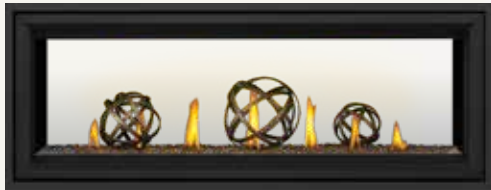

See Through Vector™ 50 - Black Premium Safety Barrier and 1" Black Finishing Trim



Single Sided Vector™ 50 - Brushed Stainless Steel Premium Safety Barrier and 1" Stainless Steel Finishing Trim

LV50N-2 / LV50N2-2

Up to 36,000 BTU's

Viewing Area: 18 5/8" h x 52 3/4" w

Propane Conversion Kit sold separately

For more detailed specifications on this unit, see pages 26 - 27

Vector™ 50

Single-Sided & See Through Models

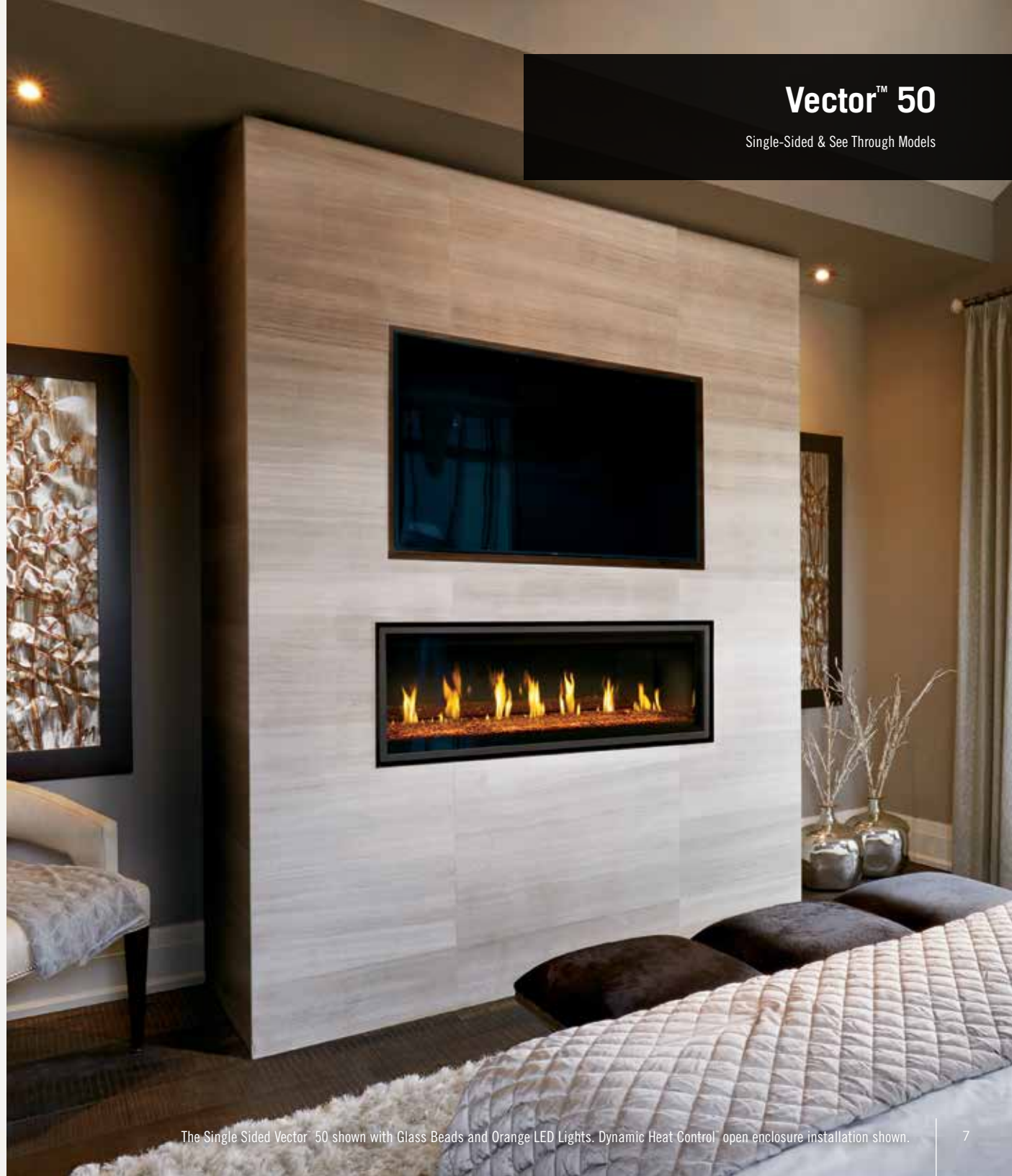

Vector™ 62

Single-Sided & See Through Models



Single Sided Vector™ 62 - Brushed Stainless Steel Premium Safety Barrier

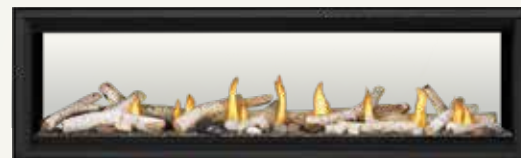

See Through Vector™ 62 - Black Premium Safety Barrier



Single Sided Vector™ 62 - Black Premium Safety Barrier

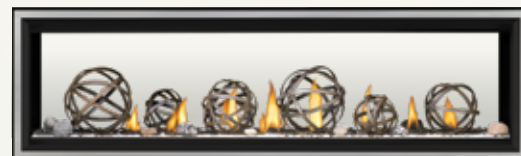

See Through Vector™ 62 - Brushed Stainless Steel Premium Safety Barrier



See Through Vector 62 - Black 4 sided Finishing Trim

LV62N / LV62N2

Up to 42,000 BTU's

Viewing Area: 18 5/8" h x 64 3/4" w

Propane Conversion Kit Sold Separately

For more detailed specifications on this unit, see pages 26 - 27

The See Through Vector™ 62 shown with Brushed Stainless Steel Premium Safety Barrier, Beach and Shore Fire Kits combined. Dynamic Heat Control™ hard valance installation shown.

Vector™ 74

Single-Sided & See Through Models



Single Sided Vector™ 74 - Black Premium Safety Barrier

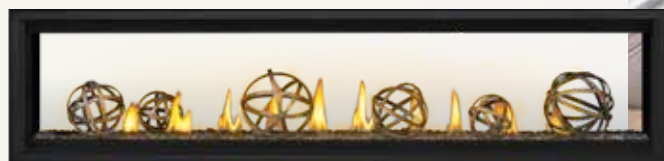

See Through Vector™ 74 - Black Premium Safety Barrier



Single Sided Vector™ 74 - Brushed Stainless Steel Premium Safety Barrier

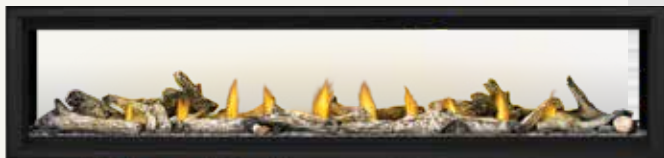

See Through Vector™ 74 - Black Premium Safety Barrier



Single Sided Vector™ 74 - Black 4 sided Finishing Trim

LV74N/LV74N2 (NATURAL)

LV74P/LV74P2 (PROPANE)

Up to 48,000 BTU's

Viewing Area: 18 5/8" h x 76 3/4" w

For more detailed specifications on this unit, see pages 26 - 27



Luxuria™ Series

Limitless Possibilities

Make a spectacular statement with Napoleon's Luxuria™ series of gas fireplaces. Thanks to our Vesta Award winning Premium Glass Guard system, there is no safety screen required, enhancing your view of the brightest flames in the series. Choose a Single Sided unit or maximize your viewing pleasure with a See Through model. This versatile series allows for easy installation of electronics, artwork or other heat sensitive items directly above the unit, and combustible material to be installed flush to the opening. In combination with premium media options, the Luxuria™ series offers endless installation opportunities.

Available Sizes:



Features



Remote Control (Included)



Choice of Glass Beads or CRYSTALINE™ Ember Bed



MIRRO-FLAME™ Porcelain Reflective Radiant Panels



Premium Glass Guard



eFIRE controller application available free on iTunes and Google Play store

Mobile Device Controlled

Napoleon's eFIRE app will revolutionize the way you use your fireplace. We have cracked the code and present to you the first fireplace to be controlled by Bluetooth® technology, using an intuitive app on your mobile device.

The eFIRE application allows you to create every imaginable color, selecting the one that fits your current mood, or your décor with ease, the simple color wheel tool swiftly scrolls through the full color spectrum. Napoleon's eFIRE app controls every function of your fireplace including on/off, flame height and blower speed for total convenience.

Style & Size Options

Various Models and Media Kits Shown

Vector™ 50 featured on page 15



Single Sided Luxuria™ 38

Shown with Birch Logs and Shore Fire Kit



See Through Luxuria™ 62

Shown with Shore and Beach Fire Kits combined



Single Sided Luxuria™ 74

Shown with Contemporary Logs and Shore Fire Kit

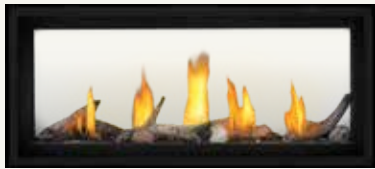

See Through Luxuria™ 38

Shown with Beach and Shore Fire Kits combined



Single Sided Luxuria™ 62

Shown with Birch Logs on Black Glass Beads

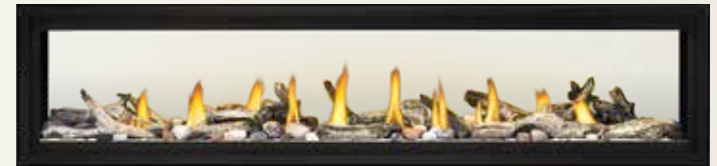

See Through Luxuria™ 74

Shown with Beach and Shore Fire Kits combined



Single Sided Luxuria™ 38

Shown with Wrought Iron Globes on Clear Glass Beads



See Through Luxuria™ 62

Shown with Wrought Iron Globes and Shore Fire Kit



Single Sided Luxuria™ 74

Shown with Birch Logs on Clear Glass Beads

Luxuria™ 38

Single-Sided & See Through Models



Single Sided Luxuria™ 38

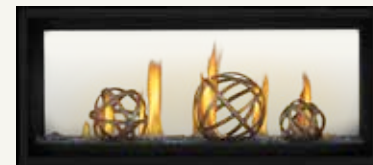

See Through Luxuria™ 38



Single Sided Luxuria™ 38

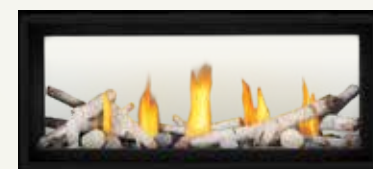

See Through Luxuria™ 38

LVX38NX-1 / LVX38N2X-1

Up to 31,000 BTU's

Viewing Area: 18 5/8" h x 42 1/8" w

For more detailed specifications on this unit, see pages 26 - 27



See Through Luxuria™ 50



Single Sided Luxuria™ 50

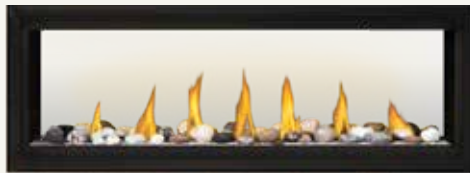

See Through Luxuria™ 50



Single Sided Luxuria™ 50

LVX50NX-1 / LVX50N2X-1

Up to 38,000 BTU's

Viewing Area: 18 5/8" h x 54 1/8" w

For more detailed specifications on this unit, see pages 26 - 27

Luxuria™ 50

Single-Sided & See Through Models

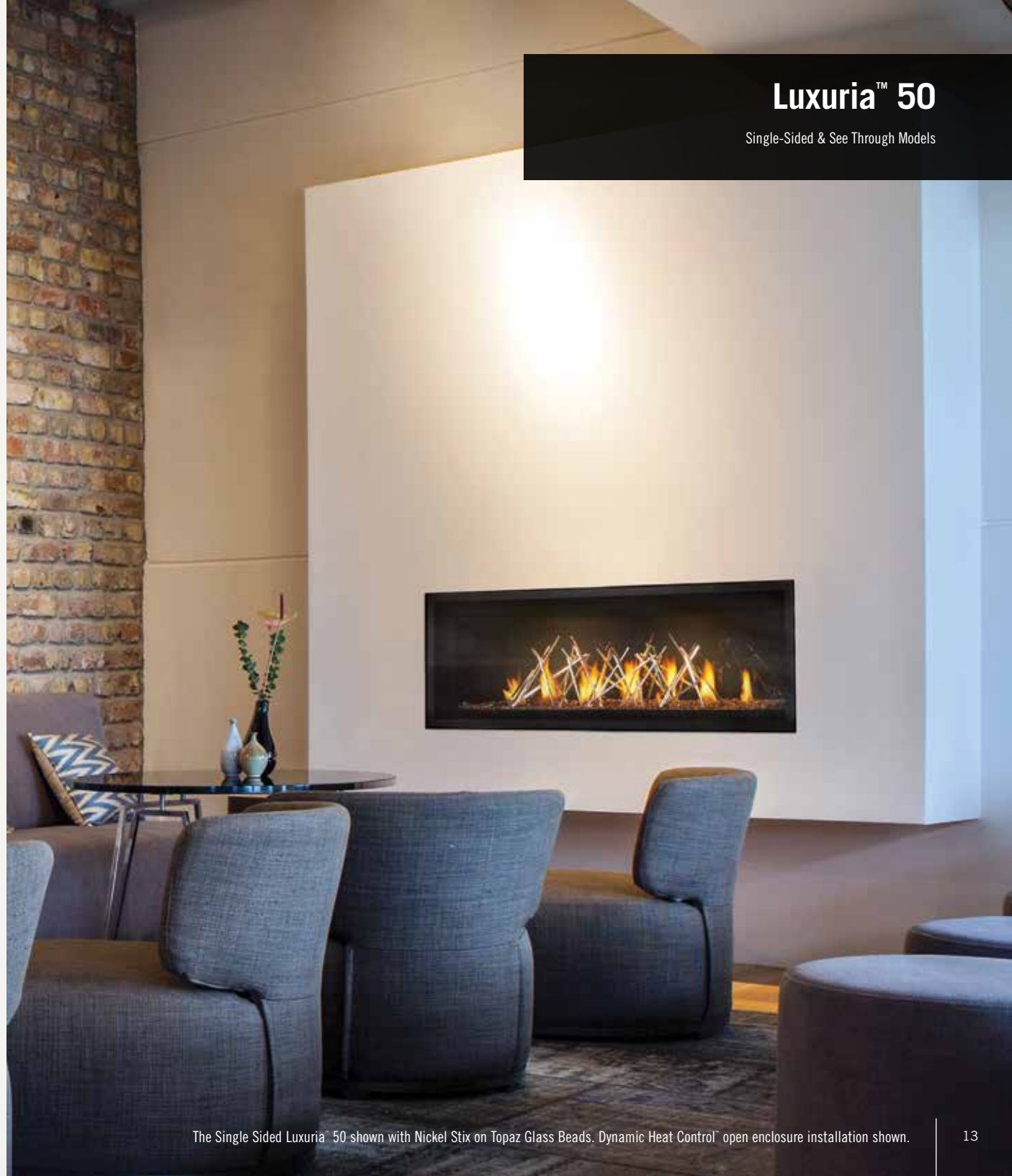

The Single Sided Luxuria™ 50 shown with Nickel Stix on Topaz Glass Beads. Dynamic Heat Control™ open enclosure installation shown.

Luxuria™ 62

Single-Sided & See Through Models



Single Sided Luxuria™ 62

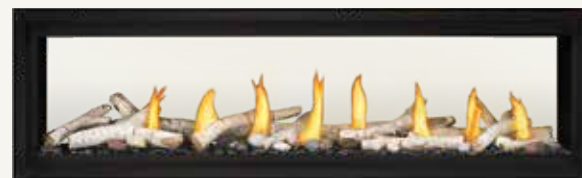

See Through Luxuria™ 62



Single Sided Luxuria™ 62



See Through Luxuria™ 62

LVX62NX-1 / LVX62N2X-1

Up to 44,000 BTU's

Viewing Area: 18 5/8" h x 66 1/8" w

For more detailed specifications on this unit, see pages 26 - 27

Luxuria™ 74

Single-Sided & See Through Models

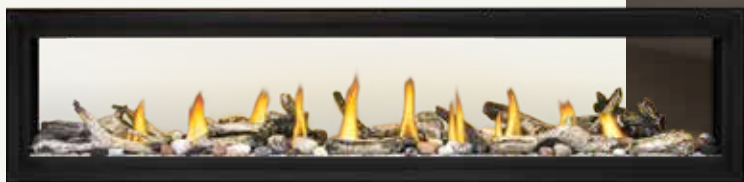

See Through Luxuria™ 74



Single Sided Luxuria™ 74

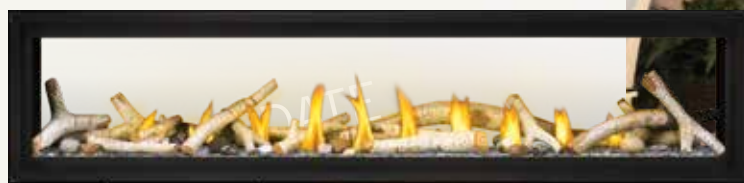

See Through Luxuria™ 74



Single Sided Luxuria™ 74

LVX74N/LVX74N2 (NATURAL)

LVX74PX/LVX74P2X (PROPANE)

Up to 50,000 BTU's

Viewing Area: 18 5/8" h x 78 1/8" w

For more detailed specifications on this unit, see pages 26 - 27



Ascent™ Linear Series

Boasts Beauty and Performance

With multiple designer options, Napoleon's Ascent™ Linear Gas Fireplace Series is ideal for making a dramatic statement in your home. A Topaz CRYSTALINE™ ember bed is included with the Ascent™ Linear and adds shimmer wherever it's installed. Customize the look by using the optional Beach Fire, Shore Fire, or Mineral Rock enhancement Kits, and you can even mix and match Kits to enhance your personal style. Use the optional eFIRE app and your favorite mobile device to control this fireplace with ease from the comfort of your chair. Available with Napoleon's industry-leading heat management systems, easily install your television, electronics and sensitive artwork closer to your fireplace, increasing design flexibility. Perfect for homeowners, remodelers and even builders who wish to add something special to a space.

Available Sizes:



Features



Optional F45 & F60 Remote Controls On/off with digital screen



Optional eFIRE Remote App



CRYSTALINE™ Ember Bed



eFIRE controller application available free on iTunes and Google Play store

Mobile Device Controlled

Napoleon's eFIRE app will revolutionize the way you use your fireplace. We have cracked the code and present to you the first fireplace to be controlled by *Bluetooth*® technology, using an intuitive app on your mobile device.

Optional with the Ascent Linear Series, the eFIRE application controls every function of your fireplace including on/off, flame height and blower speed for total convenience.

Style & Size Options

Various Models and Media Kits Shown



Ascent™ Linear™ 36

Shown with Glass Beads, and MIRRO-FLAME™ Porcelain Reflective Radiant Panels with Black Surround



Ascent™ Linear™ 42

Shown with Shore Fire Logset, and MIRRO-FLAME™ Porcelain Reflective Radiant Panels with Black Surround



Ascent™ Linear™ 46

Shown with Mineral Rock and MIRRO-FLAME™ Porcelain Reflective Radiant Panels and Black Surround



Ascent™ Linear™ 56

Shown with Topaz CRYSTALINE™ Ember Bed, and MIRRO-FLAME™ Porcelain Reflective Radiant Panels



Ascent™ Linear™ 36

Shown with Mineral Rock, and MIRRO-FLAME™ Porcelain Reflective Radiant Panels



Ascent™ Linear™ 42

Shown with Beach Fire Logset and MIRRO-FLAME™ Porcelain Reflective Radiant Panels



Ascent™ Linear™ 46

Shown with Beach and Shore Fire Media, and MIRRO-FLAME™ Porcelain Reflective Radiant Panels



Ascent™ Linear™ 56

Shown with Mineral Rock Logset, MIRRO-FLAME™ Porcelain Reflective Radiant Panels



Ascent™ Linear™ 36

Shown with Mineral Rock and Beach Fire Log Set, MIRRO-FLAME™ Porcelain Reflective Radiant Panels with Black Surround



Ascent™ Linear™ 42

Shown with Topaz CRYSTALINE™ Ember Bed, and MIRRO-FLAME™ Porcelain Reflective Radiant Panels



Ascent™ Linear™ 46

Shown with Topaz CRYSTALINE™ Ember Bed, and MIRRO-FLAME™ Porcelain Reflective Radiant Panels, and Black Surround



Ascent™ Linear™ 56

Shown with Beach and Shore Fire Media Kits, and MIRRO-FLAME™ Porcelain Reflective Radiant Panels with Black Surround

Ascent™ Linear 36



Ascent™ Linear 36 Shown with Glass Beads,
Black Surround



Ascent™ Linear 36 Shown with Mineral Rock
and Beach Fire logset and Black Surround



Ascent™ Linear 36 Shown with Shore Fire
logset and Black Surround

BL36-1

Up to 17,500 BTU's

Viewing Area: 18 13/16" h x 31 9/16" w

For more detailed specifications on this unit, see pages 26 - 27



Ascent™ Linear 42 Shown with Beach Fire and Shore Fire Logset and Black Surround



Ascent™ Linear 42 Shown with Shore Fire Logset and Black Surround



Ascent™ Linear 42 Shown with Mineral Rock Logset and glass Embers



Ascent™ Linear 42 Shown with Topaz CRYSTALINE™ Ember Bed

BL42

Up to 20,000 BTU's

Viewing Area: 18 13/16" h x 38 1/2" w

For more detailed specifications on this unit, see pages 26 - 27

Ascent™ Linear 42

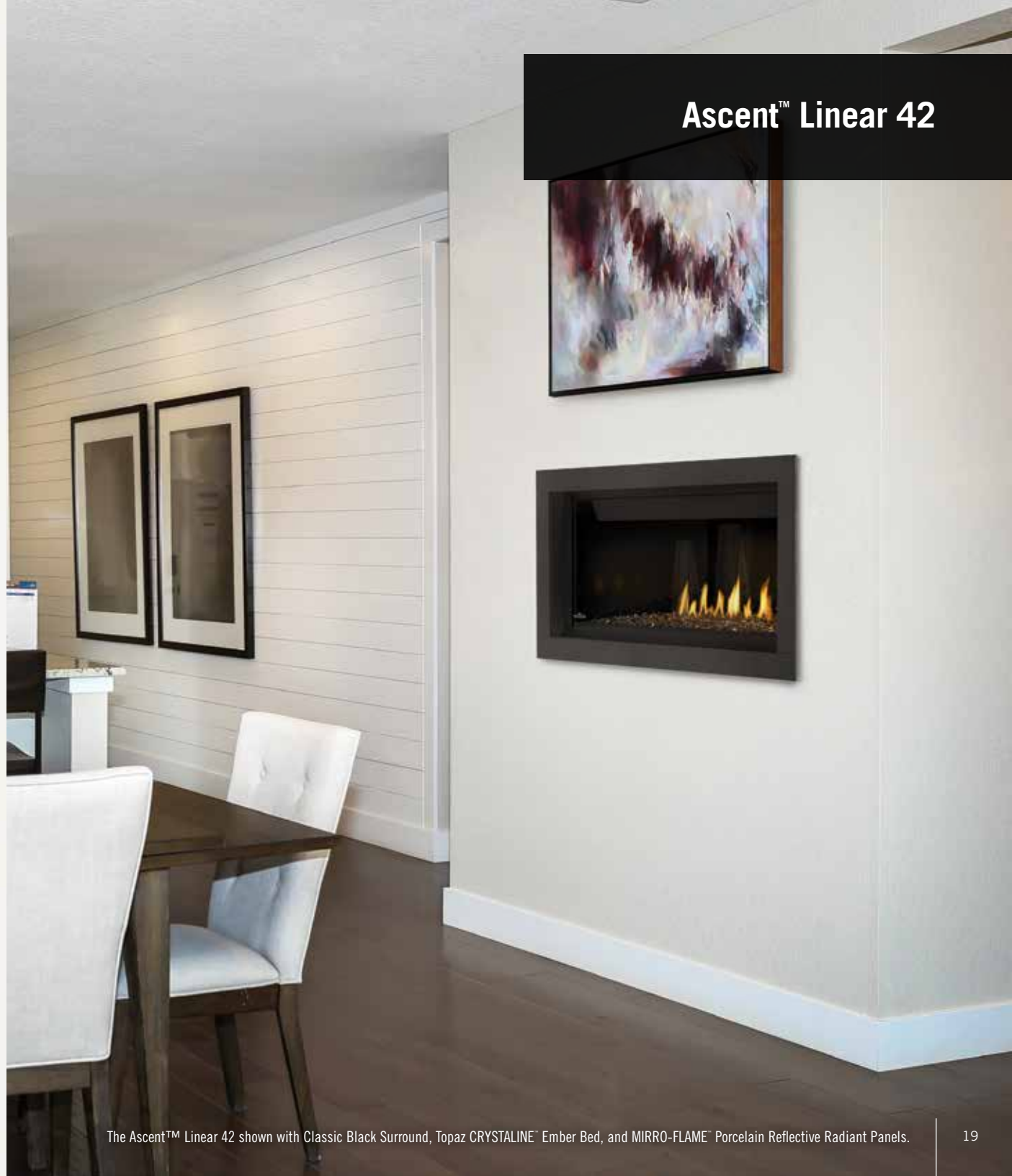

The Ascent™ Linear 42 shown with Classic Black Surround, Topaz CRYSTALINE™ Ember Bed, and MIRRO-FLAME™ Porcelain Reflective Radiant Panels.

Ascent™ Linear 46



Ascent™ Linear 46 Shown with Shore Fire and Beach Fire Logsets



Ascent™ Linear 46 with Topaz CRYSTALINE™ Ember Bed, Mineral Rock Logset and Black Surround

BL46

Up to 24,000 BTU's

Viewing Area: 18 13/16" h x 42 1/2" w

For more detailed specifications on this unit, see pages 26 - 27



Ascent™ Linear 56 Shown with Classic Surround and Shore Fire Logset



Ascent™ Linear 56 Shown with Classic Surround, Beach Fire and Shore Fire Logset



Ascent™ Linear 56 Shown with Mineral Rock Logset



Ascent™ Linear 56 Shown with Topaz CRYSTALINE™ Ember Bed

BL56

Up to 28,000 BTU's

Viewing Area: 18 13/16" h x 52 1/2" w

For more detailed specifications on this unit, see pages 26 - 27



Ascent™ Linear 56

Media Options



Premium Birch Log Kit with Shore Fire Kit



Beach Fire Kit



Shore Fire Kit (sand included)



Mineral Rock Kit



Beach Fire, Shore Fire and Mineral Rock Kits combined



Contemporary Log Kit on Shore Fire Kit*



Nickel Stix on Topaz Glass Embers*



Wrought Iron Globes with Shore Fire Kit*



Blue Glass Embers



Amber Glass Embers



Black Glass Embers



Topaz Glass Embers



Clear Glass Embers



Red Glass Embers

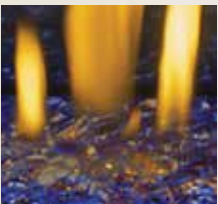

Blue Glass Beads



Amber Glass Beads



Black Glass Beads

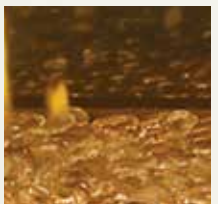

Topaz Glass Beads



Clear Glass Beads

*Available for Vector and Luxuria only.

FOCUSED ON VERSATILITY.

HEAT MANAGEMENT

Heat Management serves many purposes and offers several benefits. With our innovative systems, easily install your television, electronics and sensitive artwork closer to your fireplace, increasing design flexibility. These industry-leading technologies offer a more effective and quieter solution than standard blowers and operate without power. For a simpler installation, heat management reduces clearance to combustibles and allows for an easier installation of mantels. Finally, cooler glass and walls near the fireplace ensure that you and your family can safely enjoy the comfort and light of a gas fireplace. With our Heat Management Solutions, you control the heat.



UNIVERSAL HEAT MANAGEMENT

Using a set of ducts, the heat is efficiently circulated around the room instead of blowing directly from the front of the fireplace. Operating without the need for electrical or blowers, this is a silent system which is ideal for spending quality time with your loved ones watching a movie or reading. UHM lowers clearances for combustibles and allows for the safe installation of electronics above the fireplace.

Compatible with the Ascent™ Linear Series.



DYNAMIC HEAT CONTROL™



No ducting, fans or power required to circulate the heat ensuring silent operation. Allows you to design and build your space, completely integrating a fireplace into the décor with true zero clearance to combustible materials. An industry-leading system that has been designed for your TV or artwork to be installed directly above the fireplace. Napoleon's Luxuria™ Series fireplaces include the Dynamic Heat Control™ System and Premium Glass Guard, providing a completely unobstructed view of the tallest flames in the Linear Series, eliminating the need for safety screens!

Compatible with the Luxuria™ and Vector™ Series.

AWARD-WINNING SYSTEMS





DYNAMIC HEAT CONTROL™ PLUS

A powered solution that allows heat to be pulled from the fireplace enclosure and directed to any living area in the home that needs it, including outdoors when not needed inside your home. This system is as quiet as a bathroom fan. Easily install a TV above the fireplace. Uses variable speed which allows the installer to reduce the fan speed to suit the specific installation and minimize any sound.

Compatible with the Luxuria™ and Vector™ Series.

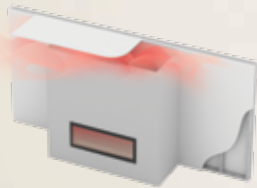

Stopping shy of the ceiling allows rising hot air to escape freely from the top of the enclosure and into the room.



Uses an air outlet opening that will be built into the front of the constructed enclosure, at the top, centered above the appliance.

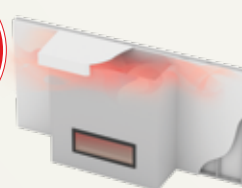

Stopping shy of the ceiling, allows rising hot air to escape freely from the top of the enclosure and into the room.



This style of enclosure includes an air outlet opening that will be built into the rear of the constructed enclosure above the appliance.



DUCTED HEAT MANAGEMENT

Offers the greatest amount of flexibility for installations with front venting, side venting and off-the-side termination. This passive heat management system requires no fans or blowers for silent operation. The temperature directly above the fireplace is drastically reduced and safely distributed, allowing for the installation of electronics or fine art directly above the fireplace without fear of heat damage. The ultimate in flexible design with true zero clearance to combustible materials.

The Ducted Heat Management System is built with termination plates and ducts. An industry-first termination plate installation offers homeowners the benefits of off-the-side venting and room divider installations, as well as providing a way to safely pass cables through the wall for ease of electronic installation.

Compatible with the Luxuria™ and Vector™ Series.

***Termination plates are for Vector™ appliances only.*

Dimensions and Specifications

Single Sided Vector™ Series

Product Code	BTU's (Input)	Venting 5" / 8"	Height		Width		Depth		Viewing Area		Efficiency
			Actual	Framing	Actual	Framing	Actual	Framing	Height	Width	P4
LV38N-1	30,000	Top	39 3/4"	40" **	53 5/16"	56 3/16"	20"	20 1/8"	18 5/8"	40 3/4"	38.4%
LV50N-2	36,000	Top	39 3/4"	40" **	65 5/16"	65 13/16"	20"	20 1/8"	18 5/8"	52 3/4"	45.4%
LV62N	42,000	Top	39 3/4"	40" **	77 5/16"	77 13/16"	20"	20 1/8"	18 5/8"	64 3/4"	52%
LV74N	48,000	Top	39 3/4"	40" **	89 5/16"	89 13/16"	20"	20 1/8"	18 5/8"	76 3/4"	52.1%

** Non-Combustible Header, Framing and Finishing Material **MAY** be required.

See Through Vector™ Series

Product Code	BTU's (Input)	Venting 5" / 8"	Height		Width		Depth		Viewing Area (per side)		Efficiency
			Actual	Framing	Actual	Framing	Actual	Framing	Height	Width	P4
LV38N2-1	30,000	Top	39 3/4"	40" **	53 5/16"	53 13/16"	16 3/16"	16 3/16"	18 5/8"	40 3/4"	38.4%
LV50N2-2	36,000	Top	39 3/4"	40" **	65 5/16"	65 13/16"	16 3/16"	16 3/16"	18 5/8"	52 3/4"	45.4%
LV62N2	42,000	Top	39 3/4"	40" **	77 5/16"	77 13/16"	16 3/16"	16 3/16"	18 5/8"	64 3/4"	52%
LV74N2	48,000	Top	39 3/4"	40" **	89 5/16"	89 13/16"	16 3/16"	16 3/16"	18 5/8"	76 3/4"	52.1%

** Non-Combustible Header, Framing and Finishing Material **MAY** be required.

Single Sided Luxuria™ Series

Product Code	BTU's (Input)	Venting 5" / 8"	Height		Width		Depth		Viewing Area		Efficiency
			Actual	Framing	Actual	Framing	Actual	Framing	Height	Width	P4
LVX38N-1	32,000	Top	39 3/4"	40"	53 5/16"	53 13/16"	17 11/16"	18"	18 5/8"	42 1/8"	39.6%
LVX50N-1	38,000	Top	39 3/4"	40"	65 5/16"	65 13/16"	17 11/16"	18"	18 5/8"	54 1/8"	45%
LVX62N-1	44,000	Top	39 3/4"	40"	77 5/16"	77 13/16"	17 11/16"	18"	18 5/8"	66 1/8"	47.4%
LVX74N-1	50,000	Top	39 3/4"	40"	89 5/16"	89 13/16"	17 11/16"	18"	18 5/8"	78 1/8"	52.1%

Dimensions and Specifications

See Through Luxuria™ Series

Product Code	BTU's (Input)	Venting 5" / 8"	Height		Width		Depth		Viewing Area (per side)		Efficiency P4
			Actual	Framing	Actual	Framing	Actual	Framing	Height	Width	
L VX38N2X-1	32,000	Top	39 3/4"	40"	53 5/16"	53 13/16"	16 3/16"	16 3/16"	18 5/8"	42 1/8"	39.6%
L VX50N2X-1	38,000	Top	39 3/4"	40"	65 5/16"	65 13/16"	16 3/16"	16 3/16"	18 5/8"	54 1/8"	45%
L VX62N2X-1	44,000	Top	39 3/4"	40"	77 5/16"	77 13/16"	16 3/16"	16 3/16"	18 5/8"	66 1/8"	47.4%
L VX74N2X-1	50,000	Top	39 3/4"	40"	89 5/16"	89 13/16"	16 3/16"	16 3/16"	18 5/8"	78 1/8"	52.1%

Ascent™ Linear Series

Product Code	BTU's (Input)	Venting 5" / 8"	Height		Width		Depth		Viewing Area		Efficiency P4
			Actual	Framing	Actual	Framing	Actual	Framing	Height	Width	
BL36-1	17,500	Top 4" / 7"	39 1/16"	39 3/8"	35 15/16"	36 1/2"	15 3/4"	16"	18 13/16"	31 9/16"	45.3 %
BL42	20,000	Top 4" / 7"	38 3/16"	39 3/8"	42"	42 1/2"	18 5/16"	18 9/16"	18 13/16"	38 1/2 "	47.1 %
BL46	24,000	Top 4" / 7"	39 1/16"	39 3/8"	46 7/8"	47 3/8"	18 5/16"	18 9/16"	18 13/16"	42 1/2 "	49.4 %
BL56	28,000	Top 5" / 8"	38 13/16"	39 3/8"	56"	56 1/2 "	18 5/16"	18 9/16"	18 13/16"	52 1/2 "	47.2 %

NAPOLEON

CELEBRATING OVER 40 YEARS OF HOME COMFORT PRODUCTS



24 Napoleon Road, Barrie, Ontario, Canada L4M 0G8
 103 Miller Drive, Crittenden, Kentucky, USA 41030
 7200 Trans Canada Highway, Montreal, Quebec, Canada H4T 1A3

Tel: 1-888-721-7253
napoleon.com

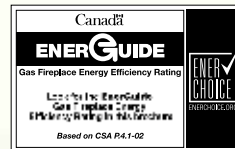

Authorized Dealer

Consult your owner's manual for complete installation instructions and proper clearances to combustible materials. Check all local and national building codes and gas regulations. All specifications are subject to change without prior notice due to on-going product improvements. Products may not be exactly as shown. Flame height and activity is influenced by varying vent configurations and may not appear as shown. Napoleon is a registered trademark of Wolf Steel Ltd. © Wolf Steel Ltd. EnerGuide - A Canadian efficiency standard based on frequent, short start-up and cool-down cycles. All appliances sold in Canada are subject to this EnerGuide rating system. AFUE - A US efficiency standard (Department of Energy) based on extended on/off cycles, more typical of fireplace usage. Steady State - Reflects the highest possible overall heating efficiency.

NAPOLEON

OUTDOOR GAS FIREPLACES | GAS PATIOFLAME® | PATIOFLAME® TABLES



napoleonproducts.com



Designed to take the stress out of everyday life.

Galaxy™ - GSS48 & GSS48ST.....	4 - 5
Riverside™ 42 Clean Face - GSS42CF	6 - 7
Riverside™ 36 - GSS36CF	8 - 9
Riverside Torch™ - GSST8	10 - 11
Linear Patioflame® - GPFL48MHP	12 - 13
Patioflame® - GPF & GPFG	14 - 15
Kensington Series Patioflame® Tables.....	16 - 17
St. Tropez Series Patioflame® Tables	18 - 19
Hamptons Series Patioflame® Tables	20 - 21
Victorian Patioflame® Tables	22 - 23
Muskoka Series Patioflame® Tables.....	24 - 25
Built-in Burner Kits	26 - 27



The St. Tropez Square Patioflame® Tables



FIND YOUR HAPPY (fire)PLACE.

Throughout the ages, people have gathered around fires to share in life's greatest joys.

There's just something about the glow of flickering flames that makes special moments feel even warmer.

Napoleon fireplaces and Patioflames® are uniquely designed to brighten the vibe of your home. Napoleon has an incredible range of designer options to fit any vision.

A fire not only raises the warmth and ambiance, it can raise the value of your home. A fireplace offers some of the highest returns of any remodeling project, and that should make you feel good all over.

So that you can keep enjoying the positive glow for years and years and years to come, every Napoleon fireplace is backed by the President's Limited Lifetime Warranty.



Napoleon's Hot Spots Research Study delivers insights on key areas of the home. In particular, how to help you add relaxation, social interaction and functionality to rooms to enhance your memorable moments.

Throughout this brochure we will share some of our insights with you.

For more inspiration visit napoleonfireplaces.com/inspiration



We are proud to be recognized as one of Canada's Best Managed Companies and are dedicated to providing quality, home comfort products for over 40 years and counting.

Galaxy™

Out of this World

Napoleon's Galaxy™ outdoor linear gas fireplace is constructed of weather resistant brushed stainless steel for maximum outdoor durability and is available in single sided (GSS48) and See Thru (GSS48ST) models. The galaxy features an "easy start" ignitor, a glass wind deflector (two included with See Thru unit) to ensure operation in windy conditions as well as a safety valve that turns the gas supply off if the flame goes out. With all these this outdoor linear gas fireplace is the perfect addition to any backyard oasis.

Galaxy™ - GSS48
 55,000 BTU's
 16 ½"h x 47 ½"w x 17 ⅝"d
 Natural gas or propane

Galaxy™ See-Thru - GSS48ST
 55,000 BTU's
 16 ½"h x 47 ½"w x 21 ⅝"d
 Natural gas or propane

Options & Accessories



Fireplace Cover
 Brushed Stainless Steel
 (optional)



Driftwood Media Kit
 (log set and six river rocks included)
 (optional)



Four-Sided Trim Kit
 Brushed Stainless Steel Finish
 (optional)



LED Light Strip & Glass Wind Deflector(s)
 LED lights transition through an array of colors based on an RGB color spectrum accenting the glass wind deflector (two with two-sided unit) (included)



The Galaxy™ shown in a custom built-in stainless steel application



Outdoor Fireplaces represent one of the strongest desires among respondents for their next home.





The Galaxy™ See Thru shown with optional four-sided trim kit and accent light set on blue



Optional Glass Media Kits
Blue, Amber, Black, Red, Clear and Topaz (included)



Optional River Rock Media Kits
Multi-Colored or Grey Finishes

Model	Dimensions			Glass Type	Ember Bed	Controls	Ignition	Warranty
	Height	Front Width	Depth					
GSS48	16 1/2"	47 1/2"	17 5/16"	Tempered	CRYSTALINE™	On/Off, High/Low & Accent Lights	"Easy Start"	Five Year
GSS48ST	16 1/2"	47 1/2"	21 1/8"	Tempered	CRYSTALINE™	On/Off, High/Low & Accent Lights	"Easy Start"	Five Year

Consult your owner's manual for complete and up-to-date measurements and installation instructions for proper clearances to combustible materials.

Riverside™ 42 Clean Face

Warm and Welcoming

Create a breathtaking focal point in your backyard with this outdoor gas fireplace. Napoleon's Riverside™ 42 Clean Face fireplace is weather resistant due to its 100% stainless steel construction for maximum durability. Featuring Napoleon's exclusive PHAZER® log set and stainless steel clean face surround, you are bound to enjoy an unobstructed view of the beautiful flames. Let your imagination flow with endless possibilities - no venting or chimney requirements means installation is simple and easy.

Riverside™ 42 Clean Face - GSS42CF

Up to 65,000 BTU's

Flame/heat adjustment

35 5/8"h x 46 1 1/4"w x 23"d

Natural gas or propane

Options & Accessories



Seasonal Protective Cover
(Optional)



PHAZER® log set and embers
(Included)



Remote Control
F45 - On/Off
(Optional)



The Riverside™ 42 Clean Face shown with decorative sandstone brick panels



Exposing home buyers to great outdoor designs increases desire for a fireplace by **577%** according to Napoleon's Hot Spots Research Study.





The Riverside™ 42 Clean Face



Optional Decorative Sandstone Brick

Model	Dimensions			Glass Type	Log Set	Controls	Ignition	Warranty
	Height	Front Width	Depth					
GSS42CF	35 3/4"	46 5/8"	21 1/8"	Tempered	PHAZER™	Flame/Heat	Push Button	Five Year

Consult your owner's manual for complete and up-to-date measurements and installation instructions for proper clearances to combustible materials.

Riverside™ 36 Clean Face

Light My Fire

Napoleon's new Riverside™ 36 Clean Face is a beautiful and modern outdoor gas fireplace. Designed with 100% high quality stainless steel construction, the Riverside™ 36 Clean Face is tough enough to withstand the harshest outdoor environments. Unique to the outdoor fireplace category, this fireplace can be burned and enjoyed with the optional door kit closed. Boasting not one, but two impressive premium log set designs - your choice of Birch or Oak, you are sure to fall in love with your new outdoor gas fireplace. Tell your kitchen to move aside, your backyard is about to become your new social gathering hot spot for family and friends.

Riverside™ 36 Clean Face- GSS36CF

Up to 40,000 BTU's

Flame/heat adjustment

35 5/8"h x 42"w x 20 3/8"d

Natural gas or propane



The Riverside™ 36 shown with Westminster Grey decorative brick panels.



Options & Accessories



Birch Log Set



Oak Log Set



Stainless Steel Seasonal Cover
(optional)



Stainless Steel Traditional
Door Kit
(optional)



Stainless Steel Safety Screen
(optional)



Remote Control
F45 - On/Off
(optional)



The Riverside™ 36 shown with stainless steel safety screen and Old Town Red™ decorative brick panels.



Optional Westminister Grey
Decorative Brick Panels

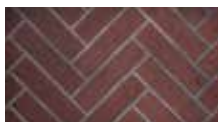

Optional Old Town Red™
Decorative Brick Panels

Model	Dimensions			Glass Type	Log Set	Controls	Ignition	Warranty
	Height	Front Width	Depth					
GSS36CF	39 9/16"	42"	20 3/16"	Tempered on Door Kit	PHAZER™	Flame/Heat	Push Button	Five Year

Consult your owner's manual for complete and up-to-date measurements and installation instructions for proper clearances to combustible materials.

Riverside Torch®

Cutting Edge Slim Design

The Riverside Torch® Features a cutting edge slim design, towering single flame, MIRRO-FLAME™ Porcelain Reflective Radiant Panels and fuel saving electronic ignition that make this outdoor fireplace perfect for residential or commercial installations. Constructed from durable stainless steel, powder coated and porcelain materials that stand up to the toughest outdoor environments. The ideal accent piece for entrance ways, gardens, patios and outdoor rooms.

Riverside Torch® - GSST8
 6,000 BTU's
 49 1/16"h x 15"w x 7 7/16"d
 Natural gas or propane



The Riverside Torch® flame pattern



Options & Accessories



Frame & Cabinet
 Brushed Stainless Steel
 (included)



Upper/Lower Accent Lights
 Four Lights Included
 (optional)



Convenient On/Off and Accent
 Light Switches
 (included)



The Riverside Torch[®] shown with standard brushed stainless steel frame and cabinet



MIRRO-FLAME[®] Porcelain Reflective Radiant Panels (included)

Model	Dimensions			Glass Type	Controls	Ignition	Warranty
	Height	Front Width	Depth				
GSST8	49 11/16"	15"	7 9/16"	Tempered	On/Off & Accent Lights	Electronic	Five Year

Consult your owner's manual for complete and up-to-date measurements and installation instructions for proper clearances to combustibles materials.

Linear Patioflame®

Ribbon of Fire

The Linear Patioflame® comes complete with a Hammertone pewter powder coated cabinet and exclusive Topaz CRYSTALINE™ ember bed. The convenient piano hinged door allows easy access to the control panel and features a safety valve that turns off the gas if the flame goes out. The burner, burner chassis and convenient cover plate, complete with handle, are made from durable weather resistant brushed stainless steel. A truly unique outdoor fire pit with a slim, sleek modern design, adding to the excitement of outdoor living.

Linear Patioflame® - GPFL48MHP

60,000 BTU's

11 7/8" h x 51 7/8" w x 17 7/8" d

Natural gas or propane



The Linear Patioflame® shown with standard Topaz CRYSTALINE™ ember bed and windscreen

Options & Accessories



Brushed Stainless Steel Cover*
and Hammertone Pewter Cabinet
(included)



Glass Wind Deflector
(optional)

* Cover is not for use with optional rock media kits.





The Linear Patioflame® shown with standard Topaz CRYSTALINE® ember bed



Optional Glass Media Kits
Blue, Amber, Black, Red, Clear, Topaz (included)



Optional River Rock Media Kits
Multi-Colored or Grey Finishes

Model	Dimensions			Ember Bed	Controls	Ignition	Warranty
	Height	Front Width	Depth				
GPFL48MHP	11 7/8"	51 7/8"	17 7/8"	CRYSTALINE®	On/Off, High/Low	"Easy Start"	Five Year

Consult your owner's manual for complete and up-to-date measurements and installation instructions for proper clearances to combustible materials.

Patioflame® & Patioflame® Glass

Flickering Glow

There is nothing more enjoyable than spending time outdoors with family and friends. The Patioflame® & Patioflame® Glass allows you to extend your outdoor season whether it be at the cottage, camping or in your backyard. The burner is constructed from all stainless steel for maximum outdoor durability and weather resistance. The Patioflame® & Patioflame® Glass easily installs anywhere and keeps the outdoor chill away while friends and family gather well into the evening. Perfect for use on wooden decks, stone or brick patios and concrete.

Patioflame® Logs - GPF
60,000 BTU's
18"h (to logs) x 20" diameter
Natural gas or propane

Patioflame® Glass - GPFG
60,000 BTU's
4 ¾"h x 20" diameter
Natural gas or propane



The Gas Patioflame® shown with GLOCAST® Log Set (GPF) and optional safety screen

Options & Accessories



Safety Screen
(optional)



Cover
(optional)



Table and Black Granite Top
(optional)





The Gas Patioflame® shown with Topaz CRYSTALINE™ Ember Bed (GPFG)



Optional Glass Media Kits
Blue, Amber, Black, Red, Clear, Topaz (included with GPFG)



Optional River Rock Media Kits
Multi-Colored or Grey Finishes

Name	Model	Dimensions		Ember Bed	Controls	Warranty
		Height	Length			
Patioflame®	GPF	18"	20" dia.	GLOCAST® Log Set	On/Off	Five Year
Patioflame® Glass	GPFG	4 3/4"	20" dia.	CRYSTALINE®	On/Off	Five Year

Consult your owner's manual for complete and up-to-date measurements and installation instructions for proper clearances to combustible materials.

Kensington Patioflame® Table Series

Imperial luxury

Gather around with your family and friends beside the warm radiant heat of Napoleon's Kensington outdoor gas Patioflame® table series. The Kensington Series is constructed of hand-crafted cast aluminum for lightweight mobility and corrosion resistance. The rustic bronze finish and ornate details provide a feeling of imperial luxury in your own backyard. Each model features a topaz glass ember bed for beautiful flame reflections and colored glass is available for further customization. A single panel door provides easy access to a propane tank and a natural gas conversion kit is included for your convenience. Comes complete with matching burner cover to transform your fire table into a functional table for all your entertaining needs.

Kensington Rectangle
KENS1-BZ
60,000 BTU's
24"h x 55 1/4"w x 35 13/16"d
Natural gas or propane

Kensington Square
KENS2-BZ
60,000 BTU's
24"h x 47 5/8"w x 47 5/8"d
Natural gas or propane

Kensington Round
KENS3-BZ
40,000 BTU's
24"h x 47 5/8" dia.
Natural gas or propane

Options & Accessories



61851



61850



61855

UV Protected Fitted Covers



Windscreen Rectangle | GPFR-WNDSCRN



Windscreen Square | GPFS-WNDSCRN



Windscreen Round | GPFCE-WNDSCRN



Rectangle



Square



Round





The Kensington Square Patioflame® Table



Optional Glass Media Kits
Blue, Amber, Black, Red, Clear and Topaz (included)

Name	Model	Overall Dimensions			Ember Bed	Controls	Ignition	Warranty
		Height	Width	Depth				
Kensington Rectangle	KENS1-BZ	24"	55 1/4"	35 13/16"	Topaz glass	On/Off, High/Low	"Easy Start" Electronic	3 Year Limited
Kensington Square	KENS2-BZ	24"	47 5/8"	47 5/8"	Topaz glass	On/Off, High/Low	"Easy Start" Electronic	3 Year Limited
Kensington Round	KENS3-BZ	24"	47 5/8" diameter		Topaz glass	On/Off, High/Low	"Easy Start" Electronic	3 Year Limited

Consult your owner's manual for complete and up-to-date measurements and installation instructions for proper clearances to combustible materials.

St. Tropez Patioflame® Table Series

Reminisce about the Riviera

Napoleon's St. Tropez outdoor gas Patioflame® table series features a classic, linear design that will match any outdoor décor and take the chill off cool evenings. The St. Tropez Series is constructed of rust-free aluminum for lightweight mobility and corrosion resistance. A stylish topaz glass ember bed reflects the light of the flames warming you and providing a cozy atmosphere. The single panel access door opens to the propane tank for easy tank replacement and a natural gas conversion kit is included for your convenience. Comes with a matching burner cover to provide a larger serving area for entertaining, when not burning.

St. Tropez Rectangle

STTR1-BZ

60,000 BTU's

24"h x 36 1/4"w x 56 11/16"d

Natural gas or propane

St. Tropez Square

STTR2-BZ

60,000 BTU's

24"h x 49 1/4"w x 49 1/4"d

Natural gas or propane

Options & Accessories



61851



61850

UV Protected Fitted Covers



Wind Screen Rectangle | GPFR-WNDSCRN



Wind Screen Square | GPFS-WNDSCRN



Rectangle



Square





The St. Tropez Square Patioflame® Table



Optional Glass Media Kits
Blue, Amber, Black, Red, Clear and Topaz (included)

Name	Model	Overall Dimensions			Ember Bed	Controls	Ignition	Warranty
		Height	Width	Depth				
St. Tropez Rectangle	STTR1-BZ	25"	36 1/4"	56 11/16"	Topaz glass	On/Off, High/Low	"Easy Start" Electronic	3 Year Limited
St. Tropez Square	STTR2-BZ	54"	49 1/4"	49 1/4"	Topaz glass	On/Off, High/Low	"Easy Start" Electronic	3 Year Limited

Consult your owner's manual for complete and up-to-date measurements and installation instructions for proper clearances to combustible materials.

Hamptons Patioflame® Table Series

Modern elegance

A stylish, contemporary design sets the Napoleon Hamptons Series Patioflame® Tables apart from the rest. The beachy – casual construction, and grey color match any décor. Safe and fuel efficient, the Hamptons Series features a thermocouple valve that cuts the gas when flame is interrupted, meaning that if a gust blows the flame out, or you forget to shut the gas when you're done, no gas will be wasted. The beautifully constructed, durable, aluminum surround conveniently hides a gas tank (propane models). Never worry about the weather, drainage holes in the burner pan allow the rain to drain away, and the optional windscreen will protect the flames from the wind. Set your drinks down, converse in comfort and enjoy your outdoor living space. Easily convert your Hamptons Patioflame® Table into a fully functioning table with the included matching cover.

Hamptons Rectangle

HAMP1-GY

40,000 BTU's

25 3/8"h x 52 1/8"w x 32 1/8"d

Natural gas or propane

Hamptons Square

HAMP2-GY

40,000 BTU's

25 3/8"h x 41 3/4"w x 41 3/4"d

Natural gas or propane



Rectangle - Grey



Square - Grey

Options & Accessories



61853



61852

UV Protected Fitted Covers



Wind Screen Rectangle | GPFRE-WNDSCRN



Wind Screen Square | GPFSE-WNDSCRN



The Hamptons Rectangle Patioflame® Table



Optional Glass Media Kits
Blue, Amber, Black, Red, Clear and Topaz (included)

Name	Model	Overall Dimensions			Ember Bed	Controls	Ignition	Warranty
		Height	Width	Depth				
Hamptons Rectangle	HAMP1-GY	25 3/16"	52 1/16"	32 1/16"	Topaz glass	On/Off, High/Low	"Easy Start" Electronic	3 Year Limited
Hamptons Square	HAMP2-GY	25 3/16"	41 3/4"	41 3/4"	Topaz glass	On/Off, High/Low	"Easy Start" Electronic	3 Year Limited

Consult your owner's manual for complete and up-to-date measurements and installation instructions for proper clearances to combustible materials.

Victorian Patioflame® Table Series

Refined beauty

Classic and elegant, the Napoleon Victorian Rectangular Patioflame® Table is the anchor for your outdoor living space. Gather round and relax with a beautiful ribbon of dancing flame. Safe and fuel efficient, the Victorian Rectangular Patioflame® Table features a Thermocouple valve that cuts the gas when flame is interrupted, meaning that if a gust blows the flame out, or you forget to shut the gas when you're done, no gas will be wasted. The beautifully constructed, durable, aluminum surround conveniently hides a gas tank (propane models). Never worry about the weather, drainage holes in the burner pan allow the rain to drain away, and the optional Wind Screen kit will protect the flames from the wind. Set your drinks down, converse in comfort and enjoy your outdoor living space. Bask in the glow and warmth from the refined beauty of the Victorian Rectangular Patioflame® Table.

Victorian Rectangle

VICT1-BZ

60,000 BTU's

25 3/8"h x 52 3/8"w x 31 7/8"d

Natural gas or propane

Victorian Square

VICT2-BZ

60,000 BTU's

25 3/8"h x 41 1/16"w x 41 1/16"d

Natural gas or propane

Victorian Round

VICT3-BZ

40,000 BTU's

25 3/8"h x 41 3/8" dia.

Natural gas or propane



Rectangle



Square



Round

Options & Accessories



61851



61850



61854

UV Protected Fitted Covers



Windscreen Rectangle | GPFTR-WNDSCRN



Windscreen Square | GPFTR-WNDSCRN



Windscreen Round | GPFCE-WNDSCRN





The Victorian Round Patioflame® Table



Optional Glass Media Kits
Blue, Amber, Black, Red, Clear and Topaz (included)

Name	Model	Overall Dimensions			Ember Bed	Controls	Ignition	Warranty
		Height	Width	Depth				
Victorian Rectangle	VICT1-BZ	25 3/8"	52 3/8"	31 7/8"	Topaz glass	On/Off, High/Low	"Easy Start" Electronic	3 Year Limited
Victorian Square	VICT2-BZ	25 3/8"	41 1/8"	41 1/8"	Topaz glass	On/Off, High/Low	"Easy Start" Electronic	3 Year Limited
Victorian Round	VICT3-BZ	25 3/8"	41 3/8" diameter		Topaz glass	On/Off, High/Low	"Easy Start" Electronic	3 Year Limited

Consult your owner's manual for complete and up-to-date measurements and installation instructions for proper clearances to combustible materials.

Muskoka Patioflame® Table Series

Cottage Lifestyle

Feel the ambiance of cottage life while enjoying the warmth of an open fire with the Napoleon Muskoka Patioflame® Table Series. Coming in both square and rectangular shapes, the cast aluminum frames make these tables lightweight, and along with the all stainless steel burner construction, incredibly durable. Never worry about the weather, drainage holes in the stainless steel burner pan allow the rain to drain away, and the optional Windscreen kit protects the flames. Safe and fuel efficient, the Muskoka Patioflame® Table Series features a Thermocouple valve that cuts the gas when the flames are interrupted by wind, or if the gas is left on. Embrace the cottage lifestyle.

Muskoka Rectangle

MUSK1-BZ

60,000 BTU's

24 5/8"h x 36 1/4"w x 56 11/16"d

Natural gas or propane

Muskoka Square

MUSK2-BZ

60,000 BTU's

24 5/8"h x 49 3/16"w x 49 3/16"d

Natural gas or propane



Rectangle



Square

Options & Accessories



61853



61852

UV Protected Fitted Covers



Windscreen Rectangle | GPFR-WNDSCRN



Windscreen Square | GPFS-WNDSCRN





The Muskoka Rectangle Patioflame® Table



Optional Glass Media Kits
Blue, Amber, Black, Red, Clear and Topaz (included)

Name	Model	Overall Dimensions			Ember Bed	Controls	Ignition	Warranty
		Height	Width	Depth				
Muskoka Rectangle	MUSK1-BZ	24 5/8"	36 1/4"	56 11/16"	Topaz glass	On/Off, High/Low	"Easy Start" Electronic	3 Year Limited
Muskoka Square	MUSK2-BZ	24 5/8"	49 3/16"	49 3/16"	Topaz glass	On/Off, High/Low	"Easy Start" Electronic	3 Year Limited

Consult your owner's manual for complete and up-to-date measurements and installation instructions for proper clearances to combustible materials.

Stainless Steel Built-in Burner Kits

Design your dream outdoor fire display

Perfect your space with Napoleon's Patioflame® Burner Kits. These unique kits allow you to install a gas burning fire pit into a noncombustible base that suits your outdoor living area. A modern work of art, the Patioflame® Burner Kits produce rippling flames that flow from multiple burner ports for the most realistic display. Bring the excitement of a custom outdoor fire pit to your home with Napoleon's Patioflame® Burner Kit to experience the ambiance only the glow of a fire can provide. Your backyard oasis isn't complete without one.

Linear Burner Kit
GPFL48

60,000 BTU's
5 1/2"h x 47 1/2"w x 13 1/2"d
Natural gas or propane

Rectangle Burner Kit
GPFR60

60,000 BTU's
2 1/4"h x 33 1/4"w x 11 3/4"d
Natural gas or propane

Square Burner Kit
GPFS60

60,000 BTU's
2 1/2"h x 25 3/4"w x 25 3/4"d
Natural gas or propane



Optional Glass Media Kits
Blue, Amber, Black, Red, Clear and Topaz (included)

Name	Model	Overall Dimensions			Ember Bed	Controls	Ignition	Warranty
		Height	Width	Depth				
Linear Burner Kit	GPFL48	5 1/2"	47 1/2"	13 1/2"	Topaz glass	On/Off, High/Low	"Easy Start" Electronic	5 Year Limited
Rectangle Burner Kit	GPFR60	2 1/4"	33 1/4"	11 3/4"	Topaz glass	On/Off, High/Low	"Easy Start" Electronic	3 Year Limited
Square Burner Kit	GPFS60	2 1/2"	25 3/4"	25 3/4"	Topaz glass	On/Off, High/Low	"Easy Start" Electronic	3 Year Limited

Consult your owner's manual for complete and up-to-date measurements and installation instructions for proper clearances to combustible materials.



Linear Burner Kit - GPFL48



Rectangle Burner Kit - GPFR60



Square Burner Kit - GPFS60





The Linear Burner Kit in a custom install application with Topaz ember bed



NAPOLEON - CELEBRATING OVER 40 YEARS OF HOME COMFORT PRODUCTS



24 Napoleon Road, Barrie, Ontario, Canada L4M 0G8
103 Miller Drive, Crittenden, Kentucky, USA 41030
7200 Trans Canada Highway, Montreal, Quebec, Canada H4T 1A3

Tel: 1-866-820-8686
napoleonfireplaces.com



Authorized Dealer

Consult your owner's manual for complete installation instructions and proper clearances to combustible materials. Check all local and national building codes and gas regulations. All specifications are subject to change without prior notice due to on-going product improvements. Products may not be exactly as shown. Flame height and activity is influenced by varying vent configurations and may not appear as shown. Napoleon is a registered trademark of Wolf Steel Group Inc. Certified to ANSI Z21.97-2012 / CSA 2.41-2012, OUTDOOR DECORATIVE GAS APPLIANCE STANDARD

Printed in Canada
ABBROUT 06/2018

NAPOLEON



VENT FREE FIREPLACES, STOVES & GAS LOGS
napoleonfireplaces.com



All the features of a direct vent fireplace... without the venting

Torch™ - GVFT8	4 - 5
Plazmafire™ - WHVF24	6 - 7
Plazmafire™ - WHVF31	6 - 7
GVF36	8 - 9
GVF42	10 - 11
Arlington™ - GVFS20	12 - 13
GVFS60	14 - 15
GVFL18, GVFL24, GVFL30, ZCVF36 & ZCVF42	16 - 17
Napoleon's Outstanding Features	18 - 19
Options & Accessories	20 - 21
Detailed Specifications	22 - 23



GVFS60 shown in painted metallic black finish with a painted black trivet



FIND YOUR HAPPY (fire)PLACE.

Throughout the ages, people have gathered around fires to share in life's greatest joys.

There's just something about the glow of flickering flames that makes special moments feel even warmer.

A Napoleon fireplace is uniquely designed to brighten the vibe of any room in your house. Napoleon has an incredible range of designer options to fit any vision.

A fire not only raises the warmth and ambiance of a room, it can raise the value of your home. A fireplace offers some of the highest returns of any remodeling project. And that should make you feel good all over.

And so you can keep enjoying that positive glow for years and years and years to come, every Napoleon fireplace is backed by the President's Limited Lifetime Warranty.



We are proud to be recognized as one of Canada's Best Managed Companies and are dedicated to providing quality, home comfort products for over 40 years and counting.

Torch™ - GVFT8

Slim Modern Design

An ultra modern vent free fireplace with a slim design featuring a reflective, prism shaped firebox. Napoleon's Torch™ features decorative glass embers, heat resistant glass and MIRRO-FLAME™ Porcelain Reflective Radiant Panels. Ideal for new construction and renovation projects, the Torch™ can be installed in hallways, entranceways, bathrooms, bedrooms, offices and spas.

Torch™
6,000 BTU's
15"w x 49 1/16"h with mounting cabinet
Natural gas or propane

For more detailed specifications on this unit, see page 21

Options & Accessories



Frames/Fronts
Three Finish Options*



LED Accent Light Kit
Four Lights Included



Adjustable Mounting Cabinets
Two Finish Options*



The Torch™ shown with brushed stainless steel frame and mounting cabinet





The Torch™ shown with brushed stainless steel frame and painted metallic black mounting cabinet



MIRRO-FLAME™
Porcelain Reflective
Radiant Panels
(included with unit)



Plazmafire™ - WHVF24 & WHVF31

Easy Installation

Ideal for modern and contemporary rooms, the Plazmafire™ comes with a Topaz CRYSTALINE™ ember bed. Napoleon's Plazmafire™ features easy installation plus all of the conveniences of a vent free gas fireplace. Virtually endless installation possibilities, it's almost as easy as hanging a picture on the wall. Catalytic tiles are included and perform as a "filter" reducing and removing combustion by-products. The Plazmafire™ 24 comes with a curved glass front and the Plazmafire™ 31 offers optional surrounds making it a great addition and focal point to any room.

Plazmafire™ 24

Up to 9,000 BTU's

50% flame/heat adjustment

32 3/8" w x 22" h

Natural gas or propane

Plazmafire™ 31

Up to 20,000 BTU's

43 5/16" w x 28" h

Natural gas or propane

For more detailed specifications on this unit, see page 21

Options & Accessories



Convex Surround
Brushed Stainless Steel Finish
(for Plazmafire™ 31 only)



Safety Screen
(for Plazmafire™ 31 only)



LED Light Kit
Two Lights Included
(for Plazmafire™ 31 only)



Rectangular Surrounds
Two Color Options*
(for Plazmafire™ 31 only)



F45 & F60 Remote Controls
On/off with Digital Screen
(for Plazmafire™ 31 only)



Catalytic Filtering Tiles



The Plazmafire™ 24 shown with included curved glass front





The PlazmafIRE™ 31 shown with rectangular surround in painted black finish



Slate Brick Panel
(included with
PlazmafIRE™ 31)

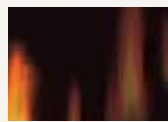

MIRRO-FLAME™
Porcelain Reflective
Radiant Panels (included
with PlazmafIRE™ 24)



Alternate Glass Media Kits & Glass Enhancement Kits
Blue, Amber, Black, Red and Clear



GVF36 - 36" Fireplace

A Multitude of Different Looks

With a multitude of designer options and a room warming 30,000 BTU's, it's no wonder the GVF36 is one of the best selling vent free fireplaces in North America. Complete with Napoleon's PHAZER® logs and advanced burner technology, the GVF36 produces beautiful YELLOW DANCING FLAMES®. The GVF36 provides cutting-edge, vent free technology with many designer options to suit your style.

GVF36

Up to 30,000 BTU's

50% flame/heat adjustment

37 3/8" w x 35 1/2" h

Natural gas or propane

For more detailed specifications on this unit, see page 22

Options & Accessories



3" Bevelled Trim Kits
Two Color Options*



6" Bevelled Trim Kit
Textured Painted Black

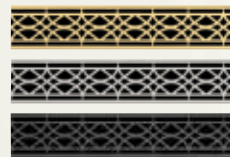

Ornamental Insets
Three Color Options*



Louvers
Three Color Options*



Cast Iron Surrounds
Painted Black Finish



F45 & F60 Remote Controls
On/off with Digital Screen



Andirons
Painted Black Finish



Fireplace screen





GVF36 shown with painted black louvers



Decorative Sandstone
Brick Panels



MIRRO-FLAME
Porcelain Reflective
Radiant Panels



GVF42 - 42" Fireplace

Massive Viewing Area

A stunning 42" vent free fireplace that features a multi-level burner with realistic PHAZER® logs creating a beautiful display of YELLOW DANCING FLAMES® that fill the firebox. With the easy installation of vent free technology and the optional decorative accessories, the GVF42 efficiently transforms a room into a relaxing, warm oasis with a beautiful fireplace as the focal point.

GVF42

Up to 30,000 BTU's

50% flame/heat adjustment

42" w x 38 1/2" h

Natural gas or propane

For more detailed specifications on this unit, see page 22

Options & Accessories



Louvers
Two Color Options*



F45 & F60 Remote Controls
On/off with Digital Screen



Andirons
Painted Black Finish



GVF42 shown with painted black louvers and MIRRO-FLAME Panels





GVF42 shown with brushed stainless steel louvers and MIRRO-FLAME[®] Porcelain Reflective Radiant Panels



Decorative Sandstone
Brick Panels



MIRRO-FLAME[®]
Porcelain Reflective
Radiant Panels



Arlington™ - GVFS20

Good Things Come in Small Packages

The vent free Arlington™ gas stove, although compact in size, makes a powerful statement in any room. This Early American cast iron design features exquisite detail and styling that is complimentary to a wide variety of rooms. The Arlington™ features Napoleon's advanced burner system with flame/heat adjustment and a MIRRO-FLAME™ Porcelain Reflective Radiant Panel.

Arlington™

Up to 23,000 BTU's

50% flame/heat adjustment

19 1/4" w x 25 3/8" h as shown

Natural gas or propane

For more detailed specifications on this unit, see page 22

Options & Accessories



F45 & F60 Remote Controls
On/off with Digital Screen





The Arlington™ shown with MIRRO-FLAME® Porcelain Reflective Radiant Panels

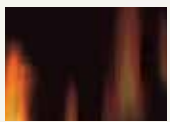

MIRRO-FLAME®
Porcelain Reflective
Radiant Panel
(included with unit)



GVFS60 - Gas Stove

Solid Performance, Impressive Heating

The GVFS60 is known for its solid performance and impressive heating efficiencies. With its elegant fine detailing and sleek, sophisticated outer casting design, the GVFS60 offers more than just great performance. The GVFS60 is available in porcelain enamel Majolica brown and painted metallic black finishes offering you a choice to match your room décor.

GVFS60

Up to 30,000 BTU's

50% flame/heat adjustment

27" w x 30 1/2" h as shown

Natural gas or propane

For more detailed specifications on this unit, see page 23

Options & Accessories



Cast Iron Trivet
Painted Black Finish
(included with unit)



Stove Finishes
Two Color Options*



Andirons
Painted Black Finish



F45 & F60 Remote Controls
On/off with Digital Screen



Solid cast iron, European design in porcelain enamel Majolica brown finish





GVFS60 shown in painted metallic black finish with a painted black trivet



Decorative Sandstone
Brick Panels



FIBERGLOW™ Vent Free Gas Log Sets

Endless Design Possibilities

The exclusive PHAZER® logs, crafted from ceramic fibers, together with Napoleon's advanced burner system provide an excellent additional heat source with a real wood fire appearance. Napoleon's vent free gas log sets are available in three sizes, 18", 24" and 30" and come complete with a cast iron grate, painted black andirons and lava rocks/cinders.

FIBERGLOW™ - 18"

Up to 40,000 BTU's
50% flame/heat adjustment
18"h x 24"w x 14"d
Natural gas or propane

FIBERGLOW™ - 24"

Up to 40,000 BTU's
50% flame/heat adjustment
18" x 28"w x 14"d
Natural gas or propane

FIBERGLOW™ - 30"

Up to 40,000 BTU's
50% flame/heat adjustment
18" x 34"w x 14"d
Natural gas or propane

For more detailed specifications on these units, see page 23

Options & Accessories



18"



24"



30"



F45 & F60 Remote Controls
On/off with Digital Screen



Zero Clearance Firebox
with Fireplace Screen
Available in 36" & 42"



Cobblestone Brick Kit
(for zero clearance firebox)



Lava Rocks / Cinders
(included with log sets)



ZCVF36 zero clearance firebox, cobblestone brick kit and the FIBERGLOW™ 24" log set





The FIBERGLOW® 30" log set shown with lava rocks and cinders



Outstanding Features

of Napoleon's Advanced Technology



Advanced Burner Technology

Napoleon's sophisticated burner system offers superior flame technology. Strategically placed burner ports create the most realistic flames in the industry.

Finely Tuned Precision Valves

Surrounded with a protective cast aluminum jacket, the precision valves allow for ultimate reliability and 100% SAFE GUARD[®] gas control system. All models come complete with an Oxygen Depletion Sensor (ODS) for your piece of mind.

No Power? No Problem!

No electricity required to light or operate. Reliable heat even during power failures.

Exclusive PHAZER[®] Logs

Napoleon's exclusive PHAZER[®] logs create a natural wood fire appearance.

Heat Circulating Blower System

The extreme heat resistant "H" class bearings featured in Napoleon's superior heat circulating blower, creates a lasting "whole home" comfort with adjustable high & low speeds.

Decorative Panels



Decorative Sandstone Brick



MIRRO-FLAME[™]
Porcelain Reflective Radiant Panels



Slate Brick Panel
(included on WHVF31)

Louvers



Polished Brass Finish



Brushed Stainless Steel Finish



Painted Black Finish

Ornamental Insets



24 Karat Gold Plated Finish



Brushed Stainless Steel Finish



Painted Black Finish

Stove Finishes



Painted Metallic
Black Finish



Porcelain Enamel
Majolica Brown Finish

Cast Iron Trivets

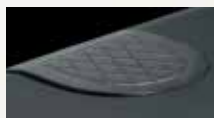

Painted Black Finish

Andirons

Designed to stand in front of the logs and give the optimum traditional masonry look and feel. They fit directly in a bay window, bay front kit or rest inside the firebox.



Convenient Remote Controls

Napoleon's remotes with digital control give you the comfort level you need at the touch of a button.



Cast Iron Surrounds



Painted Black Finish

Bevelled Trim Kits



Brushed Stainless
Steel Finish
Available in 3"



Textured Painted
Black Finish
Available in 3" or 6"



Cobblestone Brick Kit

Included with Napoleon's Zero Clearance fireboxes, ZCVF36 & ZCVF42 to add to the real wood fire appearance.



LED Accent Light Kit

Optional accents lights are available for Napoleon's vent free Torch[™] and Plazmafire[™] to enhance your surrounding décor and double as an exclusive NIGHT LIGHT.



Safety Screen

Safety screens are available to protect children, pets and visitors against inadvertent contact with glass. Glass and unit temperature can get very hot.

Lava Rocks / Cinders

Designed for placement around the logs to enhance the look and feel of Napoleon's vent free gas log sets.

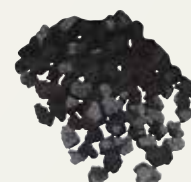

Options & Accessories to Customize Your Fireplace

Fronts & Frames



Decorative Frame
Diamond Dust
Pewter Finish



Decorative Frame
Brushed Stainless
Steel Finish



Decorative Frame
Painted Metallic
Black Finish



Mounting Cabinet
Brushed Stainless
Steel Finish



Mounting Cabinet
Painted Metallic
Black Finish



Rectangular Surround
Diamond Dust Pewter Finish



Rectangular Surround
Painted Black Finish



Convex Surround
Brushed Stainless Steel Finish

Louvers (antique brass, brushed stainless steel and painted black finishes)

Ornamental Insets (painted black, 24 Karat gold plated and satin chrome finishes)

3" Bevelled Trim (brushed stainless steel and textured painted black finishes)

6" Bevelled Trim (textured painted black finishes)

Fronts & Frames (diamond dust pewter, brushed stainless steel and painted metallic black finishes)

Mounting Cabinets (brushed stainless steel and painted metallic black finishes)

Stove Top Insets (lorena slate and ubatuba green)

Cast Iron Surround Kit (painted black finishes)

Rectangular Surrounds (painted black and diamond dust pewter finishes)

Convex Surround (brushed stainless steel finish)

MIRRO-FLAME® Porcelain Reflective Radiant Panels

Decorative Sandstone Brick Panels

Traditional Andirons (painted black finish)

LED Accent Lights

Cobblestone Brick Kit

Safety Screen

Fireplace Screen

Heat Circulating Blower Kit

Millivolt Wall Thermostat

Electronic Ignition

Oxygen Depletion Sensor (ODS)

Pre-wired For Wall Switch

On/off Remote with Digital Screen

	GVF18	WHVF24	WHVF31	GVF36	GVF42	GVFS20	GVFS60	GVFL18	GVFL24	GVFL30
Louvers (antique brass, brushed stainless steel and painted black finishes)	-	-	-	0	0***	-	-	-	-	-
Ornamental Insets (painted black, 24 Karat gold plated and satin chrome finishes)	-	-	-	0	-	-	-	-	-	-
3" Bevelled Trim (brushed stainless steel and textured painted black finishes)	-	-	-	0	-	-	-	0*	0*	0*
6" Bevelled Trim (textured painted black finishes)	-	-	-	0	-	-	-	-	-	-
Fronts & Frames (diamond dust pewter, brushed stainless steel and painted metallic black finishes)	0	-	-	-	-	-	-	-	-	-
Mounting Cabinets (brushed stainless steel and painted metallic black finishes)	0	-	-	-	-	-	-	-	-	-
Stove Top Insets (lorena slate and ubatuba green)	-	-	-	-	-	0	-	-	-	-
Cast Iron Surround Kit (painted black finishes)	-	-	-	0	-	-	-	-	-	-
Rectangular Surrounds (painted black and diamond dust pewter finishes)	-	-	0	-	-	-	-	-	-	-
Convex Surround (brushed stainless steel finish)	-	-	0	-	-	-	-	-	-	-
MIRRO-FLAME® Porcelain Reflective Radiant Panels	S	S	-	0	0	S	-	-	-	-
Decorative Sandstone Brick Panels	-	-	-	0	0	-	0	-	-	-
Traditional Andirons (painted black finish)	-	-	-	0	0	-	0	S*	S*	S*
LED Accent Lights	0	-	0	-	-	-	-	-	-	-
Cobblestone Brick Kit	-	-	-	-	-	-	-	0*	0*	0*
Safety Screen	-	-	0	0	-	-	-	-	-	-
Fireplace Screen	-	-	-	S	S	-	-	S*	S*	S*
Heat Circulating Blower Kit	-	-	-	0	0	0	0	0*	0*	0*
Millivolt Wall Thermostat	-	-	-	0	0	0	0	0	0	0
Electronic Ignition	-	S	S	-	-	-	-	-	-	-
Oxygen Depletion Sensor (ODS)	S	S	S	S	S	S	S	S	S	S
Pre-wired For Wall Switch	-	-	-	S	S	-	-	-	-	-
On/off Remote with Digital Screen	-	-	0	0	0	0	0	0	0	0

*Painted black finish only

**Brushed stainless steel finish only

***Painted black & brushed stainless steel only

*If Zero Clearance firebox is also installed

Thermostats not available on non-heater appliances in the United States

Torch™ - GVFT8
Shown on pages 4 & 5

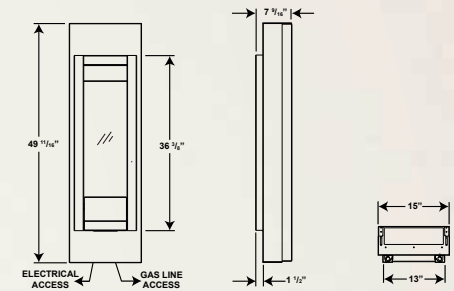

Model	BTU's (Input)		Height (With Cabinet)	Front Width (With Cabinet)	Depth (With Cabinet)	ODS	Efficiencies (Steady State)	Glass Door	Blower Kit	Mobile Home Certified	Electronic Ignition
	Natural Gas	Propane									
Torch™	6,000	6,000	49 11/16"	13"	7 9/16"	Included	99.9%	Included	N/A	Yes	Yes

Certified under American National Standards.

Plazmafire™ - WHVF24
Shown on pages 6 & 7

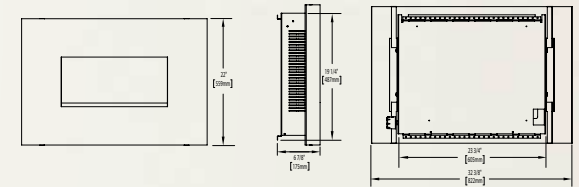

Model	BTU's (Input)		Height		Front Width		Depth		ODS	Efficiencies (Steady State)	Safety Pull Screen	Blower Kit	Mobile Home Certified	Electronic Ignition
	Natural Gas	Propane	Actual	Framing	Actual	Framing	Actual	Framing						
Plazmafire™ 24	9,000	9,000	22"	N/A*	32 3/8"	N/A*	6 7/8"	N/A*	Included	99.9%	Included	N/A	Yes	Yes

Certified under American National Standards.

Plazmafire™ - WHVF31
Shown on pages 6 & 7

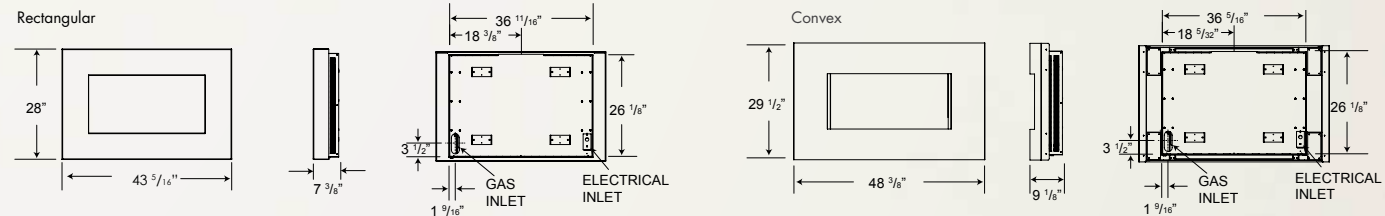

Model	BTU's (Input)		Height		Front Width		Depth		ODS	Efficiencies (Steady State)	Glass Door	Blower Kit	Mobile Home Certified	Electronic Ignition
	Natural Gas	Propane	Actual	Framing	Actual	Framing	Actual	Framing						
Plazmafire™ 31 - Rectangular	20,000	20,000	28"	N/A*	43 5/16"	N/A*	7 3/8"	N/A*	Included	99.9%	Included	N/A	Yes	Yes
Plazmafire™ 31 - Convex	20,000	20,000	29 1/2"	N/A*	48 3/8"	N/A*	9 1/8"	N/A*	Included	99.9%	Included	N/A	Yes	Yes

Certified under American National Standards.

*Consult your owners' manual for wall bracket installations. Figures may vary with individual conditions such as floor plan layout, insulation value/heat loss of the house and geographical location. Measurements to be used as a guide only. Consult your owner's manual for complete and up-to-date installation instructions and proper clearances to combustible materials. Vent Free units are not approved in Canada and some States. Plazmafire™ 24 & 31 manufactured in China at Napoleon® Guangzhou.

GVF36 - 36" Fireplace
Shown on pages 8 & 9

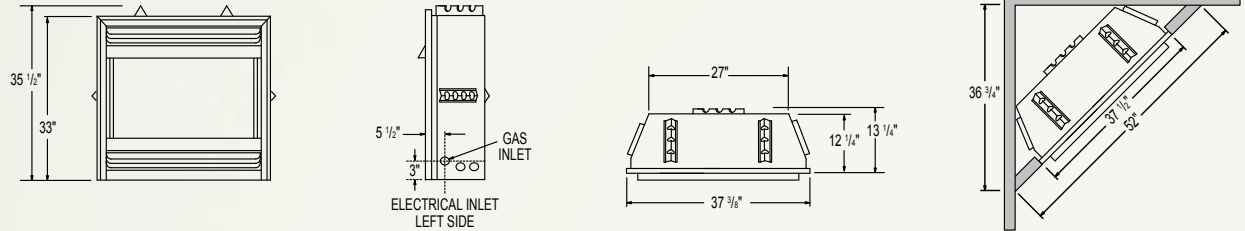

Model	BTU's (Input)		Height		Front Width		Depth		ODS	Efficiencies (Steady State)	Safety Pull Screen	Blower Kit	Mobile Home Certified	Electronic Ignition
	Natural Gas	Propane	Actual	Framing	Actual	Framing	Actual	Framing						
GVF36	30,000	30,000	35 1/2"	35 3/4"	37 3/8"	37 3/4"	13 1/4"	13 1/2"	Included	99.9%	Included	Optional	Yes	No

Certified under American National Standards.

GVF42 - 42" Fireplace
Shown on pages 10 & 11

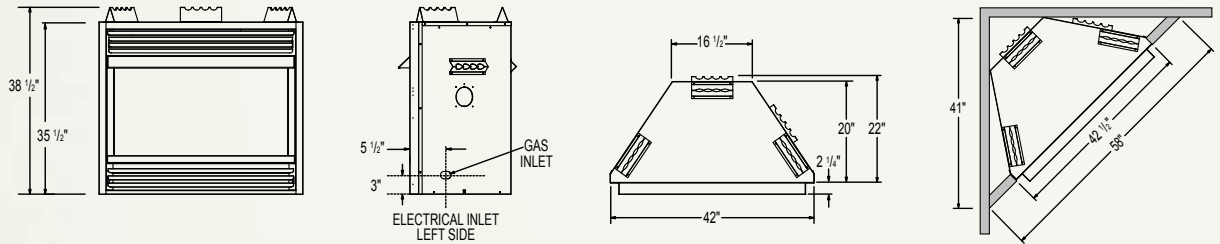

Model	BTU's (Input)		Height		Front Width		Depth		ODS	Efficiencies (Steady State)	Safety Pull Screen	Blower Kit	Mobile Home Certified	Electronic Ignition
	Natural Gas	Propane	Actual	Framing	Actual	Framing	Actual	Framing						
GVF42	30,000	30,000	38 1/2"	39"	42"	42 1/2"	22"	22 1/2"	Included	99.9%	Included	Optional	Yes	No

Certified under American National Standards.

Arlington™ - GVFS20
Shown on pages 12 & 13

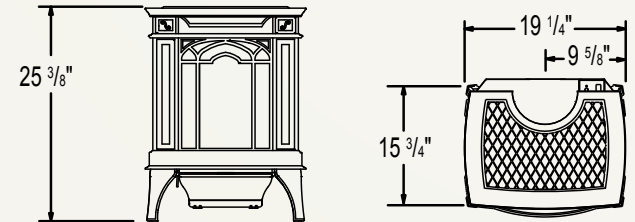

Model	BTU's (Input)		Height	Front Width	Depth	ODS	Efficiencies (Steady State)	Safety Pull Screen	Blower Kit	Mobile Home Certified	Electronic Ignition
	Natural Gas	Propane									
Arlington™	23,000	23,000	25 3/8"	19 1/4"	15 3/4"	Included	99.9%	Included	Optional	Yes	No

Certified under American National Standards.

Figures may vary with individual conditions such as floor plan layout, insulation value/heat loss of the house and geographical location. Measurements to be used as a guide only. Consult your owner's manual for complete and up-to-date installation instructions and proper clearances to combustible materials. Vent Free units are not approved in Canada and some States.

GVFS60 - Gas Stove

Shown on pages 14 & 15

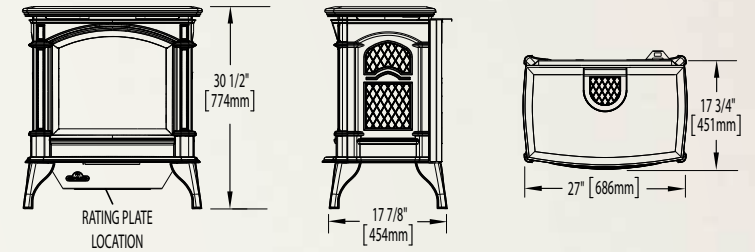

Model	BTU's (Input)		Height	Front Width	Depth	ODS	Efficiencies (Steady State)	Safety Screen	Blower Kit	Mobile Home Certified	Electronic Ignition
	Natural Gas	Propane									
GVFS60	30,000	30,000	30 1/2"	27"	17 7/8"	Included	99.9%	Included	Optional	Yes	No

Certified under American National Standards.

FIBERGLOW[™] Log Sets

Shown on pages 16 & 17

Model	Minimum Size Fireplace Opening		
	Height	Width	Depth
FIBERGLOW [™] 18"	18"	24"	14"
FIBERGLOW [™] 24"	18"	28"	14"
FIBERGLOW [™] 30"	18"	34"	14"

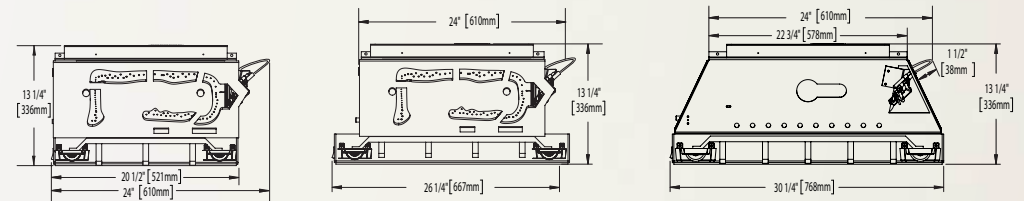
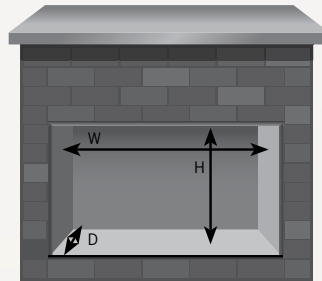

Certified under American National Standards.

Zero Clearance Kits for Vent Free Log Sets

Shown on pages 16 & 17

Model	Minimum Size Fireplace Opening		
	Height	Width	Depth
ZCVF36	32 3/4"	42 1/2"	21 1/4"
ZCVF42	35 3/4"	47 1/8"	21 1/4"

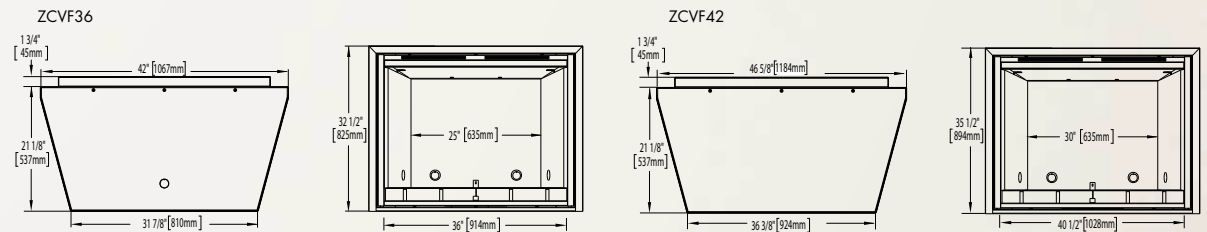

Certified under American National Standards.

Figures may vary with individual conditions such as floor plan layout, insulation value/heat loss of the house and geographical location. Measurements to be used as a guide only. Consult your owner's manual for complete and up-to-date installation instructions and proper clearances to combustible materials. Vent Free units are not approved in Canada and some States.

NAPOLEON CELEBRATING OVER 40 YEARS OF HOME COMFORT PRODUCTS



24 Napoleon Road, Barrie, Ontario, Canada L4M 0G8
103 Miller Drive, Crittenden, Kentucky, USA 41030
7200 Trans Canada Highway, Montreal, Quebec, Canada H4T 1A3

Tel: 1-866-820-8686
napoleonfireplaces.com



Authorized Dealer

Consult your owner's manual for complete installation instructions and proper clearances to combustible materials. Check all local and national building codes and gas regulations. All specifications are subject to change without prior notice due to on-going product improvements. Flame height and activity is influenced by varying vent configurations and may not appear as shown. Products may not be exactly as shown. Napoleon® is a registered trademark of Wolf Steel Ltd. © Wolf Steel Ltd. Vent free units are not approved in Canada and some States.

Printed in Canada
ADBR650 10/2015

NAPOLEON

WOOD BURNING FIREPLACES



WOOD BURNING FIREPLACES
napoleon.com



Add an element of “home” to your house with a Napoleon Wood Burning Fireplace.

High Country™ 3000 ECO.....	4 - 5
High Country™ 5000.....	6 - 7
High Country™ 6000.....	8 - 9
High Country™ 8000.....	10 - 11
Outstanding Features.....	12
Options, Features & Accessories.....	12
Anatomy of the Perfect Fireplace.....	13
Specs, Options, Features & Accessories.....	14 - 15



The High Country™ 5000 shown with Smooth Decorative Brick Panels.



FIND YOUR HAPPY (fire)PLACE.

Throughout the ages, people have gathered around fires to share in life's greatest joys.

There's just something about the glow of flickering flames that makes special moments feel even warmer.

A Napoleon fireplace is uniquely designed to brighten the vibe of any room in your house. Napoleon has an incredible range of designer options to fit any vision.

A fire not only raises the warmth and ambiance of a room, it can raise the value of your home. A fireplace offers some of the highest returns of any remodeling project. And that should make you feel good all over.

Every Napoleon fireplace is backed by the President's Limited Lifetime Warranty to ensure you can keep enjoying that positive glow for years and years and years to come.

High Country™ 3000 Eco

Wood Burning Elegance



Napoleon's High Country™ 3000 Eco wood burning fireplace is the smaller version of the powerful High Country™ 6000. The High Country™ 3000 Eco has a catalytic combustor, yes, just like your car. This fireplace has been 2020 EPA certified and achieves lowest emissions possible while still maintaining heat. Four stainless steel secondary air tubes supercharge the fuel burning process and generates a fascinating display of **YELLOW DANCING FLAMES**™.

NZ3000H-1

Glass Door Viewing Area: 17" h x 27 3/8" w

Feature Points

- Catalytic Converter
Digital Catalyst Temperature Monitor
- President's Limited Lifetime Warranty
- Advanced Airwash system
- Cast iron bypass door and baffle

For more detailed specifications on this unit, see page 14

Features & Accessories



Napoleon Handle



Steel Andirons in
Charcoal Finish



Optional Heat Resistant Gloves



Complete Arched Wrought Iron Double Doors, Faceplate, Grill & Keystone



Arched Faceplate & Modern Inset in Painted Black Finish with Painted Black Cast Iron Double Doors



Arched Faceplate & Heritage Inset in Painted Black Finish with Painted Black Cast Iron Double Doors





The High Country™ 3000 Eco shown with arched faceplate with modern insets and black cast iron double doors.

High Country™ 5000

Wood Burning Elegance



Napoleon's High Country™ 5000 Wood Burning Fireplace is perfect for adding the impact of a European-inspired, clean face design, with the traditional look and feel of an old-world fireplace. Built-in horizontal and vertical air flow directional ridges supercharge the air below and behind the wood creating extremely fast start-ups and direct the smoke up and to the back of the firebox for the ultimate clean burning experience. The counterbalanced, ZERO GRAVITY™ screen and door operate with ease, making lighting, and loading of this fireplace effortless. Bask in the glow of a wood fire that will add impact and luxury to your favorite space.

NZ5000-T

Glass Door Viewing Area: 20 7/16"h x 30 1/2"w

For more detailed specifications on this unit, see page 14

Features & Accessories



Steel Andirons in Charcoal Finish



Heat Resistant Gloves (included)



Smooth and Traditional Decorative Brick Panels



Door Handle (included)



Shown with Glass Door Down and Smooth Decorative Brick Panels



Shown with Screen Door Down and Smooth Decorative Brick Panels



Shown with Glass Door Down and Traditional Decorative Brick Panels





The High Country™ 5000 shown with Smooth Decorative Brick Panels.

High Country™ 6000

A Showcase For Your Home



The perfect blend of elegant, rustic styling and state-of-the-art wood burning technology makes this luxurious fireplace an ideal choice to add class and artistry to your home. The High Country™ 6000 stands out in the crowd and is well deserving of the Napoleon insignia. Treasured for its quality and performance, every Napoleon fireplace is hand crafted to last for generations.

NZ6000-1

Glass Door Viewing Area: 20 3/8" h x 34 3/4" w

For more detailed specifications on this unit, see page 15



Complete Arched Wrought Iron Double Doors, Faceplate, Grill & Keystone



Shown Complete with Arched Black Cast Iron Double Doors, Arched Faceplate, Grill & Keystone in Painted Black Finish

Features & Accessories



Andirons Painted Black Finish



Optional Arched Screen Kit Painted Black Finish



Optional Country Crane & Hearth Pot



Optional Heat Resistant Gloves





The High Country™ 6000 shown with wrought iron finish double doors, faceplate, upper grill and keystone

High Country™ 8000

Warming Homes & Hearts



The Napoleon High Country™ 8000 is a large, clean face wood burning fireplace with an exceptionally wide viewing area. The exclusive counterbalanced ZERO GRAVITY™ door system operates the screen and heat radiating ceramic glass independently. This allows the fire to be viewed through either the glass, screen or both as they glide effortlessly up behind the wall. Boasting a large firebox that is lined with custom molded refractory brick, the High Country™ 8000 can hold up to 50 lbs of wood.

NZ8000

Glass Door Viewing Area: 26 9/16"h x 39 13/16"w

For more detailed specifications on this unit, see page 15



Shown with Smooth Decorative Brick Panels



Shown with Traditional Decorative Brick Panels



Shown with Herringbone Decorative Brick Panels

Features & Accessories



Steel Andirons in Charcoal Finish



Heat Resistant Gloves



Smooth Decorative Brick Panels



Traditional Decorative Brick Panels



Herringbone Decorative Brick Panels





The High Country[®] 8000 shown with Traditional Decorative Brick Panels.

Outstanding Features

of Napoleon's Advanced Technology

Help Protect The Environment With A Napoleon Wood Burning Fireplace

Heating your home with a Napoleon high efficiency fireplace, stove or insert releases no more carbon dioxide than a dying tree would lying on the forest floor. In fact, when the entire carbon cycle is considered, a Napoleon fireplace heats your home more efficiently and with less impact on the environment than any other heating fuel option.

Outstanding Craftsmanship

Fine details are designed in every aspect of Napoleon fireplaces... individually handcrafted with pride of excellence.

WHISPER QUIET™ Heat Circulating Blower System

The extreme heat resistant "H" class bearings featured in Napoleon's superior heat circulating blower, creates a lasting "whole home" comfort with adjustable high & low speeds. Available on the NZ3000H-1 and NZ6000-1 only.

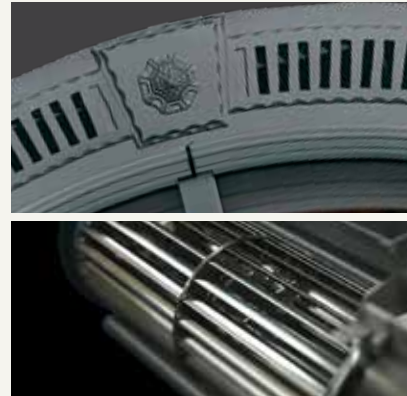
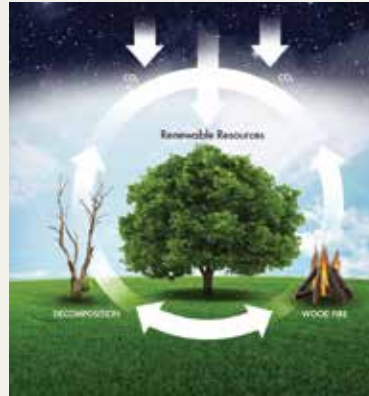

ZERO GRAVITY™ Door System

The ZERO GRAVITY™ door system found on the 5000 and 8000 models, boast glass and screen doors that have precision 4-way roller systems that have been proven and tested to 60 years of operation. The door system also allows glass and screen doors to operate independently and glide up behind the wall.

Features, Options & Accessories

Decorative Brick Options

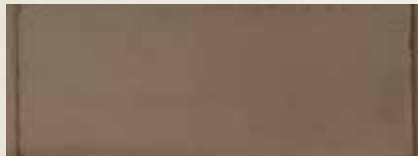

Smooth Decorative Brick Panels
(NZ5000 and NZ8000 Models Only)



Traditional Decorative Brick Panels
(NZ5000 and NZ8000 Models Only)



Herringbone Decorative Brick Panels
(NZ8000 Model Only)

Accessories



Steel Andirons Charcoal Finish
(Excluding NZ6000 Model)



Andirons Painted Black Finish
(NZ6000 Model Only)



Heat Resistant Gloves



Decorative Handle



Country Crane & Hearth Pot
(NZ6000 Model Only)



Arched Screen Kit Painted Black Finish
(NZ6000 Model Only)

High Country™ 3000 Eco



Anatomy of the Perfect Fireplace

1. Primary combustion air is brought into the unit through the fresh air intake collar located on the bottom side of the unit.
2. Catalytic combustor increases efficiency, decreases emissions and provides longer burn times.
3. Combustion takes place inside the firebox where smoke and gases are directed around a large baffle and through a catalyst (similar to the technology in a car) which burns off harmful gasses. As these gasses burn, the catalyst radiates more heat into the room providing maximum efficiency.
4. The optional hot air gravity central heating vent system may be used to distribute heat to an adjoining room (located either above or beside the room containing the fireplace).
5. The optional blower provides an ideal means of circulating warm air within the home. Where location permits and extreme cold temperatures are not experienced, this blower may also be installed to utilize fresh outside air to introduce "positive pressure" to the home. The powerful 320 CFM blower can be installed remotely from the unit (ie. basement) so you can enjoy increased air circulation with WHISPER QUIET operation.
6. Radiant Heat.
7. A single air control regulates the burn rate.
8. High Heat Ceramic Glass for added durability.
9. Primary air is directed down along the glass before being combusted to help keep the glass clean.
10. Fully insulated outershell to reduce clearances.
11. Pre-heated secondary combustion air is injected into the top of the fire box to help combust any un-burnt fuel gasses before they reach the catalyst. This provides both a dazzling blanket of fire and extracts the maximum amount of heat per fuel load.
12. Cast iron baffle and bypass door are durable and allow for easy start up and refueling.
13. Cool Room air circulates around the firebox and is pushed back into the room for additional heat.

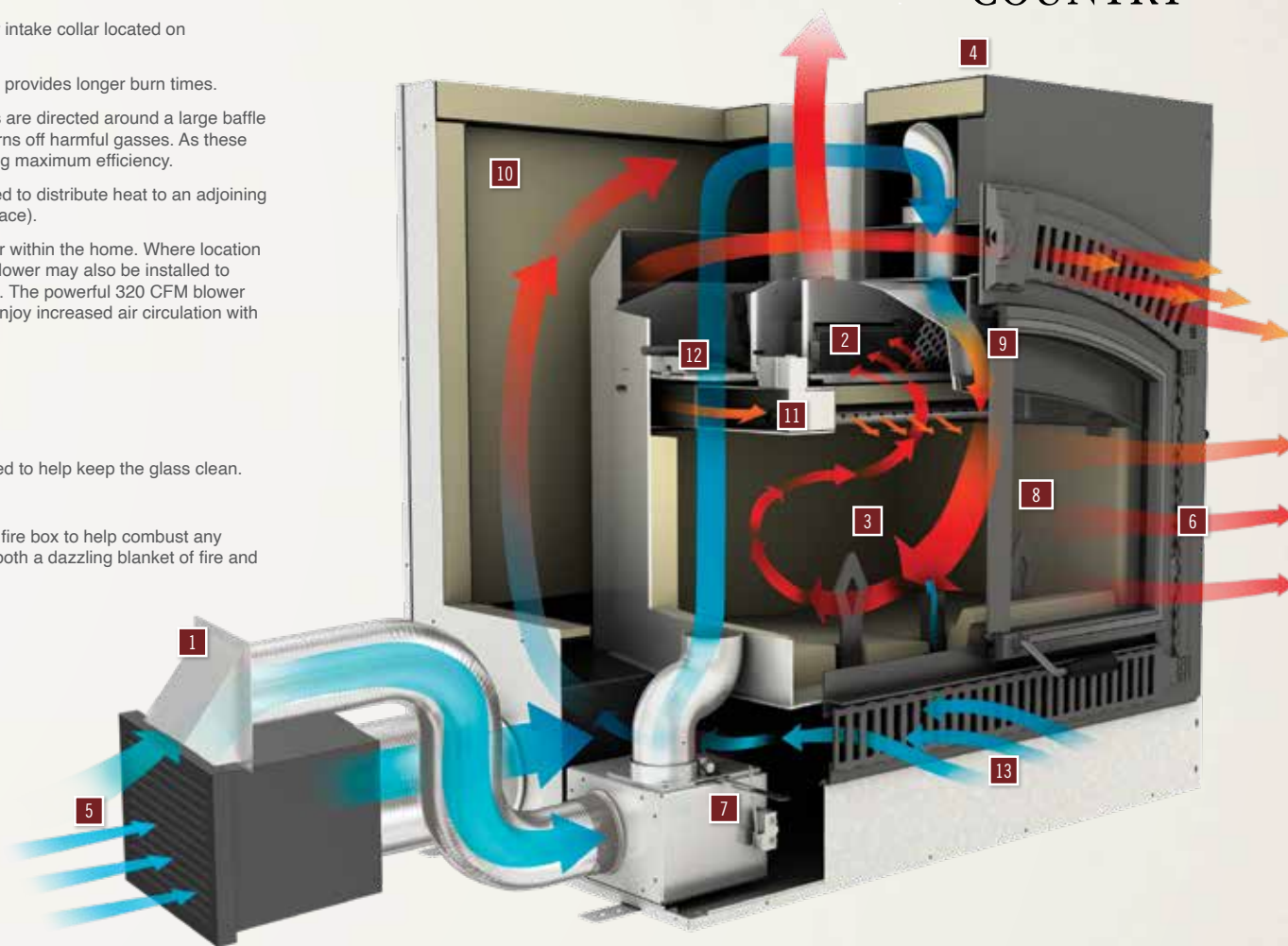

Approved with chimneys

Any 7" diameter chimney listed to these standards may be installed. In accordance with these standards, the unit may also be connected to any chimney listed to CAN/ULC-S604 and CAN/ULC-S629 for Canada or UL-103HT for the United States.

Minimum Clearance to combustibles

Minimum, fireplace	0" to stand offs (rear) 6" to sides
Ceiling enclosure	84" from the base of the unit
Ceiling (in front of fireplace)	84" from the base of the unit
Chimney	2" (follow manufacturer's instructions)
Hot air gravity duct work	1"
Mantle to top of faceplate	from 12" (with mantel protruding 2") to 18" (with mantel protruding 8")
Minimum hearth extension	20" x 54" non-combustible surface

Hot Air Venting Options

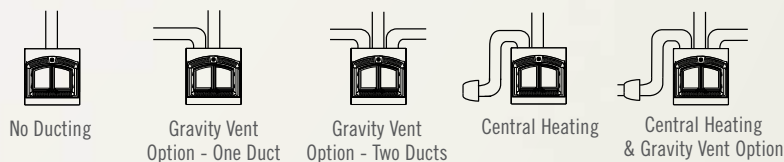

High Country™ 3000 Eco

Shown on pages 4 & 5

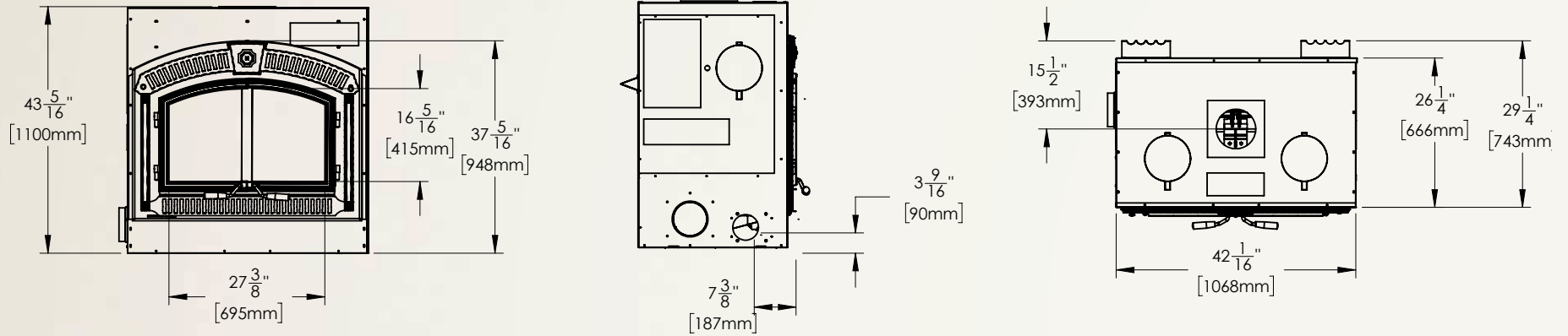

High Country™ 5000

Shown on pages 6 & 7

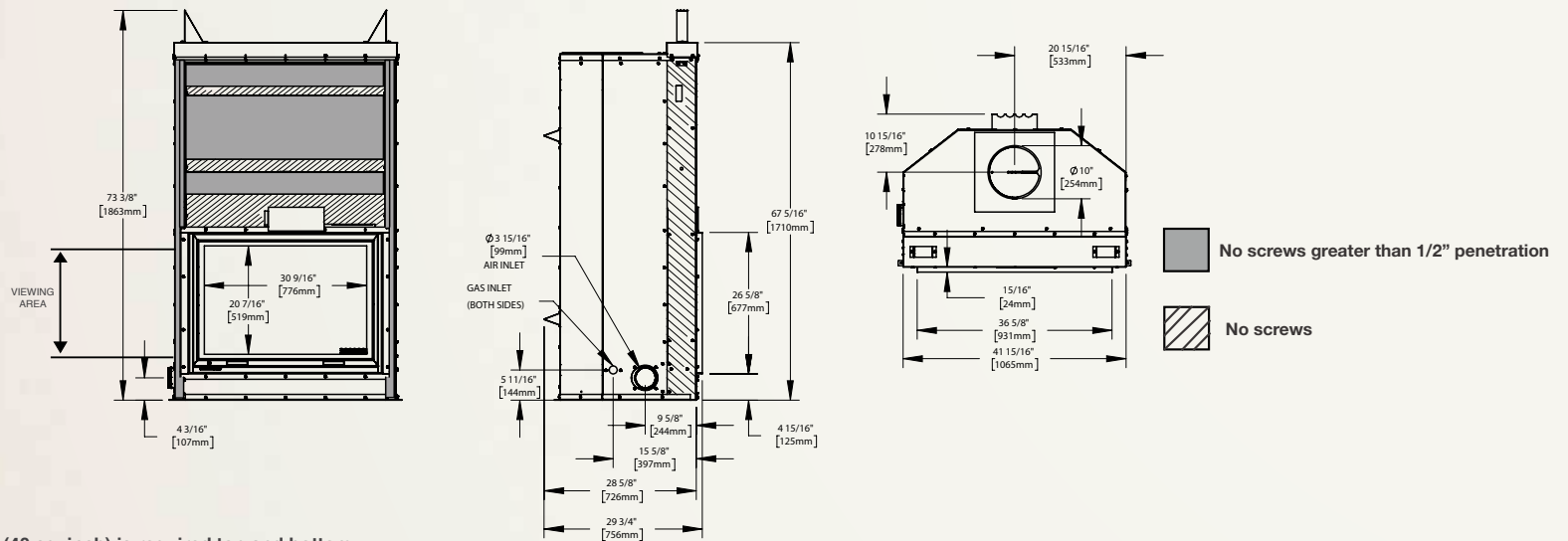

NOTE: A ventilated enclosure (40 sq. inch) is required top and bottom.

Model	Firebox Size (cu. ft.)	Area Heated (sq. ft.)	Emissions (Grams Per Hour)	Log Size (Max)	Chimney Diameter	Outside Air for Combustion	EPA Certified	Mobile Home Approved	Central Heating and/or Blower	Door Opening		Viewing Area		Viewing Area (sq.inch)	Weight of Bricks	Weight without Bricks
										Width	Height	Width	Height			
NZ3000H-1*	2.3	2000 +	1.38	25"	7"	Yes	Yes	No	Optional	40"	31 11/16"	27 3/8"	17"	391	103 lbs	448 lbs
NZ5000**	6.6	1000	4.6	24"	8"	Yes	Yes	No	N/A	36 5/8"	26 5/8"	30 1/2"	20 7/16"	623	193 lbs	552 lbs

*Tested and listed by Services Polytests inc. as per EPA METHODS ALT-125, ASTM, E2515, ASTM E3053 and CSA B415.1 for CATALYTIC WOOD HEATER FOR EMISSIONS AND EFFICIENCY to US EPA's cord wood emissions standards for 2020 (EPA 40 CFR Part 60 Subpart AAA). CERTIFIED TO COMPLY WITH 2020 PARTICULATE EMISSIONS STANDARDS.

Figures may vary with individual conditions such as floor plan layout, insulation value of the home and the firewood used. Rated BTU/h with softwood test fuel (for emissions only) - no refueling. Wolf Steel Ltd. own test results showing realistic BTU's using hardwood logs with regular refueling. Heat output will differ on chimney draft as well as type, moisture content and size of wood.

High Country™ 6000

Shown on pages 8 & 9

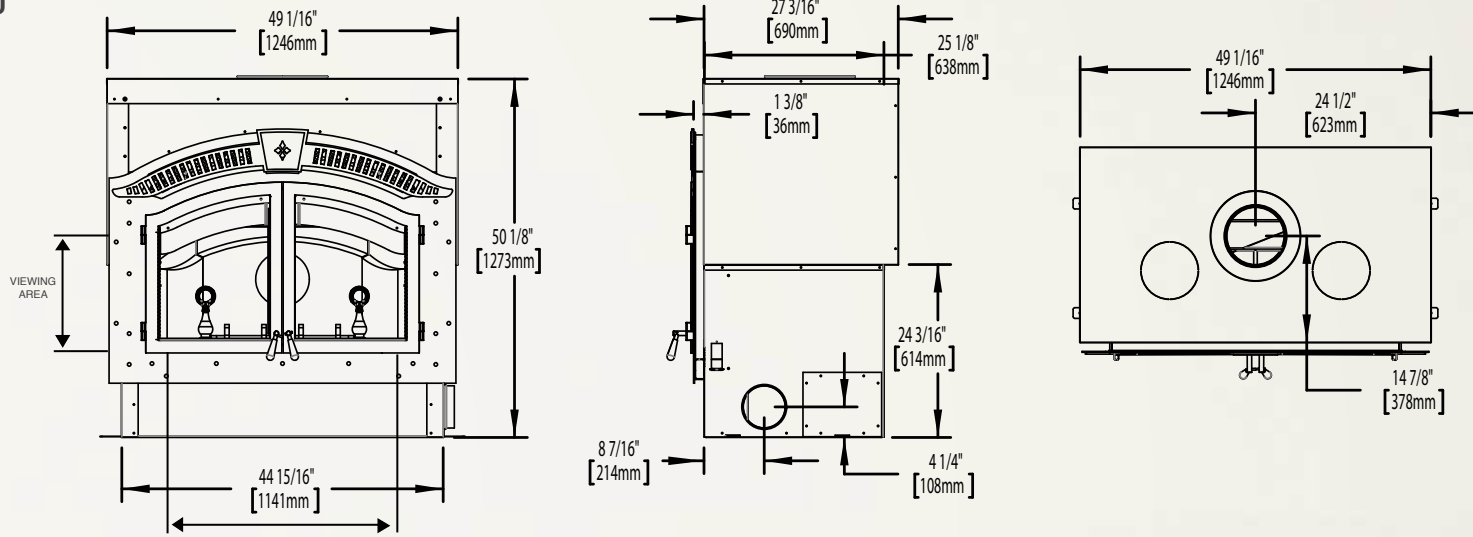
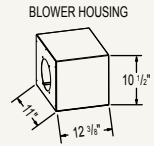

High Country™ 8000

Shown on pages 12 & 13

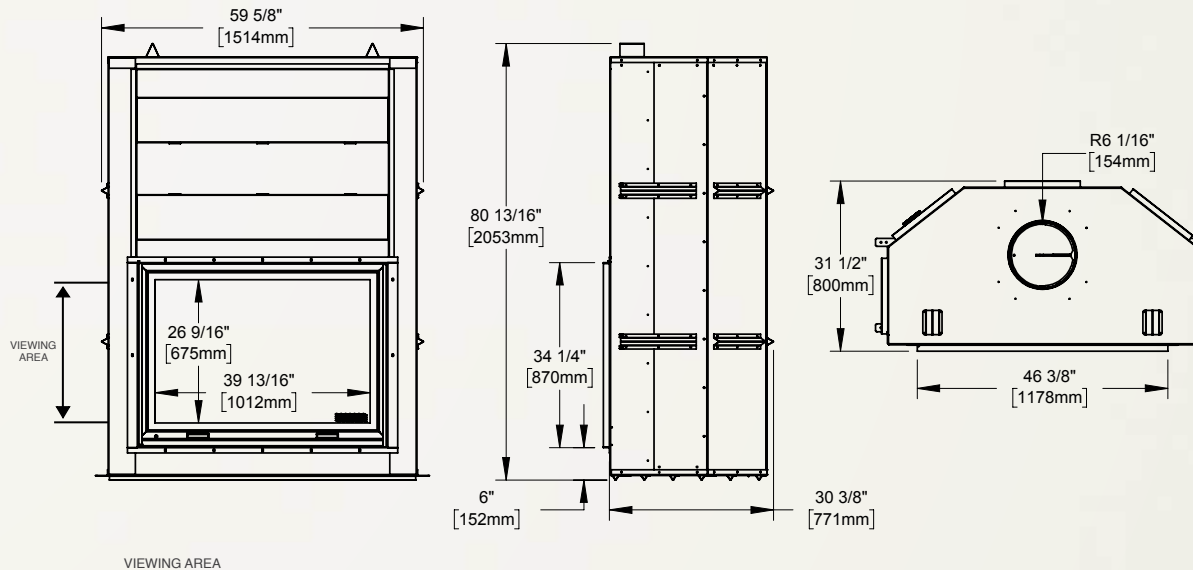

Model	Firebox Size (cu. ft.)	Area Heated (sq. ft.)	Emissions (Grams Per Hour)	Log Size (Max)	Chimney Diameter	Outside Air for Combustion	EPA Qualified	Mobile Home Approved	Central Heating and/or Blower	Door Opening		Viewing Area		Viewing Area (sq. inch)	Weight of Bricks	Weight without Bricks
										Width	Height	Width	Height			
NZ6000-1**	4.8	3000 +	N/A	32"	8"	Yes	N/A	No	Optional	48 1/2"	26 5/8"	34 3/4"	16 5/8"	708	110 lbs	583 lbs
NZ8000**	9.65	1000	2.2	32"	10"	Yes	Yes	No	No	46 3/8"	34 1/4"	22"	28 1/2"	1057	300 lbs	1150 lbs

*Tested and listed by Services Polytests inc. as per EPA METHODS ALT-125, ASTM, E2515, ASTM E3053 and CSA B415.1 for CATALYTIC WOOD HEATER FOR EMISSIONS AND EFFICIENCY to US EPA's cord wood emissions standards for 2020 (EPA 40 CFR Part 60 Subpart AAA). CERTIFIED TO COMPLY WITH 2020 PARTICULATE EMISSIONS STANDARDS.

Figures may vary with individual conditions such as floor plan layout, insulation value of the home and the firewood used. Rated BTU/h with softwood test fuel (for emissions only) - no refueling. Wolf Steel Ltd. own test results showing realistic BTU's using hardwood logs with regular refueling. Heat output will differ on chimney draft as well as type, moisture content and size of wood.

NAPOLEON

CELEBRATING OVER 40 YEARS OF HOME COMFORT PRODUCTS



24 Napoleon Road, Barrie, Ontario, Canada L4M 0G8
 103 Miller Drive, Crittenden, Kentucky, USA 41030
 7200 Trans Canada Highway, Montreal, Quebec, Canada H4T 1A3

Tel: 1-866-820-8686
 napoleon.com



Authorized Dealer

Consult your owner's manual for complete installation instructions and proper clearances to combustible materials. Check all local and national building codes and regulations. All specifications are subject to change without prior notice due to on-going product improvements. Products may not be exactly as shown. Heat output will vary based on fuel type, quality and moisture content. Napoleon is a registered trademark of Wolf Steel Ltd. © Wolf Steel Ltd.

NAPOLEON

WOOD BURNING STOVES AND INSERTS

WOOD BURNING STOVES AND INSERTS
napoleon.com



Innovative features for incomparable heating quality.

Wood Burning Stoves

S20 4 - 5

S25 6 - 7

Wood Burning Inserts

S20i & S25i 8 - 9

Oakdale™ EPI3C & EPI13T 10 - 11

Outstanding Features of Napoleon's Advanced Technology 12

Napoleon's EPA Technology 13

Detailed Specifications 14 - 15

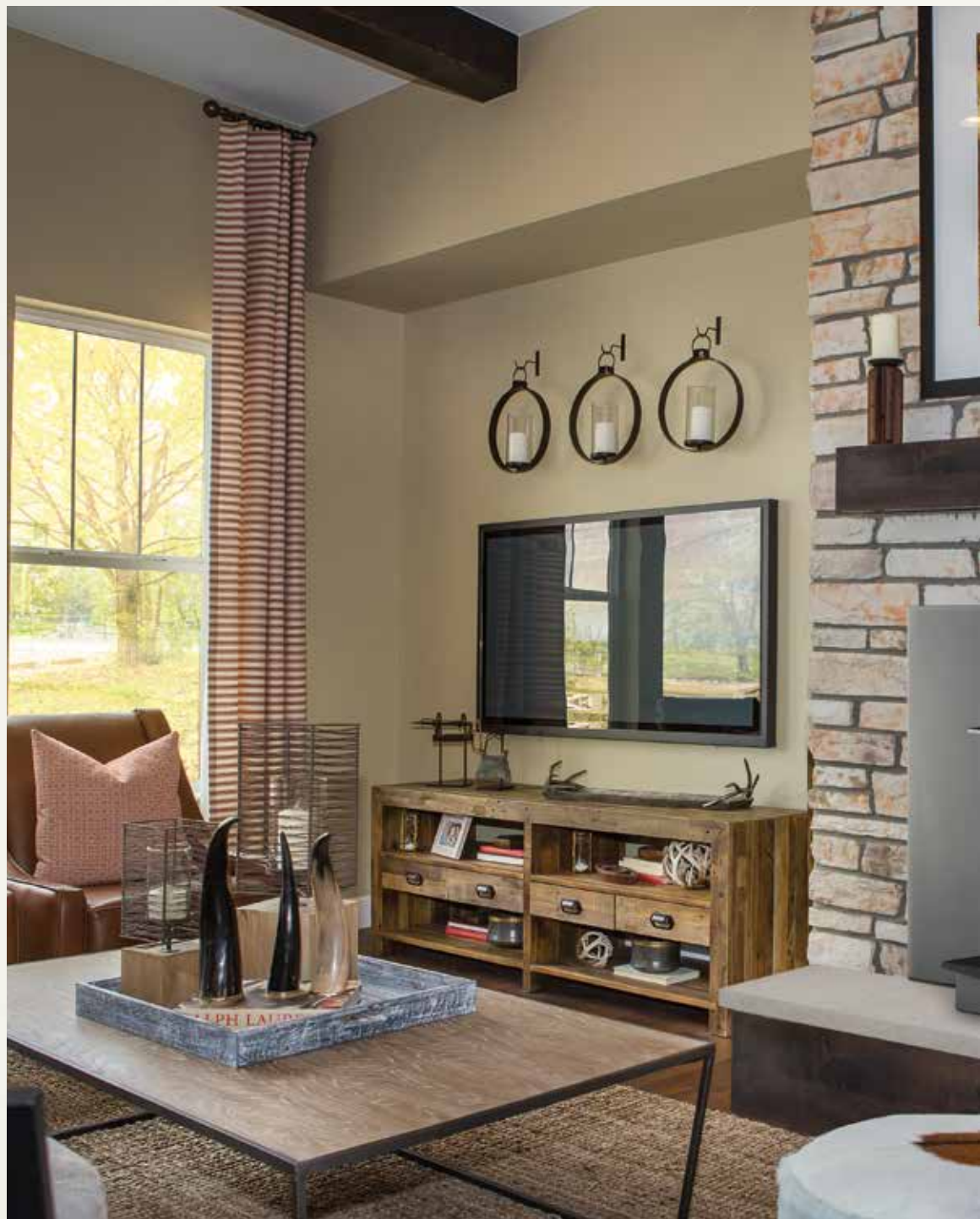

S20i shown with backer plate.



FIND YOUR HAPPY (fire)PLACE.

Throughout the ages, people have gathered around fires to share in life's greatest joys.

There's just something about the glow of flickering flames that makes special moments feel even warmer.

A Napoleon fireplace is uniquely designed to brighten the vibe of any room in your house. Napoleon has an incredible range of designer options to fit any vision.

A fire not only raises the warmth and ambiance of a room, it can raise the value of your home. A fireplace offers some of the highest returns of any remodeling project. And that should make you feel good all over.

And so you can keep enjoying that positive glow for years and years and years to come, every Napoleon fireplace is backed by the President's Limited Lifetime Warranty.

S-Series - S20

Heating up to 1,800 sq. ft.

The S20 wood burning stove is the smallest of the efficient burning stove lineup, offers the best of Napoleon's wood burning technology and is EPA certified. A heavy-duty firebox top and full-width ash lip to protect your floor from debris, while a large ash pan with easy glide rollers ensures cleanup is effortless. Clean and contemporary lines allow this wood burning stove to blend into your current décor while remaining highly efficient.

S20

Up to 65,000 BTU's

26" w x 34 1/4" h x 28 3/8" d

EPA Certified

For more detailed specifications on these units, see page 14

Features



Hidden Door Hinges



Large Viewing Area



Reduced Clearance Heat Shield (Optional)



"Easy Glide" Ash Drawer & Removable Ash Pan



Blower Kit (Optional)



S20 - Contemporary small-sized wood stove complete with cast door, cast ash lip and cast pedestal base



S Series S20 Wood Stove



S-Series - S25

Heating up to 2,100 sq. ft.

The S25 wood burning stove is clean and contemporary looking and features EPA 2020 certified wood burning technology. Extremely long burn times ensure you can watch the fire for pleasure instead of babysitting the fire for reloading. A heavy-duty firebox top and full-width ash lip to protect your floor from debris, while a large ash pan with easy glide rollers ensures cleanup is effortless. Clean and contemporary lines allow this wood burning stove to blend into your current décor while remaining highly efficient.

S25

Up to 70,000 BTU's

28 3/4" w x 37 1/2" h x 30 7/8" d

EPA Certified

For more detailed specifications on these units, see page 14

Features



Hidden Door Hinges



Large Viewing Area



Reduced Clearance Heat Shield
(Comes installed on Stove)



"Easy Glide" Ash Drawer &
Removable Ash Pan



Blower Kit (Optional)



S25 - Contemporary medium-sized wood stove
complete with cast door, cast ash lip
and cast pedestal base



S Series S25 Wood Stove



VORTEX
SERIES

S-Series Wood Burning Inserts

S20i & S25i

The S-Series wood burning fireplace inserts are clean and contemporary looking. Featuring EPA 2020 certified wood burning technology and extremely long burn times. The extra-large viewing area ensures that you can watch the fire for pleasure instead of babysitting the fire for reloading. An included dual blower system quietly circulates heat throughout your room. Clean and contemporary lines allow this wood burning fireplace insert to blend into your current décor while remaining highly efficient.

S20i

Up to 65,000 BTU's

Unit size 25 3/8" w x 21 3/4" h x 22 7/16" d

With backerplate 41" w x 30" h

Heating up to 1800 sq. ft.

EPA Certified

S25i

Up to 70,000 BTU's

Unit size 28 3/4" w x 23 1/6" h x 26 1/8" d

With standard backerplate 41" w x 30" h

With large backerplate 48" w x 33" h

Heating up to 2100 sq. ft.

EPA Certified

For more detailed specifications on these units, see page 14

Options & Accessories



Large Viewing Area



Hidden Door Hinges



Blower Kit (Included)





The S25i shown with Large Backer Plate



Oakdale™ Traditional & Contemporary

Heating up to 1,500 sq. ft.

A wood burning insert that will match any décor whether it be traditional or contemporary. The Oakdale™ Traditional has a flush front with a cast iron surround and the Oakdale™ Contemporary has a contemporary flush front with a cast iron surround. Four stainless steel secondary air tubes supercharge the fuel burning process and generate a beautiful display of **YELLOW DANCING FLAMES**™. Complete with a removable log retainer and a heat circulating blower, these inserts are perfect heating solutions for your home or cottage.

Oakdale™ Contemporary

EPI3C

Up to 55,000 BTU's

42½" w x 29½" h as shown

EPA Certified

Oakdale™ Traditional

EPI3T

Up to 55,000 BTU's

42½" w x 28½" h as shown

EPA Certified

For more detailed specifications on these units, see page 15



The Oakdale™ Contemporary shown with painted black removable log retainer

Options & Accessories



WHISPER QUIET™ Heat Circulating Blower System (included)



Removable Log Retainer
Painted Black Finish
(included)



Oakdale™ Traditional Front
Painted Black Finish



Oakdale™ Traditional Front
Porcelain Enamel Majolica Finish



Oakdale™ Contemporary Front
Painted Black Finish





The Oakdale™ Traditional shown in porcelain enamel Majolica brown finish with painted black removable log retainer



Outstanding Features

of Napoleon's Advanced Technology

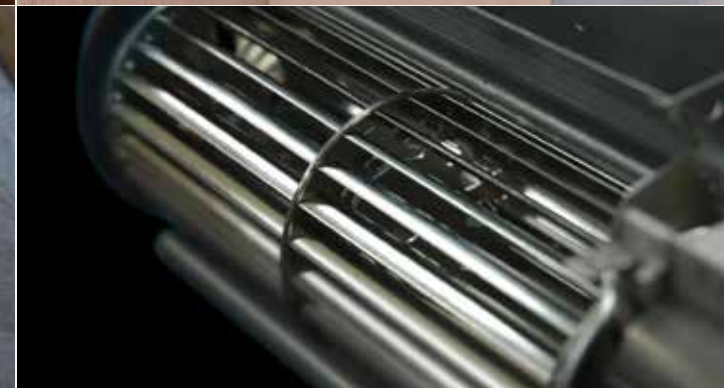
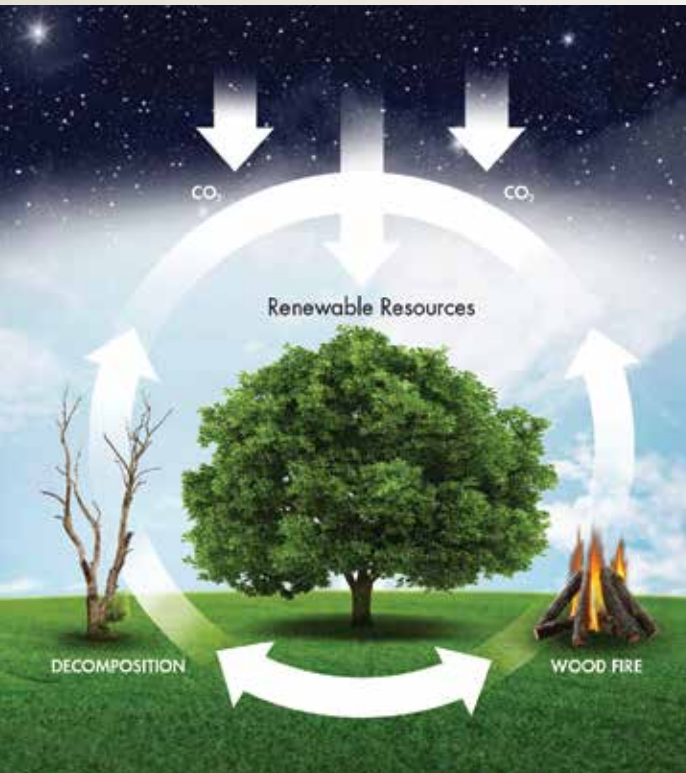

Help Protect the Environment with a Napoleon Wood Burning Stove or Insert

Heating your home with a Napoleon high efficiency, EPA (Environmental Protection Agency) approved fireplace, stove or insert releases no more carbon dioxide than a dying tree would lying on the forest floor. In fact, when the entire carbon cycle is considered, a Napoleon EPA approved stove or insert heats your home more efficiently and with less impact on the environment than any other heating fuel option.

Dual Vortex™ Action

To achieve an extraordinary clean burn without a catalytic combustor, horizontal jets of super heated secondary air are mixed with the fire's smoke to burn off released smoke particles. You can watch the spirals of secondary flames just below the top baffle during most of the burn.

Vortex™ Baffle - Lifetime Warranty*

Manufactured from high density material, Napoleon's exclusive Vortex™ baffle provides an unprecedented level of durability while ensuring complete combustion resulting in a clean burning, environmentally friendly wood burning stove.

*See dealer for details

Secondary Air Tube - Kiln Construction

Napoleon's secondary air tube is insulated with ceramic fiber and protected with a cover plate, ensuring complete combustion. This fully lined refractory firebox acts as a kiln, concentrating the maximum amount of heat to efficiently heat your home.

WHISPER QUIET™ Blower System

The extreme heat resistant "H" class bearings featured in Napoleon's superior heat circulating blower, creates a lasting "whole home" comfort with adjustable high and low speeds.

Napoleon's EPA Technology

Wood Burning Stoves

1. Economical 6" flue on even the largest models, assures you of efficiency and cost saving installations
2. Primary "bottom air feed" assists in cold startups and to revive a small, dying fire
3. Secondary air tube insulated for complete combustion
4. Wrap around side shields add a delicate balance of elegance and functional practicality helping to disperse heat evenly and reduce clearances to combustibles
5. Large viewing area through an elegantly arched cast iron door
6. High heat ceramic glass provides a safe, unobstructed view of the fire
7. Effective air wash in combination with high temperatures keeps the viewing glass clean
8. Fully refractory lined firebox, like a kiln, maintains the interior temperatures necessary to achieve low emissions
9. Ash dump with self-closing door is readily accessible (pedestal and cast iron models)
10. Large "king size" functional ash pan (600 cubic inch capacity) with two carrying handles lets you conveniently dispose of ashes (included with pedestal and optional for leg models)
11. Folding ash pan lid allows for clean, no-mess ash removal (pedestal models)
12. Cool room air is circulated around the firebox, heated and returned to the room
13. The single lever burn control regulates primary and secondary air establishing a perfect mix and a clean burn

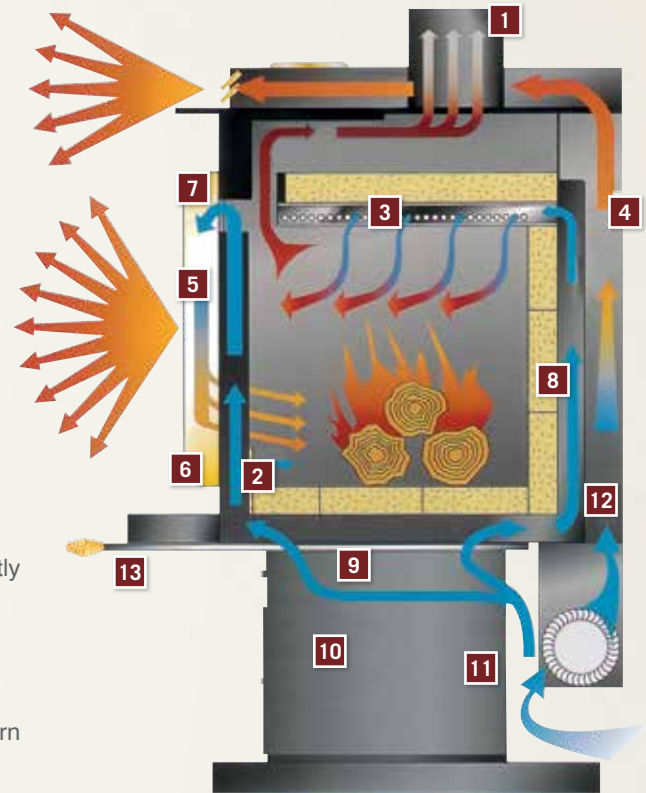

Napoleon's EPA Wood Burning Technology... more heat with less fuel. Emissions as low as 1.3 grams per hour and 72.1% overall maximum heating efficiency.

Wood Burning Inserts

1. Radiant Heat
2. High heat ceramic glass provides a safe, unobstructed view of the fire
3. Heavy duty secondary air tubes introduce just the right amount of air to increase efficiency through complete combustion (specific for the EPI3C, EPI3T and EPI3TN)
4. Cool room air is circulated around the firebox with help from circulation blower, heated and returned to the room
5. Combustion air is brought into the unit through the fresh air intake collar located on the top left outer shell
6. Combustion takes place inside the firebox, smoke and gases are moved around a baffle system into a second chamber for complete combustion and extended flame path and exhaust out the chimney
7. Primary "bottom air feed" assists in cold startups and to revive a small, dying fire
8. A single air control regulates the burn rate

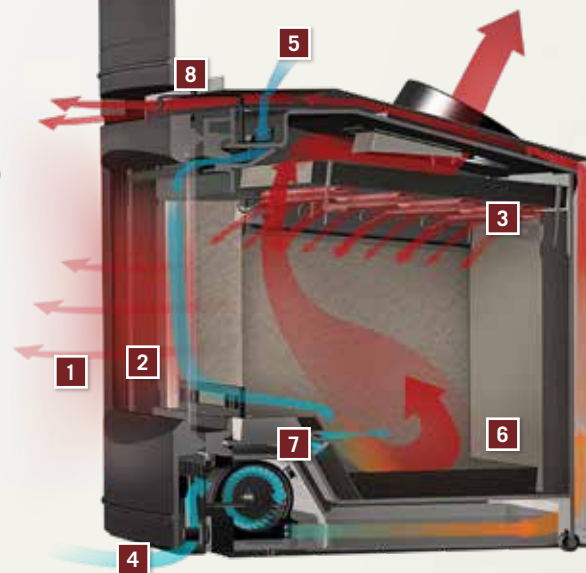

S20-1

Shown on pages 4 & 5

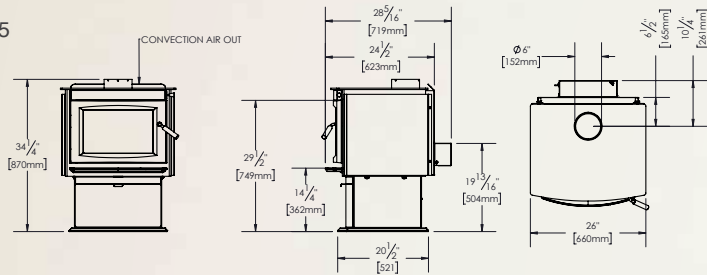

S25

Shown on pages 6 & 7

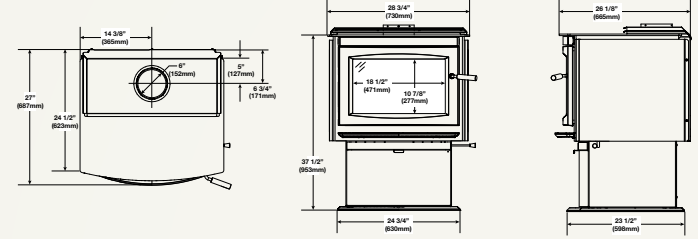

Model	BTU Heat Output*	BTU Heat Output (High Burn)**	Firebox Capacity (cu. ft.)	Area Heated (sq. ft.)***	Burn Time (Hours)	Log Size (Max)	Emissions (Grams Per Hour)	Flue Diameter		Catalytic Combustor	Mobile Home Approved	Blower Kit Available
								Top	Rear			
S20-1	12,944 - 54,127	65,000	1.9	800 - 1800	8 hrs	16"	2.25	6"	N/A	No	Yes	Optional
S25	19,195 - 54,057	70,000	2.5	Up to 2100	16 hrs	23"	1.3	6"	N/A	No	No	Optional

If the stove is to be installed on a combustible floor, it must be placed on an approved non-combustible hearth pad, that extends 8" (200mm) beyond the stove sides and back, and 18" (455mm) to the front. Clearances can be reduced with shielding acceptable to local authorities. Reduced installation must comply with NFPA211 or CAN/CSA-B365.

S20i

Shown on pages 8 & 9

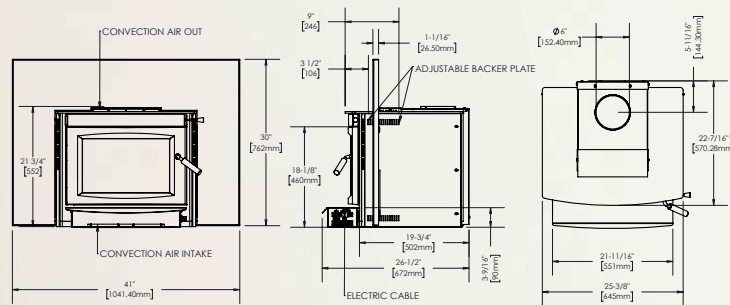

S25i

Shown on pages 8 & 9

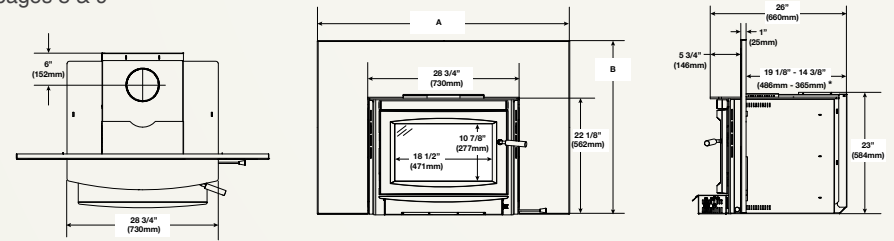

Model	BTU Heat Output*	BTU Heat Output (High Burn)**	Firebox Capacity (cu. ft.)	Area Heated (sq. ft.)***	Burn Time (Hours)	Log Size (Max)	Emissions (Grams Per Hour)	Efficiency		Mobile Home Approved	Blower Kit Available	Model	Installation	Width	Height	Depth	Weight of Bricks	Weight Without Bricks, Doors and Surround
								LHV	HHV									
S20i	12,944 - 54,127	65,000	1.9	800 - 1800	8 hrs	16"	2.25	77.54%	72.06%	No	Optional	S20i	Minimum Fireplace Opening	25 7/8"	22"	14"	48 lbs	270 lbs
S25i	19,195 - 54,057	70,000	2.5	Up to 2100	16 hrs	23"	1.3	76.99%	71.56%	No	Optional	S25i	Minimum Fireplace Opening	31"	23 1/2"	15 1/2"	60 lbs	394 lbs

This insert must be installed only into a solid fuel burning fireplace that is at least 18" (457.2mm) deep, 27" (685.8mm) wide and 22" (558.8mm) high with an approved lined chimney at least 15 feet high (4.6m) and a hearth of 18" (457.2mm) for Canada and 16" (406.4mm) for USA.

* Rated BTU/h with softwood test fuel (for emissions only) - no refueling
 ** Wolf Steel Ltd. own test results showing realistic BTU's using hardwood logs with regular refueling. Heat output will differ on chimney draft as well as type, moisture content and size of wood.
 *** Figures may vary with individual conditions such as floor plan layout, insulation value/heat loss of the house, geographical location and firewood used.

Oakdale™ Contemporary

Shown on pages 10 & 11

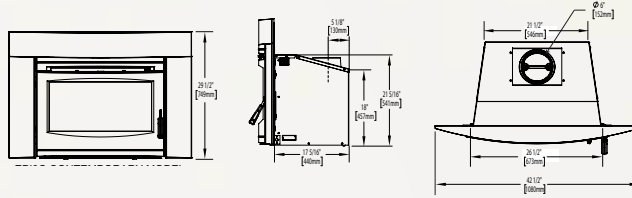

Oakdale™ Traditional

Shown on pages 10 & 11

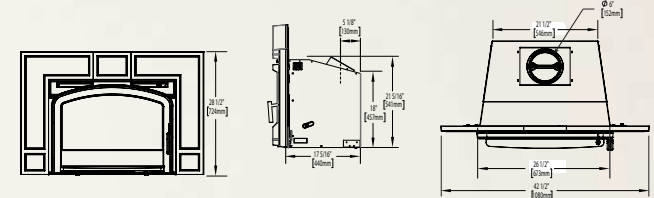

Model	BTU Heat Output*	BTU Heat Output (High Burn)**	Firebox Capacity (cu. ft.)	Area Heated (sq. ft.)***	Burn Time (Hours)	Log Size (Max)	Emissions (Grams Per Hour)	Flue Diameter		Catalytic Combustor	Mobile Home Approved	Blower Kit Available	Installation	Width	Height	Depth	Weight of Bricks	Weight Without Bricks, Doors and Surround
								Top	Rear									
EPI3C	14,492 - 47,887	55,000	1.8	1,500	8 hrs	18"	1.21	6"	N/A	No	No	Included	Minimum Fireplace Opening	28"	22"	16"	80 lbs	250 lbs
EPI3T	14,492 - 47,887	55,000	1.8	1,500	8 hrs	18"	1.21	6"	N/A	No	No	Included	Minimum Fireplace Opening	28"	22"	18"	80 lbs	250 lbs

This insert must be installed only into a solid fuel burning fireplace that is at least 18" (457.2mm) deep, 27" (685.8mm) wide and 22" (558.8mm) high with an approved lined chimney at least 15 feet high (4.6m) and a hearth of 18" (457.2mm) for Canada and 16" (406.4mm) for USA.

* Rated BTU/h with softwood test fuel (for emissions only) - no refueling.

** Wolf Steel Ltd. own test results showing realistic BTU's using hardwood logs with regular refueling. Heat output will differ on chimney draft as well as type, moisture content and size of wood.

*** Figures may vary with individual conditions such as floor plan layout, insulation value/heat loss of the house, geographical location and firewood used.

NAPOLEON

CELEBRATING OVER 40 YEARS OF HOME COMFORT PRODUCTS



24 Napoleon Road, Barrie, Ontario, Canada L4M 0G8
103 Miller Drive, Crittenden, Kentucky, USA 41030
7200 Trans Canada Highway, Montreal, Quebec, Canada H4T 1A3

Tel: 1-888-721-7253
napoleon.com



Authorized Dealer

Tested and listed by Services Polytests inc. as per EPA METHODS ALT-125, ASTM E2515, ASTM E3053 and CSA B415.1 FOR EMISSIONS AND EFFICIENCY to US EPA's cord wood emissions standards for 2020 (EPA 40 CFR Part 60 Subpart AAA). CERTIFIED TO COMPLY WITH 2020 PARTICULATE EMISSIONS STANDARDS. Consult your owner's manual for complete installation instructions and check all local and national building codes. All specifications and designs are subject to change without notice to allow for on-going product improvement. Images may not be exactly as shown. © Wolf Steel Ltd.

Printed in Canada
ADBR150 03/2021