



EXTERIOR DOORS

REEB[®] IN-STOCK EXTERIOR STILE & RAIL CATALOG



Introduction



F7860 in Douglas Fir
See Page 51 for details

Due to their traditional stile and rail construction, wood doors offer a level of definition that cannot be matched. Stile and rail wood doors are constructed using individual components which allows the doors to be made in nearly an infinite amount of designs and dimensions. Every wood door features unique grain patterns, bringing natural beauty to the entryway. Solid wood doors bring together beauty, strength, and durability for a door that can last a lifetime.

Table of Contents

Why Choose Reeb?.....	4	Sash, 7/8" SDL Bar, 3/4" Flat Panel.....	56	Brickmould & Casing.....	100
Why Buy a Wood Door?.....	5	Contemporary, Satin Etch Glass.....	58	Sills.....	102
Door Durability.....	7	French.....	60	Ultimate Astragal.....	104
Exposure Types.....	8	French, 7/8" SDL Bar.....	64	Ultimate Flip Lever Astragal.....	104
Wood Joinery.....	10	French, 1-3/8" SDL Bar.....	66	Ultimate Multi-Point Astragal.....	105
Nantucket® Collection.....	10	French, 1-1/4" TDL Bar.....	68	Ultimate Trilennium Astragal.....	105
Metropolitan™ Collection.....	12	Dutch Doors.....	70	Hinges.....	106
Performance Series®.....	14	Transoms & Dentil Shelves.....	72	Baldwin®.....	107
Standard.....	16	Sapele Mahogany.....	74	Emtek®.....	108
Wood Species.....	17	Panel, 1-7/16" DHRP.....	74	Reeb® Specialty Products.....	109
Glass Options.....	18	Sash, 7/8" SDL Bar, 1-7/16" DHRP.....	78	Hardware.....	110
Glass Types.....	19	Sash, 1-3/8" SDL Bar, 1-7/16" DHRP.....	80	Endura Trilennium®.....	110
Douglas Fir.....	20	French.....	81	Tru-Lock®.....	111
Panel, 1-7/16" DHRP.....	20	French, 7/8" SDL Bar.....	82	Schlage®.....	112
Panel, 1-7/16" Beaded V-Groove DHRP.....	24	Ponderosa Pine.....	84	Custom Doors.....	118
Panel, V-Groove Plank.....	25	Panel, 1-7/16" DHRP.....	84	Index.....	122
Panel, 1-1/4" DHRP.....	26	Sash, 1-7/16" DHRP.....	85	Unit Dimensions &	
Panel, 3/4" DHRP.....	28	Panel, 3/4" SHRP.....	86	Rough Openings.....	132
Sash, 1-7/16" DHRP.....	30	Sash, 1-5/16" TDL Bar, 1-3/16" DHRP.....	87	Education.....	134
Sash, 1-7/16" DHRP, Santa Fe Glass.....	34	French.....	90	Care & Finishing.....	136
Sash, 3/4" DHRP.....	35	French, 1-5/16" TDL Bar.....	91	Other Products.....	138
Sash, 3/4" Flat Panel.....	36	Red Oak.....	92		
Sash, 3/4" Flat Panel, Solano® Glass.....	38	Panel, 1-7/16" DHRP.....	92		
Sash, 7/8" SDL Bar, 1-7/16" DHRP.....	40	Sash, 1-3/8" SDL Bars, 1-7/16" DHRP.....	93		
Sash, 1-3/8" SDL Bar, 1-7/16" DHRP.....	46	Combination Door & Screen Doors.....	94		
Sash, 1-3/8" SDL Bar, 1-7/16" Beaded V-Groove DHRP.....	48	Anatomy of an Exterior Door.....	96		
Sash, 2-3/4" TDL Bar, 1-7/16" DHRP.....	51	Door Unit Configurations.....	97		
Sash, 1-1/4" TDL Bar, 3/4" DHRP.....	52	Door Handing.....	97		
Sash, 2-3/4" TDL Bar, 3/4" Flat Panel.....	54	Frames.....	98		
Sash, 1-3/8" TDL Bar, 3/4" Flat Panel.....	55				

DHRP - Double Hip Raised Panel
SHRP - Single Hip Raised Panel

SDL - Simulated Divided Lite
TDL - True Divided Lite

Why Choose Reeb?



Fast Lead Times.

Reeb has 5 East Coast warehouses and two high-speed pre-finishing plants, all capable of operating as one cohesive unit when production levels increase; keeping lead times low and product availability high.



Large Inventory.

Reeb has an extensive inventory of stile and rail doors in a variety of designs and options to help homeowners create the look they desire for their home.



Door Unit Components.

In addition to a large door inventory, Reeb stocks all the components necessary to create a pre-hung door unit – including frames, sills, and hinges.



Quality Service.

Reeb's Customer Service and Field Service departments are dedicated to providing high quality service to each of our customers.



Education.

Reeb provides door education through our in-stock catalogs and a guided selling showroom, while our online Reeb Learning Center helps customers choose the right product for their needs.

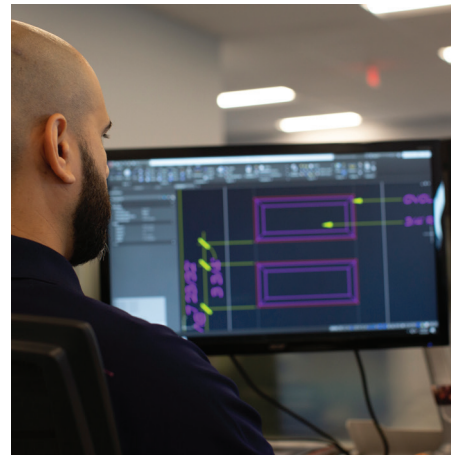

Customization.

Reeb's Custom Department can help to create a unique door for any home. The possibilities are endless from the layout of the panels, to the wood species, to the pattern of the glass, to the shape and size of the door.

Why Buy A Wood Door?

One of the many attractions of a wood door is that every door is completely unique. From their unlimited flexibility in design to their natural grain patterns, no two wood doors are ever the same. Whether you're looking to stain or paint your door, the beautiful look of real wood shows through and creates a truly memorable impression.

The stiles and the rails provide details that you will not find in any alternative products. Wood doors are made from many different components that can be joined together to make really interesting custom designs and sizes. From a sticking with crisp lines to a sharp panel raise, wood doors are unique.

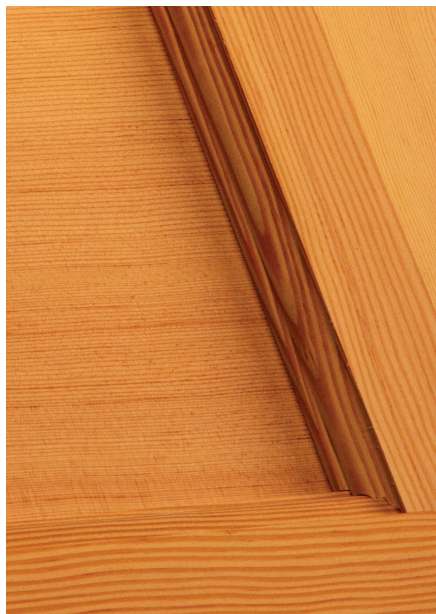

Flat Panel
Ovolo Sticking
Shown in Douglas Fir



Single Hip Raised Panel
Ovolo Sticking
Shown in Ponderosa Pine



Double Hip Raised Panel
Ovolo Sticking
Shown in Sapele Mahogany



Double Hip Raised Panel
w/ Raised Moulding
Ovolo Sticking
Shown in Sapele Mahogany



Glass
Shaker Sticking
Shown in Douglas Fir



Glass
Ovolo Sticking
Shown in Sapele Mahogany

Why Buy a Wood Door?

Wood Door Styles and Construction Methods

When choosing a wood door, there are many considerations. For the highest level of privacy, you can get a panel door which has no glass. If you want to bring light into your home you can either get a sash door which pairs a piece of glass with panels or you can get a french door which allows in the most natural light. In addition to privacy and light, there are different layout options for the door. Architecturally correct doors have proportional stiles and rails while wide layout doors have larger 5-1/2" stiles to accommodate certain locking mechanisms. Reverse layout doors switch the intermediate and bottom panels, as well as lock rail and bottom rail, for a different look.



Panel



Sash



French



Architecturally Correct



Wide Layout



Reverse Layout

Solid wood doors provide all of the benefits that go along with real wood. Solid wood components join together to create ultimate strength and durability, while other non-wood products in the industry are filled with foam. Solid wood does not offer the best insulation values, but it is warm to the touch and does reduce sound transmission. So why buy a wood door? First of all, wood products are the real deal, not just another imitation product. Wood doors provide beauty, strength, and durability for a door that's going to last a lifetime.



F6803 w/ Dentil Shelf
in Douglas Fir
See Page 55 for details

Door Durability

Knowing the durability of your door is important when it comes to moisture management. Moisture affects a door and causes it to warp or rot over time. Reeb stocks three durability levels – good, better, and best.



Good Durability

Doors with a good level of durability look like solid wood, but they are a number of blocks glued together, covered with a veneer. Whether it's the stile or the rail, we can see these different parts, which are solid, but not solid lumber, and the product is glued together only at the dowel pins. These parts and pieces take on moisture at different rates, causing the door to open up and swell. More moisture can get in causing veneer delamination, stile and rail separation, and eventually rot.

Better Durability

Doors with a better level of durability have a core covered with a veneer, but also have a composite block on the bottom of the stile. This block of composite material stops any water from being able to get into the stile making for a much tougher door. The bottom rail, the most vulnerable part of this door, is solid lumber; there is no core and no finger joints. The stile and rails are glued together at the dowel pins, but instead of just being glued at the dowel pins, this whole surface area of the stile and rail joint is covered with glue. It does two things: it makes a tough joint, and the glue gets into the open end grain of the solid lumber bottom rail and helps seal it up.



Best Durability

Doors with the best level of durability are the toughest wood doors and are constructed in one of three ways. The construction of the better door can be taken up a level by adding a medium density overlay over the entire exterior of the door. This MDO stops water to make the door durable in any application. The other two doors with the best durability are solid lumber – no veneers, no edge strips, and no core.

Two boards are face glued together to keep the door rigid and stable and resists warping and bowing. One solid lumber door has its stile and rail joints held together with dowel pins and glued at the cope. The other solid lumber door has a massive mortise cut into the stiles and rails. Those components have glue applied along the cope and are joined by a tenon. Face pins are applied through the door and tenon to hold that joint together forever.

Wood doors look really similar but their different construction techniques dictate the durability level of the door. Durability is also directly related to the exposure of your home and what warranty your door will have. It's important to buy the very best quality product that's the most durable for the best return on investment. For more information on exposure types, see page 8.

Exposure Types

Many homes have a covering over their front door also known as an overhang. Depending on the size of the overhang, your door may be partially or fully exposed to the elements. In these cases, it is important to consider the durability and construction of the door to make sure it stands up to the elements. Doorways can be grouped into three different protection levels: fully protected, partially protected, and unprotected.



F77130 in Douglas Fir
See Page 21 for details



F77465 in Douglas Fir
See Page 21 for details

Fully Protected Doorway

Fully Protected Doorways provide the most protection for your doorway. The overhang extends the same distance as the unit is high but it also extends past the door on the sides to cover all angles of the door. Rain and snow may come in at an angle and with this type of doorway, the door will be protected from the elements.

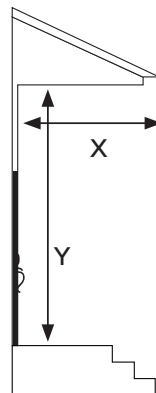

Partially Protected Doorway

Partially Protected Doorways provide protection for the top half of the door, but many times the bottom half is exposed to the elements. This is the portion of the door that is susceptible to water and moisture or the sun can break down the finishing seal over time by baking the bottom half of the door. The height of the opening is the distance from the sill to the ceiling.

The overhang (X) of a partially protected doorway must extend half of the height (Y) distance ($X = 1/2 Y$). If you have a height (Y) of 10 feet, the overhang of a partially protected doorway must come out 5 feet (X).



Unprotected Doorway

Unprotected Doorways provide no protection from the weather. The overhang of these units either do not exist or only come out a small distance. If the height of the unit is 10 feet, then the overhang will come out less than half of the height. The smaller overhang provides less protection for the top of the door creating a need for a more durable overall door. Most homes have at least one unprotected doorway so it's important to choose a door with the best durability level to provide maximum protection from the elements.

Exposure and Durability

Once you understand the protection level of your doorway, use the chart below to know which durability will work best in your doorway. Throughout the catalog, the doors are labeled as good durability, better durability, or best durability to help you choose a door that will work in your exposure type but also last a lifetime. For more about durability, see page 7.



	GOOD DURABILITY	BETTER DURABILITY	BEST DURABILITY
Fully Protected Doorway	✓	✓	✓
Partially Protected Doorway		✓	✓
Unprotected Doorway			✓



Simpson® Nantucket® Collection doors are the toughest wood doors available.

All the components of the Nantucket door are solid wood. The stiles and rails utilize a two-piece laminated construction, resulting in a straighter and more stable stile.

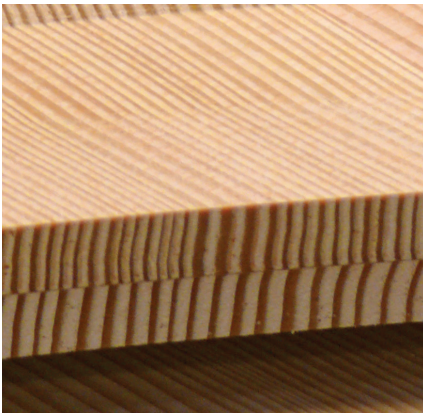

Innerbond® panels are created with offsetting grain patterns to provide extra strength to resist warping and splitting.



The Nantucket® door is joined with a modified mortise-and-tenon. A large mortise is cut into both the stile and rail.



Glue is added to the mortise of the stile and a tenon is inserted.

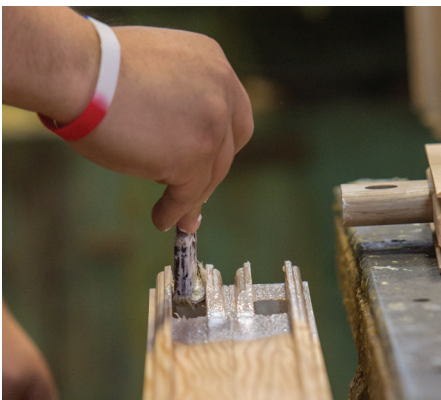

Additional glue is added to the stile and along the entire coped area.



Then the stiles and rails are assembled together.



A wood pin is driven into the face of the door to join the components together. The result is a unique beauty and durability that is only found in the Nantucket Collection.

In addition to advanced durability they have exquisite detail and feature a flat or double hip raised panel and have the choice to include a variety of glass options.



Flat Panel



Raised Panel

Made from wood that is naturally moisture-resistant, Nantucket® doors are stocked by Reeb in 2 species: Douglas Fir and Sapele Mahogany.

They feature a 10 year limited warranty and can be used in any exposure with no overhang required.



Douglas Fir

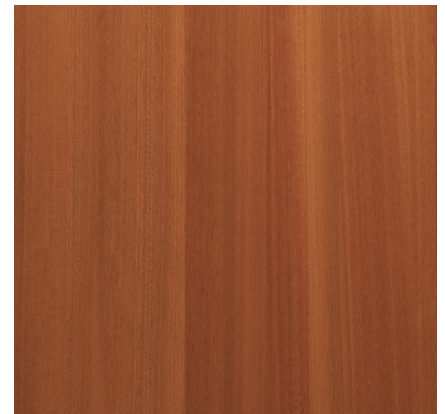

Sapele Mahogany



F77212 in Douglas Fir
See Page 41 for details

The Nantucket® Collection features the best durability possible with an unmatched character that can only be found in real wood. These doors will retain their rugged beauty and last for years, regardless of what nature sends their way. You can find Nantucket doors on pages 21, 41, 54, 57, 60, 64, 75, 79 and 82.



All the components of the **Metropolitan™** door are solid wood. The stiles and rails utilize a two-piece laminated construction, resulting in a straighter and more stable stile.

Innerbond® panels are created with offsetting grain patterns to provide extra strength to resist warping and splitting.

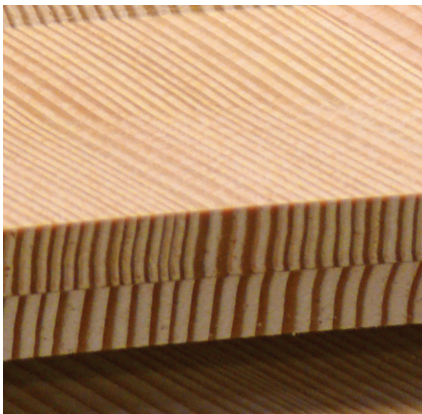

Innerbond® panels are created with offsetting grain patterns to provide extra strength to resist warping and splitting.



The stile and rails are joined by dowel pins.



They feature the Weather Seal™ process along the area where the stiles and rails meet, blocking water absorption and enhancing the glue joints.

The Metropolitan's joinery replaces the face pin with a traditional dowel pin for a minimalistic look. This joinery does not compare to the Nantucket's joint strength, but the door is still capable of being used in any exposure.



Nantucket



Metropolitan

In addition to advanced durability they have exquisite detail and feature a double hip raised panel.

Some styles include a raised moulding applied on one side for an additional design element.



Raised Panel



Raised Moulding

Made from wood that is naturally moisture-resistant, Metropolitan™ doors are stocked by Reeb in 2 species: Douglas Fir and Sapele Mahogany which feature a 5 year limited warranty. They can be used in any exposure with no overhang required.

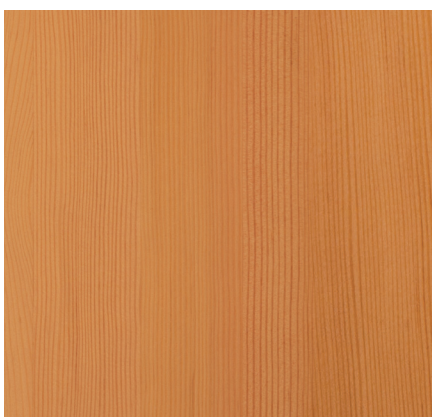

Douglas Fir

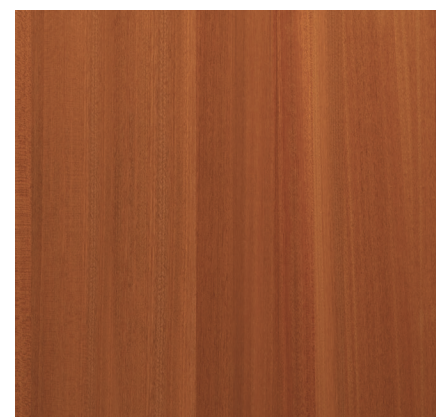

Sapele Mahogany



The Metropolitan Series features the best durability allowing these doors to be in any exposure. You can find Metropolitan doors on pages 23, 75..



Simpson® Performance Series® doors include components that provide additional protection to your door in harsh weather conditions. Performance Series doors utilize three moisture blocking features.

First, they utilize UltraBlock® Technology which is a water-resistant composite block added to the bottom of both door stiles.



Second, they feature the Weather Seal process. The sides of the rails are covered with glue.



Additional glue is also added to the holes for the dowels pins.



Including glue where stiles and rails meet blocks water absorption and enhances the glue joints.



Finally, all Simpson Performance Doors stocked by Reeb come with a solid bottom rail. Solid lumber is very durable especially in this vulnerable area of the door. By incorporating all three of these into a door, the entire bottom of the door is protected against moisture penetration.

Reeb stocks Performance Doors in Douglas Fir, Sapele Mahogany, Ponderosa Pine, and Red Oak; they come with a 5 year limited warranty in a partially protected doorway.

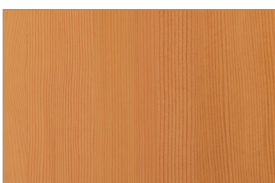

DOUGLAS FIR

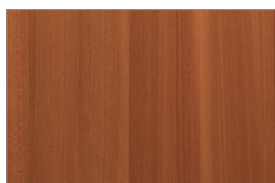

SAPELE MAHOGANY

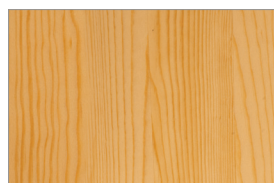

PONDEROSA PINE

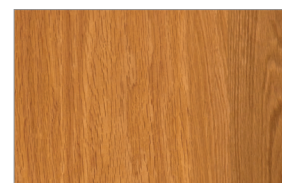

RED OAK



Included as part of the Performance Series® doors is the **WaterBarrier® Series**. WaterBarrier doors include a Primed Medium Density Overlay (MDO) which is a material that covers the flat exterior portions of the door.

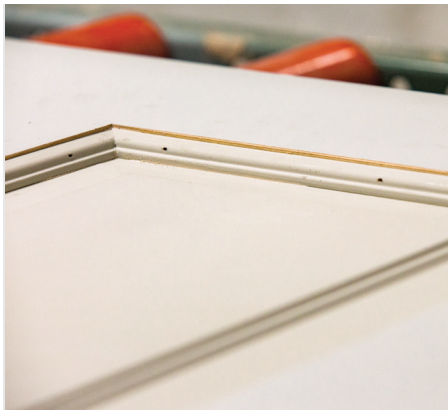

Innerbond double hip raised panels are covered with a water-resistant primer.

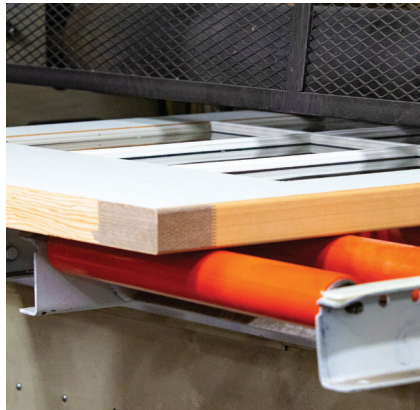

Water resistant glazing beads and bars are used to create an exterior that stops water in its tracks.

WaterBarrier technology can be used on virtually any species to receive the highest protection on the exterior of the door while getting the unmatched beauty of a real wood door on the inside. WaterBarrier doors are stocked by Reeb in Fir.



WaterBarrier® with Low-E Glass - Exterior Side



Interior Side (in Douglas Fir)

The Performance Series® takes an amazing wood door crafted with impeccable details and gives it three layers of security creating a door with better durability. By also incorporating WaterBarrier® technology the door is created with the best durability that is suited for the toughest exposures. Beauty is important in any door, but a beautiful door is only worth having if it lasts. You can find WaterBarrier® doors on pages 30-31, 42-43, 61 and 65.

For more information on the Performance Series visit learn.reeb.com/simpson-performance-series-doors/



Standard construction wood doors have a veneer over a finger-jointed core making it very susceptible to moisture especially in a partially or unprotected doorway.



The stile and rail joints are joined by dowel pins but are only glued at the dowels, not at the coped area.



Water can get through the coped area because it is not sealed by the glue. Once moisture begins to get through the coped area, it can lead to moisture infiltration, door swelling, and eventually rot and decay as well as veneer delamination.



Doors with this joinery have only a good durability and should only be used in Fully Protected Doorways.

Wood Species

Reeb® stocks a variety of wood species to match any home's design. Staining a door brings a layer of beauty and sophistication to an area. Each species has different characteristics, colors, and grain patterns which affect the stain application. To help understand which doors stain well, Reeb has created icons which identify the stainability of a species.



DOUGLAS FIR

PAGES 20-73



SAPELE MAHOGANY

PAGES 74-83

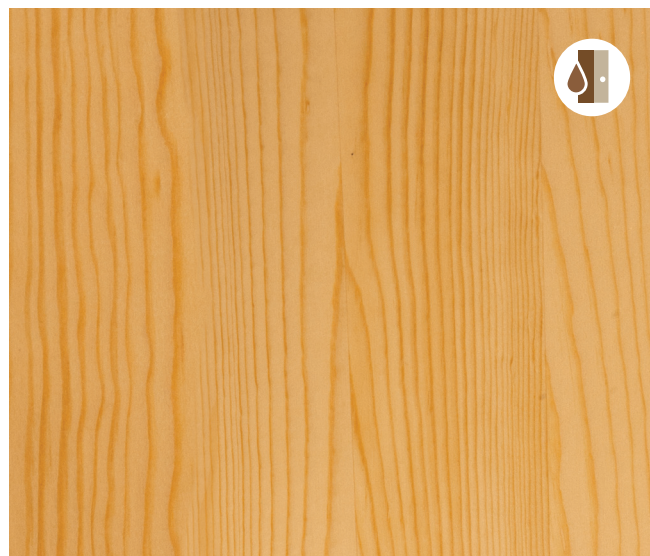

PONDEROSA PINE

PAGES 84-91



RED OAK

PAGES 92-93

Reeb's in-stock collection of exterior doors include the species shown on this page, however there is a broad range of wood species available. You can choose from the satin texture of Cherry, the chocolate-brown coloring of Walnut, or the textile-like surface appearance of Bamboo plus many more. If you are interested in another species type, it is likely that we can help.

To see Simpson's wood selector tool visit

<https://www.simpsondoor.com/doormagination-design-tools/wood-options/>

Glass Options

Glass is an excellent way to bring natural light into any home. Most exterior door products utilize insulated glass. Also known as a double-pane glass, insulated glass consists of two panes of glass separated by an air pocket. This type of glass helps to reduce heat transfer across the door. Single Pane Glass is only one layer of glass and is typical of standard construction doors.

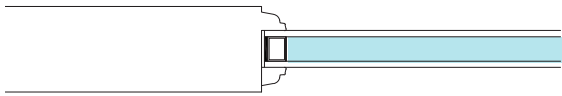

Double Pane Glass

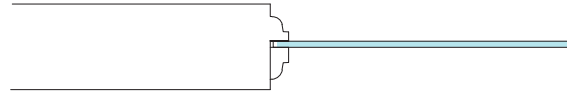

Single Pane Glass

There are two types of divided lites: True Divided Lites (TDL) and Simulated Divided Lites (SDL). Doors with TDLs feature individual pieces of glass divided by muntin bars. They can utilize either single pane or double pane glass. Doors with SDLs are a single piece of double pane glass with bars applied to the glass surface. Many doors that utilize SDL Bars will also have a spacer bar in between for a more authentic look.

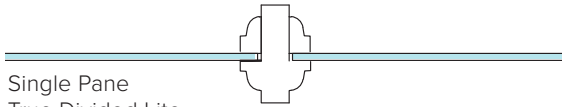

Single Pane
True Divided Lite

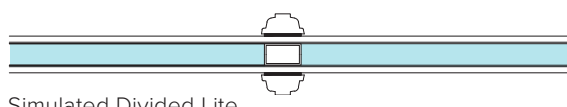

Simulated Divided Lite

Reeb® offers the option to apply SDL bars without an internal shadow spacer allowing for customized looks.



7/8" SDL Bar in Douglas Fir



7/8" SDL Bar in Sapele Mahogany

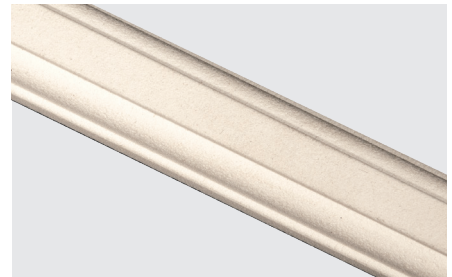

7/8" SDL Bar in PVC



1-3/8" SDL Bar in Douglas Fir



1-3/8" SDL Bar in Sapele Mahogany



1-3/8" SDL Bar in PVC

Custom Lite Designs

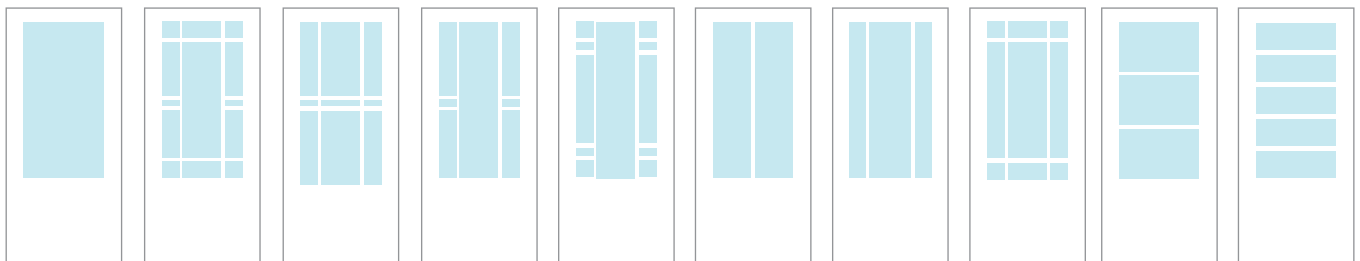

Choose from one of the designs below or contact Reeb for a custom design. See page 130 for more about Custom Doors.

Glass Types

Clear glass is a common option for exterior doors as it lets the most possible natural light into a home. Insulated glass, as explained on the previous page, is two panes of glass which are both tempered. Low-E glass is also clear, however gives additional energy savings by keeping the heat in during the winter months and the heat out in the summer.

Textured glass adds another level of design and privacy to your front door. Beveled glass is clear glass with a bevel to the edge for a design flair. Satin Etch is a semi-opaque glass with an etched frost texture that resists fingerprint and dust impressions. White Laminate is an opaque white glass that allows light in while providing the highest privacy.

Decorative glass brings intricate designs and reflects meticulous attention to detail. Available with black coming or wrought iron, doors with decorative glass bring a level of sophistication to any home.



BEVELED GLASS

PAGE 50

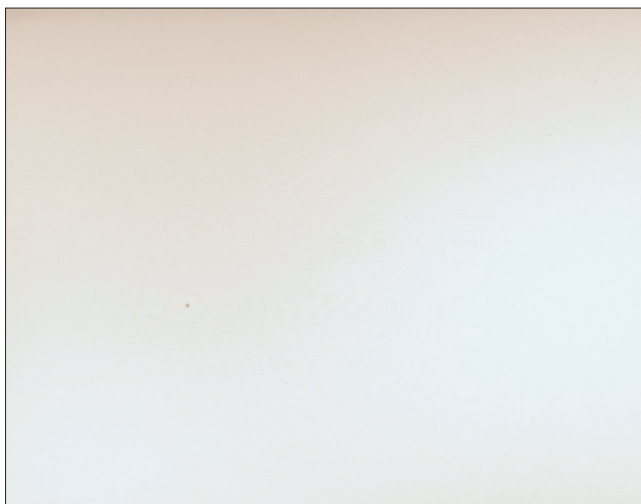

SATIN ETCH GLASS

PAGE 58

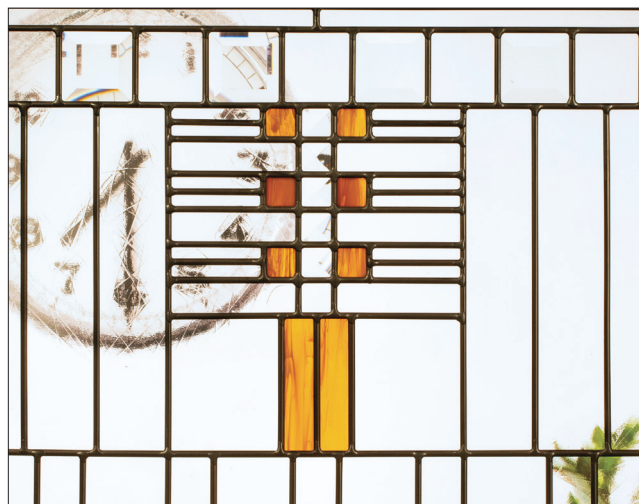

SOLANO® III GLASS

PAGE 38



TERRACE RIDGE® GLASS

PAGE 63

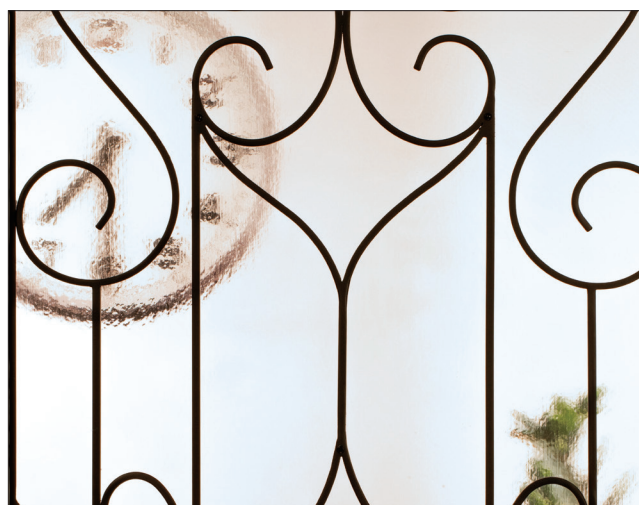

SANTA FE GLASS

PAGE 34

While the glass styles shown here are our in-stock options, there are many more textured and decorative glass options available. Visit <https://www.simpsondoor.com/doormagination-design-tools/glass-options/> to see Simpson's Glass Taste Test.

Douglas Fir

PANEL DOORS 1-7/16" DOUBLE HIP RAISED PANEL



Nantucket® 1-7/16" Double Hip Raised Panel



Nantucket® Door Corner

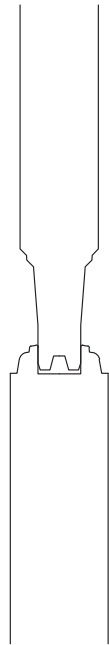

Panel Profile



F77144, Simpson

NANTUCKET® BEST DURABILITY



F77465
 1-7/16" Double Hip
 Raised Panel
 Ovolo Sticking
 Wide Layout
 3/0 x 6/8



F77144
 1-7/16" Double Hip
 Raised Panel
 Ovolo Sticking
 Wide Layout
 3/0 x 6/8



F77130
 1-7/16" Double Hip
 Raised Panel
 Ovolo Sticking
 Wide Layout
 3/0 x 6/8



Douglas Fir

PANEL DOORS 1-7/16" DOUBLE HIP RAISED PANEL



Performance 1-7/16" Double Hip Raised Panel



Metropolitan™ Door Corner

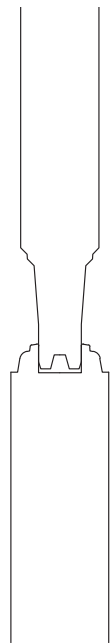

Panel Profile



Performance Door Corner

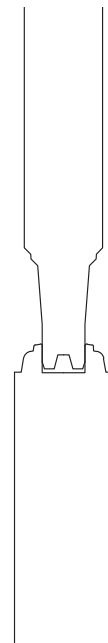

Panel Profile

METROPOLITAN™ BEST DURABILITY



MF7282*
 1-7/16" Double Hip
 Raised Panel
 Wide Layout
 Ovolo Sticking
 2/8 x 6/8 2/8 x 8/0
 3/0 x 6/8 3/0 x 8/0



MF7465
 1-7/16" Double Hip
 Raised Panel
 Wide Layout
 Ovolo Sticking
 2/8 x 6/8 2/8 x 8/0
 3/0 x 6/8 3/0 x 8/0



MF7467
 1-7/16" Double Hip
 Raised Panel
 Wide Layout
 Ovolo Sticking
 2/8 x 6/8
 3/0 x 6/8



MF7466
 1-7/16" Double Hip
 Raised Panel
 Wide Layout
 Ovolo Sticking
 2/8 x 6/8
 3/0 x 6/8

PERFORMANCE BETTER DURABILITY



MF7230*
 1-7/16" Double Hip
 Raised Panel
 Wide Layout
 Ovolo Sticking
 2/8 x 6/8 2/8 x 8/0
 3/0 x 6/8 3/0 x 8/0



MF7701
 Low-E
 Ovolo Sticking
 1/0 x 6/8 1/0 x 8/0
 1/2 x 6/8 1/2 x 8/0



*Optional Raised Moulding on 1 Side



F7130
 1-7/16" Double Hip
 Raised Panel
 Wide Layout*
 Ovolo Sticking
 2/0 x 6/8 2/0 x 7/0 3/0 x 8/0*
 2/4 x 6/8 2/4 x 7/0
 2/6 x 6/8 2/6 x 7/0
 2/8 x 6/8* 2/8 x 7/0*
 3/0 x 6/8* 3/0 x 7/0*

*These doors are able to include Raised Moulding on the Exterior side (RE) or on the Interior side (RI) of the door.

Douglas Fir

PANEL DOORS 1-7/16" BEADED V-GROOVE DOUBLE HIP RAISED PANEL



Performance 1-7/16" Beaded V-Groove Double Hip Raised Panel



Performance Door Corner (top)

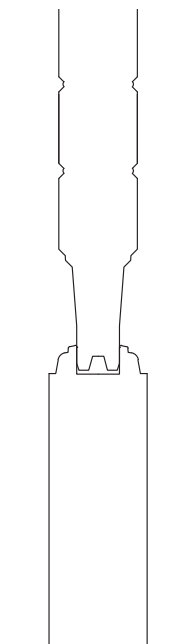

Panel Profile
(viewed from above)

PERFORMANCE BETTER DURABILITY



F7304
1-7/16" Beaded V-Groove
Double Hip Raised Panel
Wide Layout, Ovolo Sticking

2/8 x 6/8 2/8 x 7/0 3/0 x 8/0
3/0 x 6/8 3/0 x 7/0



F7326
1-7/16" Beaded V-Groove
Double Hip Raised Panel
Wide Layout, Ovolo Sticking

2/8 x 6/8
3/0 x 6/8

PANEL DOORS V-GROOVE PLANK



Standard V-Groove Plank



Standard Door Corner (top)

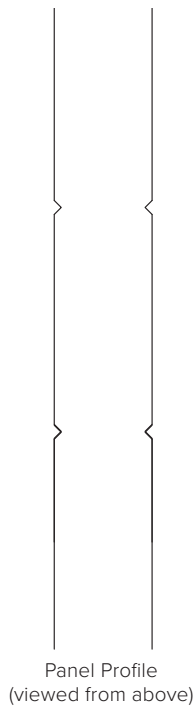

STANDARD GOOD DURABILITY



F4416V
V-Groove Plank
2/8 x 6/8 3/0 x 7/0
3/0 x 6/8

Douglas Fir

PANEL DOORS 1-1/4" DOUBLE HIP RAISED PANEL



Performance 1-1/4" Double Hip Raised Panel, Raised Moulding 1 Side



Performance Door Corner

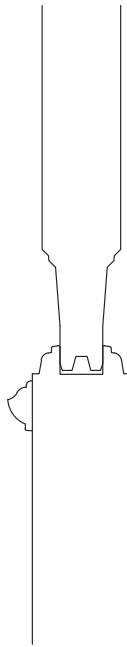

Panel Profile

Due to the raised moulding applied on the exterior, not all handlesets will work.



F3044
1-1/4" Double Hip
Raised Panel
Raised Moulding 1 Side
Ovolo Sticking
3/0 x 6/8



F3130
1-1/4" Double Hip
Raised Panel
Raised Moulding 1 Side
Ovolo Sticking
3/0 x 6/8



F3010
1-1/4" Double Hip
Raised Panel
Raised Moulding 1 Side
Ovolo Sticking
3/0 x 6/8



Douglas Fir

PANEL DOORS 3/4" DOUBLE HIP RAISED PANEL



Standard 3/4" Double Hip Raised Panel



Standard Door Corner

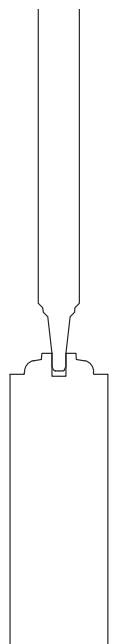

Panel Profile

STANDARD GOOD DURABILITY



F2044
3/4" Double Hip
Raised Panel
Ovolo Sticking

2/6 x 6/8
2/8 x 6/8
3/0 x 6/8



F2055, Simpson

STANDARD GOOD DURABILITY



F2055
 3/4" Double Hip
 Raised Panel
 Ovolo Sticking
 2/6 x 6/8 2/6 x 7/0
 2/8 x 6/8 2/8 x 7/0
 3/0 x 6/8 3/0 x 7/0



F2130
 3/4" Double Hip
 Raised Panel
 Ovolo Sticking
 2/6 x 6/8 2/6 x 7/0
 2/8 x 6/8 2/8 x 7/0
 3/0 x 6/8 3/0 x 7/0



F2010
 3/4" Double Hip
 Raised Panel
 Ovolo Sticking
 2/8 x 6/8
 3/0 x 6/8



F2060
 3/4" Double Hip
 Raised Panel
 Ovolo Sticking
 3/0 x 6/8

Douglas Fir

SASH DOORS 1-7/16" DOUBLE HIP RAISED PANEL



WaterBarrier® 1-7/16" Double Hip Raised Panel with Low-E Glass - Exterior Side



WaterBarrier® Door Corner

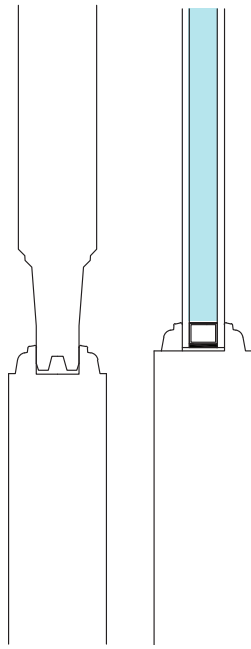

Panel Profile

Glass Profile



1-7/16" Double Hip Raised Panel - Interior Side



F7044LEW, Simpson

WATERBARRIER® BEST DURABILITY



F7081LEW

Low-E
1-7/16" Double Hip
Raised Panel
Wide Layout
Ovolo Sticking

2/8 x 6/8 2/8 x 7/0
3/0 x 6/8 3/0 x 7/0



F7044LEW

Low-E
1-7/16" Double Hip
Raised Panel
Wide Layout
Ovolo Sticking

2/8 x 6/8 2/8 x 7/0
3/0 x 6/8 3/0 x 7/0



F7501LEW

Low-E
1-7/16" Double Hip
Raised Panel
Wide Layout
Ovolo Sticking

2/8 x 6/8 2/8 x 7/0
3/0 x 6/8 3/0 x 7/0



F7801LEW

Low-E
1-7/16" Double Hip
Raised Panel
Ovolo Sticking

1/0 x 6/8 1/0 x 7/0
1/2 x 6/8 1/2 x 7/0

Douglas Fir

SASH DOORS 1-7/16" DOUBLE HIP RAISED PANEL



Performance 1-7/16" Double Hip Raised Panel with IG Glass



Performance Door Corner

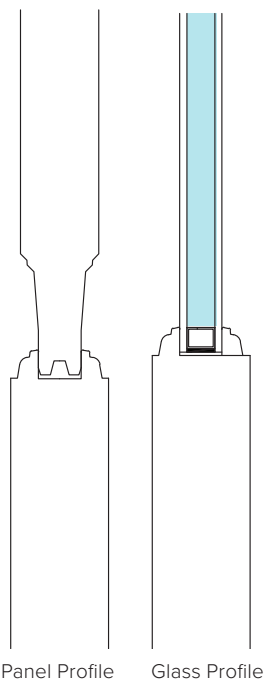

PERFORMANCE BETTER DURABILITY



F7044LE

Low-E
1-7/16" Double Hip
Raised Panel
Ovolo Sticking

2/6 x 6/8 3/0 x 8/0
2/8 x 6/8
3/0 x 6/8

F7702

IG
1-7/16" Double Hip
Raised Panel
Ovolo Sticking

1/0 x 6/8 1/0 x 8/0 (LE)
1/2 x 6/8 1/2 x 8/0 (LE)



F7031LE, Simpson

PERFORMANCE BETTER DURABILITY



F7031LE
 Low-E
 1-7/16" Double Hip
 Raised Panel
 Ovolo Sticking
 2/8 x 6/8
 3/0 x 6/8



F7501LE
 Low-E
 1-7/16" Double Hip
 Raised Panel
 Wide Layout
 Ovolo Sticking
 2/6 x 6/8 2/6 x 8/0
 2/8 x 6/8 2/8 x 8/0
 3/0 x 6/8 3/0 x 8/0

F7801LE
 Low-E
 1-7/16" Double Hip
 Raised Panel
 Ovolo Sticking
 1/0 x 6/8 1/0 x 8/0
 1/2 x 6/8 1/2 x 8/0



F7132
 IG
 1-7/16" Double Hip
 Raised Panel
 Wide Layout*
 Ovolo Sticking
 2/6 x 6/8 2/6 x 7/0
 2/8 x 6/8* 2/8 x 7/0*
 3/0 x 6/8* 3/0 x 7/0*



Douglas Fir

SASH DOORS SANTA FE DECORATIVE GLASS & 1-7/16" DOUBLE HIP RAISED PANEL



Performance 1-7/16" Double Hip Raised Panel with Santa Fe Wrought Iron Glass

PERFORMANCE BETTER DURABILITY



Performance Door Corner

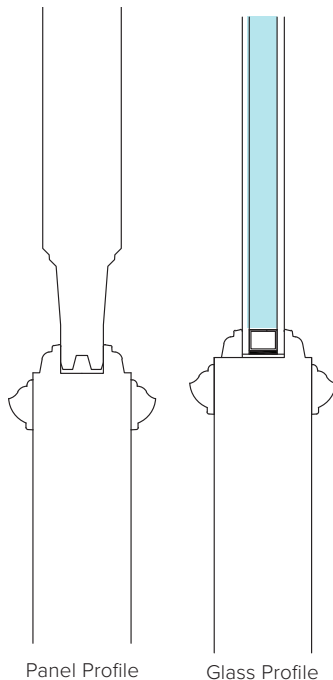

Panel Profile

Glass Profile



F6490

IG
Wrought Iron
1-7/16" Double Hip
Raised Panel
Wide Layout
Raised Moulding 2 Sides
Ovolo Sticking
3/0 x 6/8
3/0 x 7/0



F6493

IG
Wrought Iron
1-7/16" Double Hip
Raised Panel
Wide Layout
Raised Moulding 2 Sides
Ovolo Sticking
1/0 x 6/8 1/0 x 7/0

SASH DOORS 3/4" DOUBLE HIP RAISED PANEL



Standard 3/4" Double Hip Raised Panel

STANDARD GOOD DURABILITY



Standard Door Corner

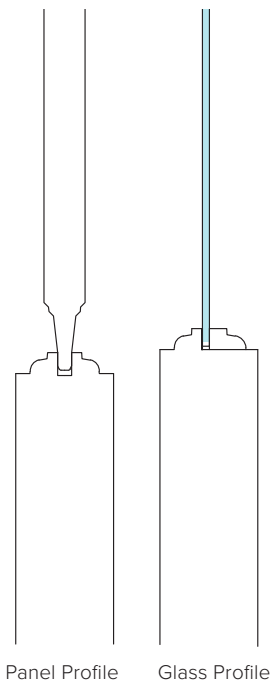

F2132
 Single Pane
 Safety Glass
 3/4" Double Hip
 Raised Panel
 Ovolo Sticking
 2/8 x 6/8 3/0 x 7/0
 3/0 x 6/8

Douglas Fir

SASH DOORS 3/4" FLAT PANEL

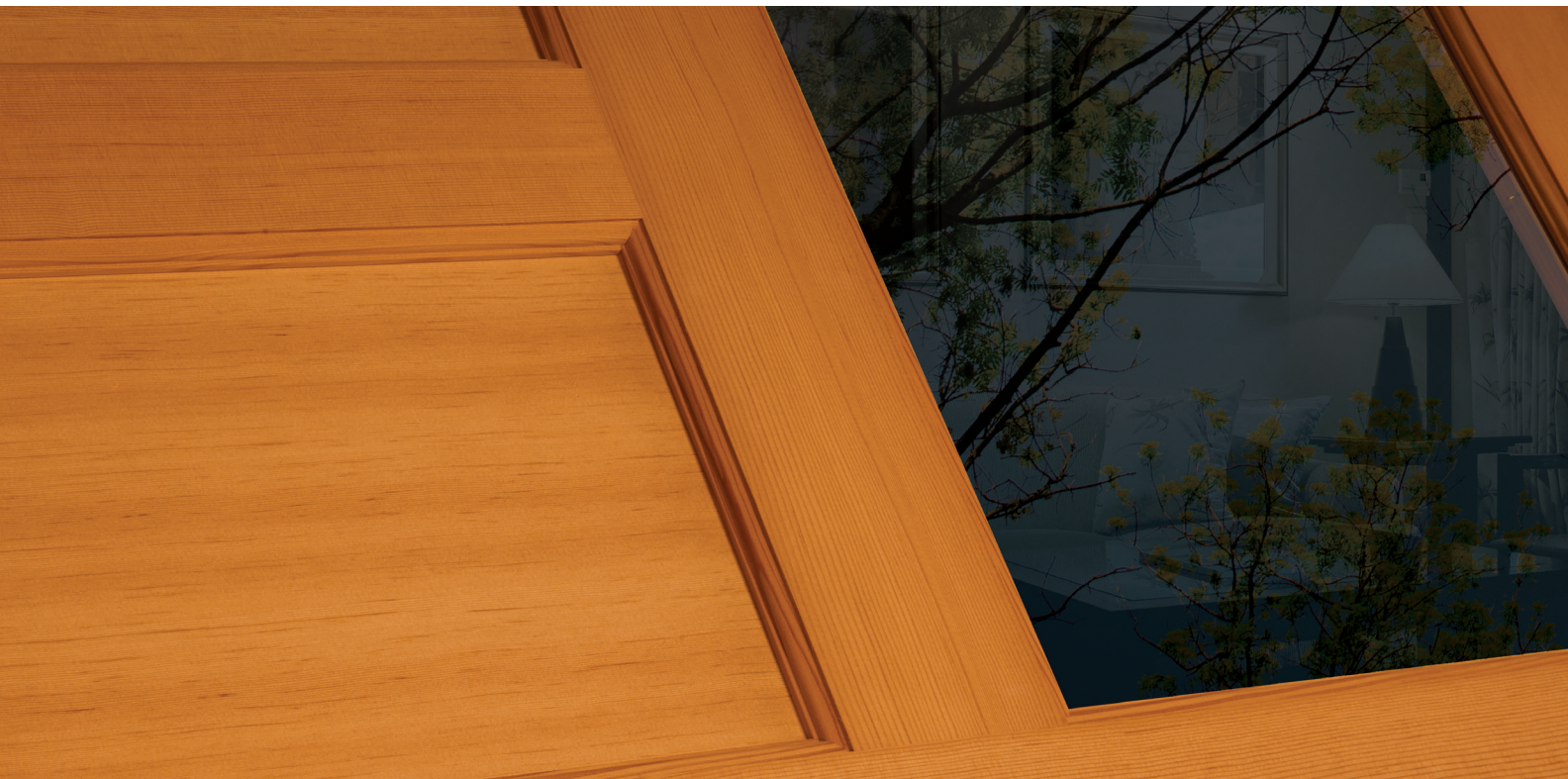

Performance 3/4" Flat Panel with IG Glass

PERFORMANCE BETTER DURABILITY



Performance Door Corner

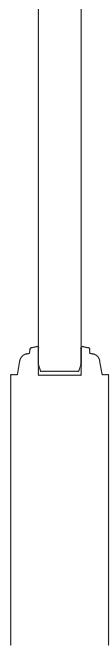

Panel Profile

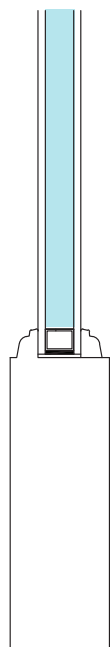

Glass Profile



F6801LE
Low-E
3/4" Flat Panel
Wide Layout
Ovolo Sticking
3/0 x 6/8
3/0 x 8/0



F6175LE
Low-E
3/4" Flat Panel
Ovolo Sticking
1/0 x 6/8
1/2 x 6/8



F6861LE
 Low-E
 3/4" Flat Panel
 Ovolo Sticking
 3/0 x 6/8
 3/0 x 8/0



F6801
 IG
 3/4" Flat Panel
 Wide Layout
 Ovolo Sticking
 3/0 x 6/8
 3/0 x 8/0

F6175
 IG
 3/4" Flat Panel
 Ovolo Sticking
 1/0 x 6/8
 1/2 x 6/8



F6861
 IG
 3/4" Flat Panel
 Ovolo Sticking
 3/0 x 6/8
 3/0 x 8/0



F6861 (door), **F6175** (sidelite), Simpson
 Unit shown is custom stained

Douglas Fir

SASH DOORS SOLANO® III DECORATIVE GLASS & 3/4" FLAT PANEL



Performance 3/4" Flat Panel with Solano Decorative Glass



Performance Door Corner

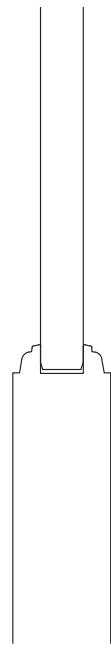

Panel Profile

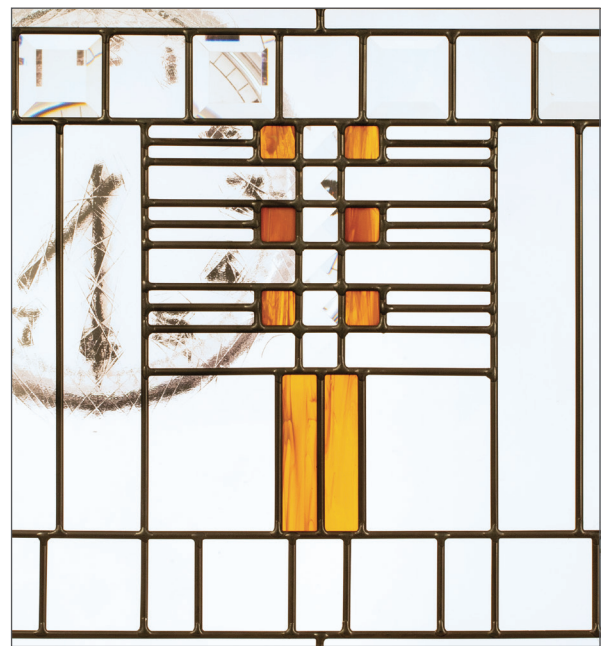

Solano® III Glass with Black Caming Close-up



F6841
Black Caming IG
3/4" Flat Panel
Wide Layout
Ovolo Sticking
3/0 x 6/8
3/0 x 8/0



F6171
Black Caming IG
Ovolo Sticking
1/0 x 6/8
1/2 x 6/8



F6881
Black Caming IG
3/4" Flat Panel
Ovolo Sticking
3/0 x 6/8
3/0 x 8/0



F6841, Simpson

Douglas Fir

SASH DOORS 7/8" SDL BAR & 1-7/16" DOUBLE HIP RAISED PANEL



Nantucket® 7/8" SDL Bar, 1-7/16" Double Hip Raised Panel with Low-E Glass



Nantucket® Door Corner



Panel Profile

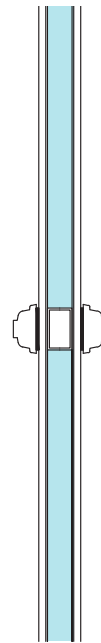

Glass Profile



F77662

Low-E
7/8" SDL Bar
1-7/16" Double Hip
Raised Panel
Ovolo Sticking
Wide Layout
3/0 x 6/8

F77663RP

Low-E
7/8" SDL Bar
1-7/16" Double Hip
Raised Panel
Ovolo Sticking
1/2 x 6/8



F77944

Low-E
7/8" SDL Bar
1-7/16" Double Hip
Raised Panel
Ovolo Sticking
Wide Layout
2/8 x 6/8
3/0 x 6/8

F77703

Low-E
7/8" SDL Bar
1-7/16" Double Hip
Raised Panel
Ovolo Sticking
1/2 x 6/8



F77212

Low-E
7/8" SDL Bar
1-7/16" Double Hip
Raised Panel
Ovolo Sticking
Wide Layout
3/0 x 6/8

F77804

Low-E
7/8" SDL Bar
1-7/16" Double Hip
Raised Panel
Ovolo Sticking
1/2 x 6/8



F77598

Low-E
7/8" SDL Bar
1-7/16" Double Hip
Raised Panel
Ovolo Sticking
Wide Layout
2/8 x 6/8
3/0 x 6/8

F77599

Low-E
7/8" SDL Bar
1-7/16" Double Hip
Raised Panel
Ovolo Sticking
1/2 x 6/8

Douglas Fir

SASH DOORS 7/8" SDL BAR & 1-7/16" DOUBLE HIP RAISED PANEL



WaterBarrier® 7/8" SDL Bar, 1-7/16" Double Hip Raised Panel with Low-E Glass - Exterior Side



WaterBarrier® Door Corner

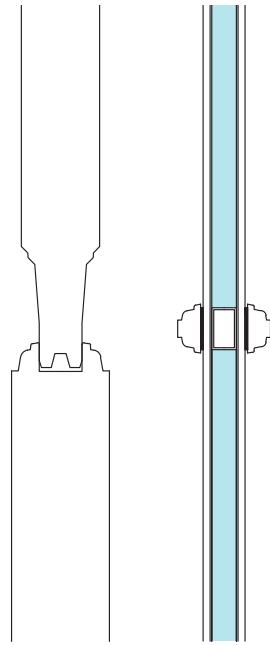

Panel Profile

Glass Profile



1-7/16" Double Hip Raised Panel - Interior Side



WATERBARRIER® BEST DURABILITY



F37662LEW
 Low-E
 7/8" SDL Bar
 1-7/16" Double Hip
 Raised Panel
 Wide Layout
 Ovolo Sticking
 3/0 x 6/8



F37663LEW
 Low-E
 7/8" SDL Bar
 1-7/16" Double Hip
 Raised Panel
 Ovolo Sticking
 1/0 x 6/8
 1/2 x 6/8



F37982LEW
 Low-E
 7/8" SDL Bar
 1-7/16" Double Hip
 Raised Panel
 Wide Layout
 Ovolo Sticking
 2/8 x 6/8 2/8 x 7/0
 3/0 x 6/8 3/0 x 7/0



F37508LEW
 Low-E
 7/8" SDL Bar
 1-7/16" Double Hip
 Raised Panel
 Wide Layout
 Ovolo Sticking
 2/6 x 6/8 2/6 x 7/0
 2/8 x 6/8 2/8 x 7/0
 3/0 x 6/8 3/0 x 7/0

Douglas Fir

SASH DOORS 7/8" SDL BAR & 1-7/16" DOUBLE HIP RAISED PANEL



Performance 7/8" SDL Bar, 1-7/16" Double Hip Raised Panel with Low-E Glass



Performance Door Corner

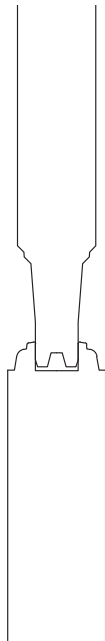

Panel Profile

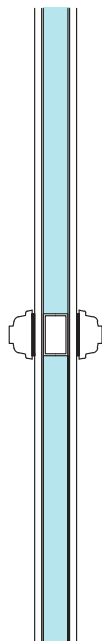

Glass Profile



F37662LE, Simpson

PERFORMANCE BETTER DURABILITY



F37120
IG
7/8" SDL Bar
1-7/16" Double Hip
Raised Panel
Ovolo Sticking
2/8 x 6/8
3/0 x 6/8



F37662LE
Low-E
7/8" SDL Bar
1-7/16" Double Hip
Raised Panel
Wide Layout
Ovolo Sticking
3/0 x 8/0



F37504LE
Low-E
7/8" SDL Bar
1-7/16" Double Hip
Raised Panel
Wide Layout
Ovolo Sticking
3/0 x 8/0



F37506LE
Low-E
7/8" SDL Bar
1-7/16" Double Hip
Raised Panel
Wide Layout
Ovolo Sticking
2/8 x 8/0
3/0 x 8/0



F37512LE
Low-E
7/8" SDL Bar
1-7/16" Double Hip
Raised Panel
Wide Layout
Ovolo Sticking
3/0 x 8/0



SASH DOORS
7/8" SDL BAR & 1-7/16" DOUBLE HIP RAISED PANEL

Douglas Fir

SASH DOORS 7/8" SDL BAR & 1-7/16" DOUBLE HIP RAISED PANEL



Performance 7/8" SDL Bar, 1-7/16" Double Hip Raised Panel & IG Glass

PERFORMANCE BETTER DURABILITY



Performance Door Corner

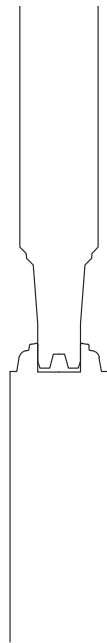

Panel Profile

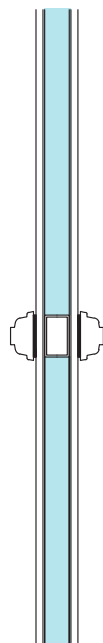

Glass Profile



F37944

IG
7/8" SDL Bar
1-7/16" Double Hip
Raised Panel
Ovolo Sticking

2/6 x 6/8 2/6 x 7/0
2/8 x 6/8 2/8 x 7/0
3/0 x 6/8 3/0 x 7/0

F37703

IG
7/8" SDL Bar
1-7/16" Double Hip
Raised Panel
Ovolo Sticking

1/0 x 6/8 1/0 x 7/0
1/2 x 6/8 1/2 x 7/0



F37508

IG
 7/8" SDL Bar
 1-7/16" Double Hip
 Raised Panel
 Wide Layout
 Ovolo Sticking

2/0 x 6/8 2/0 x 7/0
 2/6 x 6/8 2/6 x 7/0
 2/8 x 6/8 2/8 x 7/0
 3/0 x 6/8 3/0 x 7/0



F37804

IG
 7/8" SDL Bar
 1-7/16" Double Hip
 Raised Panel
 Wide Layout
 Ovolo Sticking

1/0 x 6/8 1/0 x 7/0
 1/2 x 6/8 1/2 x 7/0



F37662LE

Low-E
 7/8" SDL Bar
 1-7/16" Double Hip
 Raised Panel
 Wide Layout
 Ovolo Sticking

3/0 x 6/8
 3/0 x 7/0



F37663LE

Low-E
 7/8" SDL Bar
 1-7/16" Double Hip
 Raised Panel
 Wide Layout
 Ovolo Sticking

1/0 x 6/8 1/0 x 7/0
 1/2 x 6/8 1/2 x 7/0



F37134

IG
 7/8" SDL Bar
 1-7/16" Double Hip
 Raised Panel
 Wide Layout*
 Ovolo Sticking

2/8 x 6/8* 3/0 x 7/0*
 3/0 x 6/8*



F37512

IG
 7/8" SDL Bar
 1-7/16" Double Hip
 Raised Panel
 Wide Layout
 Ovolo Sticking

2/8 x 6/8 2/8 x 7/0
 3/0 x 6/8 3/0 x 7/0

Douglas Fir

SASH DOORS 7/8" SDL BAR & 1-7/16" BEADED V-GROOVE DOUBLE HIP RAISED PANEL



Performance 1-7/16" Beaded V-Groove Double Hip Raised Panel with Low-E Glass

PERFORMANCE BETTER DURABILITY



Performance Door Corner

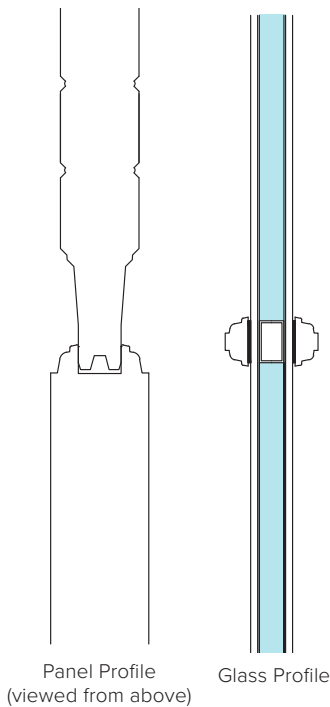

F37228

Low-E
7/8" SDL Bar
1-7/16" Beaded V-Groove
Double Hip Raised Panel
Wide Layout
Ovolo Sticking
3/0 x 6/8 3/0 x 7/0

F37219

Low-E
7/8" SDL Bar
1-7/16" Beaded V-Groove
Double Hip Raised Panel
Wide Layout
Ovolo Sticking
1/0 x 7/0 1/0 x 7/0
1/2 x 6/8 1/2 x 7/0



F37226
 Low-E
 7/8" SDL Bar
 1-7/16" Beaded
 V-Groove
 Double Hip
 Raised Panel
 Wide Layout
 Ovolo Sticking
 3/0 x 6/8



F37217
 Low-E
 7/8" SDL Bar
 1-7/16" Beaded
 V-Groove
 Double Hip
 Raised Panel
 Ovolo Sticking
 1/0 x 6/8 1/0 x 8/0
 1/2 x 6/8 1/2 x 8/0



F37224
 Low-E
 7/8" SDL Bar
 1-7/16" Beaded
 V-Groove
 Double Hip
 Raised Panel
 Wide Layout
 Ovolo Sticking
 2/8 x 6/8
 3/0 x 6/8
 2/8 x 7/0
 3/0 x 7/0



F37215
 Low-E
 7/8" SDL Bar
 1-7/16" Beaded
 V-Groove
 Double Hip
 Raised Panel
 Ovolo Sticking
 1/0 x 6/8
 1/2 x 6/8
 1/0 x 7/0
 1/2 x 7/0



F37222
 Low-E
 7/8" SDL Bar
 1-7/16" Beaded
 V-Groove
 Double Hip
 Raised Panel
 Wide Layout
 Ovolo Sticking
 3/0 x 6/8



F37213
 Low-E
 7/8" SDL Bar
 1-7/16" Beaded
 V-Groove
 Double Hip
 Raised Panel
 Ovolo Sticking
 1/0 x 6/8
 1/2 x 6/8



F37218
 Low-E
 7/8" SDL Bar
 1-7/16" Beaded V-Groove
 Double Hip
 Raised Panel
 Wide Layout
 Ovolo Sticking
 3/0 x 6/8



F37216
 Low-E
 7/8" SDL Bar
 1-7/16" Beaded V-Groove
 Double Hip
 Raised Panel
 Wide Layout
 Ovolo Sticking
 3/0 x 6/8



F37214
 Low-E
 7/8" SDL Bar
 1-7/16" Beaded V-Groove
 Double Hip
 Raised Panel
 Wide Layout
 Ovolo Sticking
 3/0 x 6/8



F37212
 Low-E
 7/8" SDL Bar
 1-7/16" Beaded V-Groove
 Double Hip
 Raised Panel
 Wide Layout
 Ovolo Sticking
 3/0 x 6/8

Douglas Fir

SASH DOORS 1-3/8" TDL BAR & 1-7/16" DOUBLE HIP RAISED PANEL

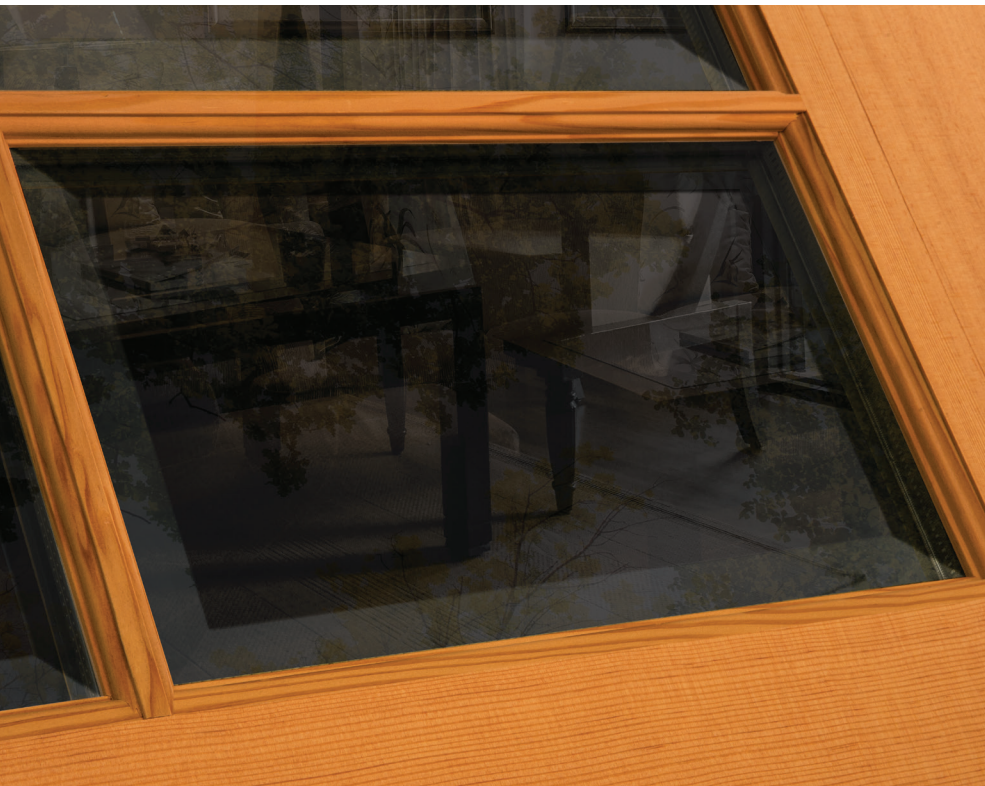

Performance 1-3/8" TDL Bar, 1-7/16" Double Hip Raised Panel & IG Beveled Glass

PERFORMANCE BETTER DURABILITY



F7598
 IG Beveled
 1-3/8" TDL Bar
 1-7/16" Double Hip
 Raised Panel
 Wide Layout
 Ovolo Sticking

3/0 x 6/8
 3/0 x 7/0

F7599
 IG Beveled
 1-3/8" TDL Bar
 1-7/16" Double Hip
 Raised Panel
 Ovolo Sticking

1/0 x 6/8 1/0 x 7/0
 1/2 x 6/8 1/2 x 7/0



Performance Door Corner

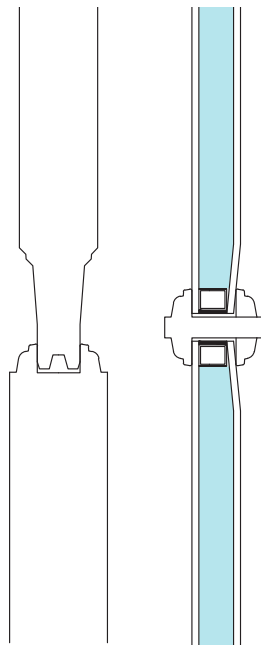

Panel Profile

Glass Profile
 Beveled

SASH DOORS 2-3/4" TDL BAR & 1-7/16" DOUBLE HIP RAISED PANEL



Performance 2-3/4" TDL Bar, 1-7/16" Double Hip Raised Panel

PERFORMANCE BETTER DURABILITY



F7860

IG
2-3/4" TDL Bar
1-7/16" Double Hip
Raised Panel
Wide Layout
Ovolo Sticking

3/0 x 6/8
3/0 x 7/0

F7260

IG
2-3/4" TDL Bar
1-7/16" Double Hip
Raised Panel
Ovolo Sticking

1/0 x 6/8 1/0 x 7/0
1/2 x 6/8 1/2 x 7/0



Performance Door Corner

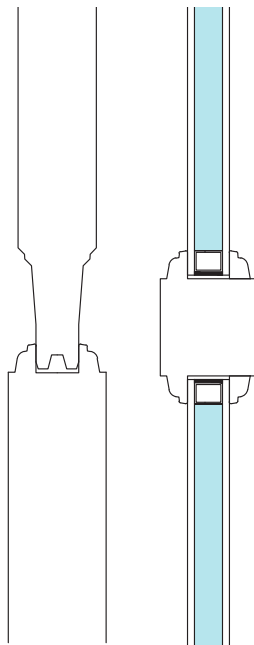

Panel Profile

Glass Profile



F7860LE

Low-E
2-3/4" TDL Bar
1-7/16" Double Hip
Raised Panel
Ovolo Sticking

3/0 x 8/0

F7260LE

Low-E
2-3/4" TDL Bar
1-7/16" Double Hip
Raised Panel
Ovolo Sticking

1/0 x 8/0
1/2 x 8/0

Douglas Fir

SASH DOORS 1-1/4" TDL BAR & 3/4" DOUBLE HIP RAISED PANEL



Standard 1-1/4" TDL Bar, 3/4" Double Hip Raised Panel with Single Pane Safety Glass



Standard Door Corner

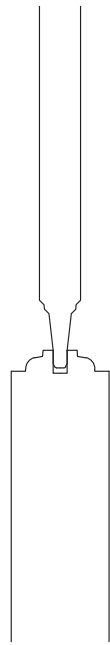

Panel Profile

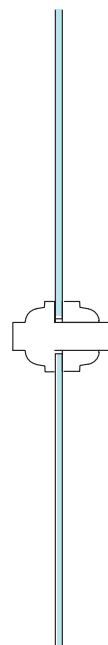

Glass Profile



F2134
 Single Pane
 Safety Glass
 1-1/4" TDL Bar
 3/4" Double Hip
 Raised Panel
 Ovolo Sticking
 2/8 x 6/8
 3/0 x 6/8



F2005
 Single Pane
 Safety Glass
 1-3/4" TDL Bar
 3/4" Double Hip
 Raised Panel
 Ovolo Sticking
 3/0 x 6/8



F1662
 Single Pane
 Safety Glass
 1-1/4" TDL Bar
 3/4" Double Hip
 Raised Panel
 Ovolo Sticking
 2/8 x 6/8
 3/0 x 6/8



F318
 Single Pane
 Safety Glass
 1-1/4" TDL Bar
 3/4" Double Hip
 Raised Panel
 Ovolo Sticking
 2/6 x 6/8
 2/8 x 6/8
 3/0 x 6/8



F418
 Single Pane
 Safety Glass
 1-1/4" TDL Bar
 3/4" Double Hip
 Raised Panel
 Ovolo Sticking
 2/6 x 6/8
 2/8 x 6/8
 3/0 x 6/8



F944
 Single Pane
 Safety Glass
 1-1/4" TDL Bar
 3/4" Double Hip
 Raised Panel
 Ovolo Sticking
 2/6 x 6/8
 2/8 x 6/8
 3/0 x 6/8



F2035
 Single Pane
 Safety Glass
 1-1/4" TDL Bar
 3/4" Double Hip
 Raised Panel
 Ovolo Sticking
 2/8 x 6/8
 3/0 x 6/8

Douglas Fir

SASH DOORS 2-3/4" TDL BAR & 3/4" FLAT PANEL



Nantucket® 2-3/4" TDL Bar, 3/4" Flat Panel with Low-E Glass



Nantucket® Door Corner

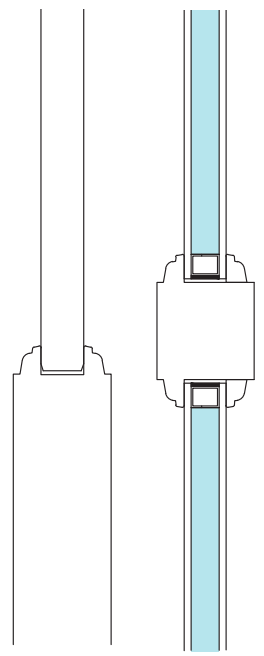

Panel Profile

Glass Profile

NANTUCKET® BEST DURABILITY



F77860

Low-E
2-3/4" TDL Bar
3/4" Flat Panel
Ovolo Sticking
Wide Layout

3/0 x 6/8



F77260

Low-E
2-3/4" TDL Bar
3/4" Flat Panel
Ovolo Sticking

1/2 x 6/8

SASH DOORS 1-3/8" TDL BAR & 3/4" FLAT PANEL



Performance 1-3/8" TDL Bar, 3/4" Flat Panel with IG Glass



Performance Door Corner

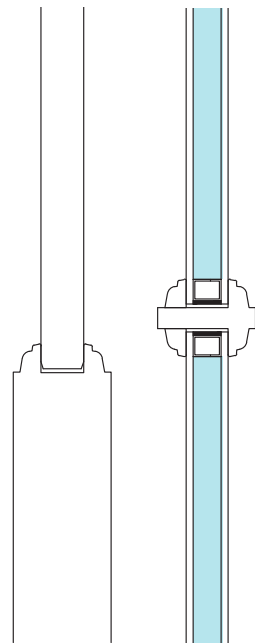

Panel Profile Glass Profile

PERFORMANCE BETTER DURABILITY



F6803
IG
1-3/8" TDL Bar
3/4" Flat Panel
Wide Layout
Ovolo Sticking

3/0 x 6/8



F6803LE
Low-E
1-3/8" TDL Bar
3/4" Flat Panel
Wide Layout
Ovolo Sticking

3/0 x 6/8

Douglas Fir

SASH DOORS 7/8" SDL BAR & 3/4" FLAT PANEL



Nantucket® 7/8" SDL Bar, 3/4" Flat Panel with Low-E Glass



Nantucket® Door Corner

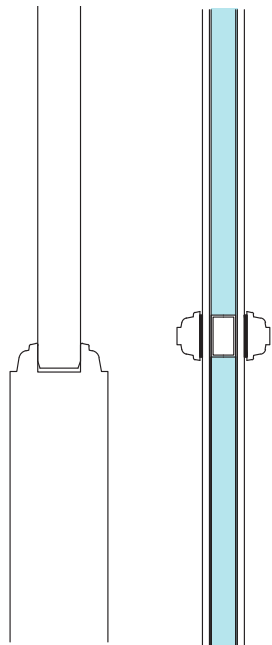

Panel Profile

Glass Profile



NANTUCKET® BEST DURABILITY



F77660

Low-E
7/8" SDL Bar
3/4" Flat Panel
Ovolo Sticking
Wide Layout

3/0 x 6/8

F77663

Low-E
7/8" SDL Bar
3/4" Flat Panel
Ovolo Sticking
1/2 x 6/8



SDL Close-up



Douglas Fir

CONTEMPORARY DOORS SATIN ETCH GLASS



Contemporary with Satin Etch Low-E Glass



Glass Close-up

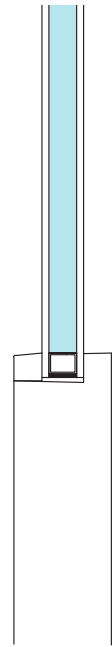

Glass Profile

Contemporary doors feature shaker sticking on the interior, with a gently sloped waterfall profile on the exterior, which allows water to cascade off and away from the door.

PERFORMANCE BETTER DURABILITY



F7403LEE
Low-E
Satin Etch Glass
Wide Layout
Shaker Sticking
2/8 x 6/8
3/0 x 6/8



F7404LEE
Low-E
Satin Etch Glass
Wide Layout
Shaker Sticking
2/8 x 6/8
3/0 x 6/8
3/0 x 8/0



F7405LEE
Low-E
Satin Etch Glass
Wide Layout
Shaker Sticking
2/8 x 6/8
3/0 x 6/8



F7406LEE
Low-E
Satin Etch Glass
Wide Layout
Shaker Sticking
3/0 x 8/0



F7701LEE
Low-E
Satin Etch Glass
Wide Layout
Shaker Sticking
1/2 x 6/8
1/2 x 8/0



F7404LEE, Simpson

Douglas Fir

FRENCH DOORS



Nantucket® with Low-E Glass

NANTUCKET® BEST DURABILITY

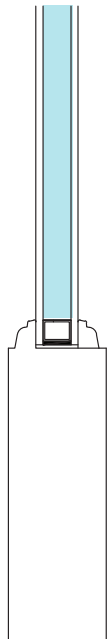

Glass Profile



F77002
Low-E
Ovolo Sticking
Wide Layout
3/0 x 6/8



F77701
Low-E
Ovolo Sticking
1/2 x 6/8



WaterBarrier® with Low-E Glass - Exterior Side



Interior Side

WATERBARRIER® BEST DURABILITY

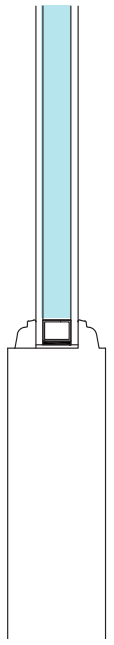

Glass Profile



F7002LEW
Low-E
Ovolo Sticking
Wide Layout

2/6 x 6/8	2/0 x 8/0
2/8 x 6/8	2/6 x 8/0
3/0 x 6/8	2/8 x 8/0
	3/0 x 8/0



F7701LEW
Low-E
Ovolo Sticking

1/0 x 6/8	1/0 x 7/0
1/2 x 6/8	1/2 x 7/0



F7037W
IG
Ovolo Sticking
Wide Layout

2/6 x 6/8	2/6 x 7/0
2/8 x 6/8	2/8 x 7/0
3/0 x 6/8	3/0 x 7/0

Douglas Fir

FRENCH DOORS



Performance with Low-E Glass

PERFORMANCE BETTER DURABILITY

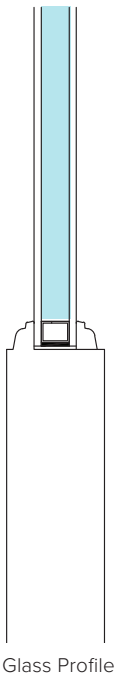

F7001

IG
Ovolo Sticking

2/0 x 6/8	2/0 x 7/0	2/0 x 8/0
2/4 x 6/8	2/4 x 7/0	2/6 x 8/0
2/6 x 6/8	2/6 x 7/0	2/8 x 8/0
2/8 x 6/8	2/8 x 7/0	3/0 x 8/0
3/0 x 6/8	3/0 x 7/0	



F7701

IG
Ovolo Sticking

1/0 x 6/8	1/0 x 7/0
1/2 x 6/8	1/2 x 7/0



F7037LE

Low-E
Wide Layout
Ovolo Sticking

3/0 x 8/0

PERFORMANCE BETTER DURABILITY

STANDARD GOOD DURABILITY

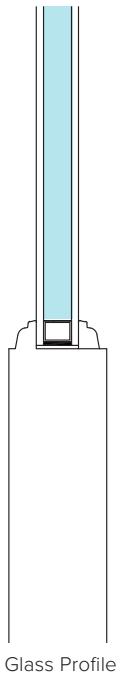

F7002LE

Low-E
Ovolo Sticking
Wide Layout

2/0 x 6/8	2/0 x 8/0
2/6 x 6/8	2/6 x 8/0
2/8 x 6/8	2/8 x 8/0
3/0 x 6/8	3/0 x 8/0

F7701LE

Low-E
Ovolo Sticking

1/0 x 6/8	1/0 x 8/0
1/2 x 6/8	1/2 x 8/0
1/0 x 7/0	
1/2 x 7/0	

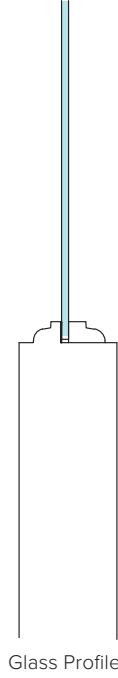

F1501

1/8" Single Pane
Safety Glass
Ovolo Sticking

2/0 x 8/0	2/6 x 8/0	3/0 x 8/0
2/4 x 8/0	2/8 x 8/0	

PERFORMANCE BETTER DURABILITY



F6422

Black Caming IG
Wide Layout
Ovolo Sticking

3/0 x 6/8
3/0 x 7/0

F6423

Black Caming IG
Ovolo Sticking

1/0 x 6/8	1/0 x 7/0
1/2 x 6/8	1/2 x 7/0



Terrace Ridge® Glass with Black Caming Close-up

Douglas Fir

FRENCH DOORS 7/8" SDL BAR



Nantucket® 7/8" SDL Bar with Low-E Glass

NANTUCKET® BEST DURABILITY

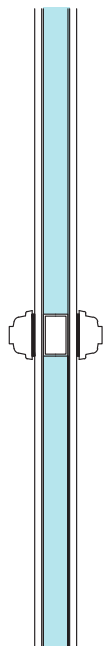

Glass Profile



F77015
Low-E
7/8" SDL Bar
Ovolo Sticking
Wide Layout
3/0 x 6/8



F77705
Low-E
7/8" SDL Bar
Ovolo Sticking
1/2 x 6/8

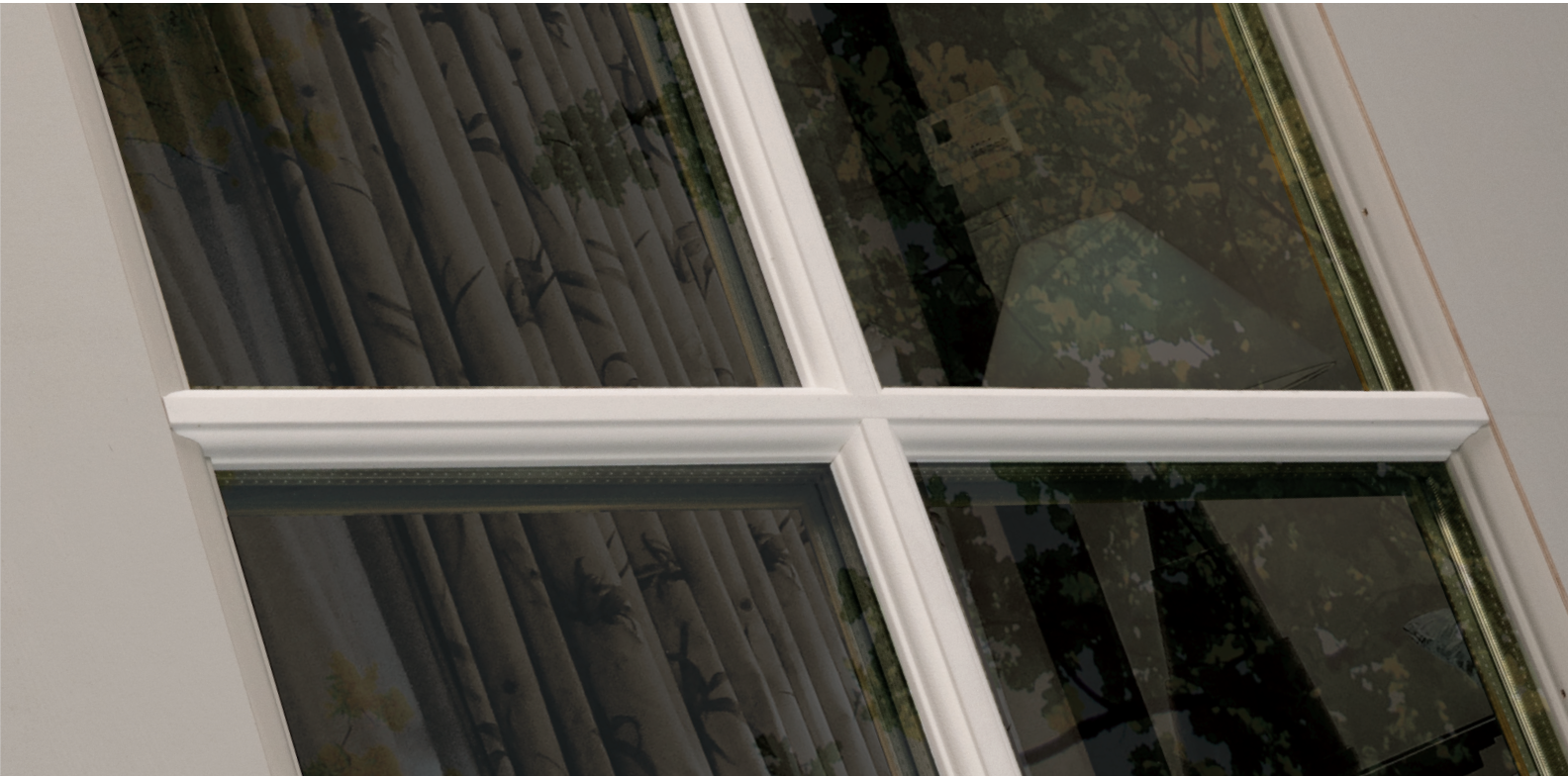

WaterBarrier® 7/8" SDL Bar with Low-E Glass - Exterior Side

WATERBARRIER® BEST DURABILITY



F37010LEW

Low-E
7/8" SDL Bar
Wide Layout
Ovolo Sticking

2/0 x 6/8
2/0 x 7/0



F37705LEW

Low-E
7/8" SDL Bar
Ovolo Sticking

1/0 x 6/8 1/0 x 7/0
1/2 x 6/8 1/2 x 7/0



F37015LEW

Low-E
7/8" SDL Bar
Wide Layout
Ovolo Sticking

2/6 x 6/8 2/6 x 7/0
2/8 x 6/8 2/8 x 7/0
3/0 x 6/8 3/0 x 7/0



SDL Close-up - Interior Side

Douglas Fir

FRENCH DOORS 7/8" SDL BAR



Performance 7/8" SDL Bar with IG Glass

PERFORMANCE BETTER DURABILITY

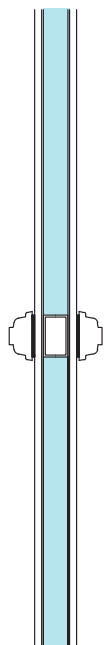

Glass Profile



F37010
IG
7/8" SDL Bar
Ovolo Sticking

2/0 x 6/8
2/0 x 7/0



F37705
IG
7/8" SDL Bar
Ovolo Sticking

1/0 x 6/8 1/0 x 7/0
1/2 x 6/8 1/2 x 7/0



F37015
IG
7/8" SDL Bar
Wide Layout*
Ovolo Sticking

2/6 x 6/8 2/6 x 7/0
2/8 x 6/8* 2/8 x 7/0*
3/0 x 6/8* 3/0 x 7/0*



F37109, Simpson

PERFORMANCE BETTER DURABILITY



F37109

IG
7/8" SDL Bar
Ovolo Sticking

2/8 x 6/8 2/8 x 7/0
3/0 x 6/8 3/0 x 7/0



F37709

IG
7/8" SDL Bar
Ovolo Sticking

1/0 x 6/8 1/0 x 7/0
1/2 x 6/8 1/2 x 7/0



SDL Close-up



Douglas Fir

FRENCH DOORS 1-1/4" TDL BAR



Standard 1-1/4" TDL Bar with Single Pane Safety Glass



TDL Close-up

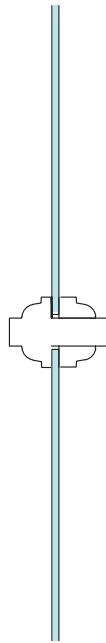

Glass Profile



F1510, Simpson

STANDARD GOOD DURABILITY



F1510
 Single Pane
 Safety Glass
 Film Protected
 1-1/4" TDL Bar
 Ovolo Sticking
 2/0 x 6/8
 2/0 x 7/0



F1512
 Single Pane
 Safety Glass
 1-1/4" TDL Bar
 Ovolo Sticking
 2/0 x 8/0



F1515
 Single Pane
 Safety Glass
 Film Protected
 1-1/4" TDL Bar
 Ovolo Sticking
 2/4 x 6/8 2/4 x 7/0
 2/6 x 6/8 2/6 x 7/0
 2/8 x 6/8 2/8 x 7/0
 2/10 x 6/8 2/10 x 7/0
 3/0 x 6/8 3/0 x 7/0

Douglas Fir

DUTCH DOORS

Reeb's stock of dutch doors are for inswing applications only. An excellent multi-point locking option for Dutch Doors is Tru-Lock®. It offers 2 points of contact and operates in place of a deadbolt. This multi-point lock option has the unique ability to pull the two sections of the door closer to the weatherstripping creating a tighter seal. For more information on Tru-Lock® see page 123.



1-7/16" Double Hip Raised Panel



For more information on custom door options, see page 130.



Performance Door Corner

Dutch Doors feature a solid bottom rail and the Weather Seal™ process, but do not come standard with UltraBlock®.

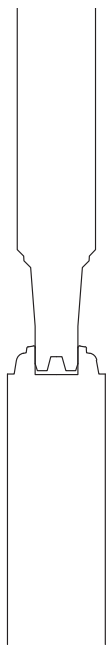

Panel Profile



SDL Close-up

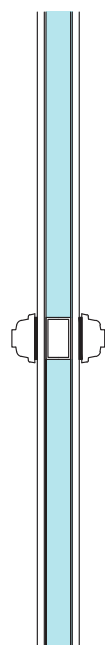

Glass Profile



FD4011

IG
1-7/16" Double Hip
Raised Panel
Solid Bottom Rail
Ovolo Sticking
2/8 x 6/8
3/0 x 6/8

FD4013

IG
1-7/16" Double Hip
Raised Panel
Solid Bottom Rail
Ovolo Sticking
2/8 x 6/8
3/0 x 6/8

FD2011

IG
7/8" SDL Bar
1-7/16" Double Hip
Raised Panel
Solid Bottom Rail
Ovolo Sticking
2/8 x 6/8
3/0 x 6/8

FD2013

IG
7/8" SDL Bar
1-7/16" Double Hip
Raised Panel
Solid Bottom Rail
Ovolo Sticking
2/8 x 6/8
3/0 x 6/8

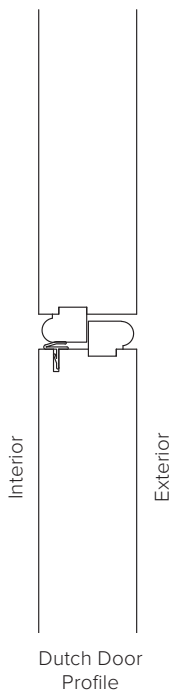

Dutch Door Quadrant

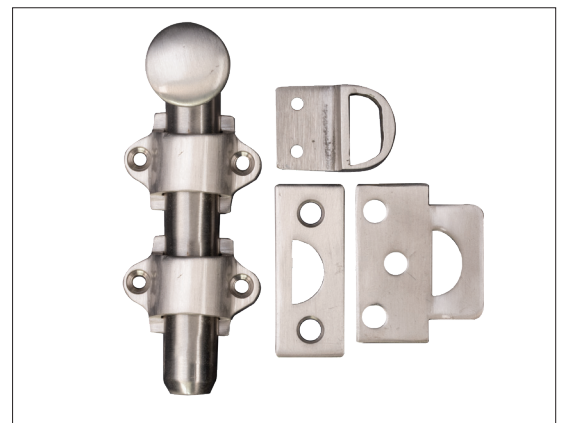

Dutch Door Bolt

Recommended where the top half will be opened frequently.

Both the Door Quadrant and the Door Bolt are available in the following finishes:



US3
Bright Brass



US15
Satin Nickel

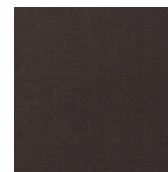

US10B
Oil Rubbed
Bronze

Douglas Fir

TRANSOMS & DENTIL SHELVES

Transoms are an excellent addition to a door unit as a way to allow more natural light into the home. All rectangular transom units have a Unit Dimension height of 13-1/2". Transoms with 5-1/2" stiles will match doors that have a wide layout.

Single Door Unit



F37743

Used with a single door
Clear Glass
7/8" SDL Bar
4-1/2" Stiles



F37753

Used with a single door
Clear Glass
7/8" SDL Bar
5-1/2" Stiles

Single Door with Sidelite Unit



F7711LE

Used with a 1/0 x 3/0 x 1/0 Continuous Unit
Low-E Glass
2-3/16" Stiles



F37715

Used with a 1/0 x 3/0 x 1/0 Continuous Unit
Clear Glass
7/8" SDL Bar
2-3/16" Stiles



F37725

Used with a 1/2 x 3/0 x 1/2 Continuous Unit
Clear Glass
7/8" SDL Bar
2-3/16" Stiles

Double Door Unit



F3774560

Used with a 6/0 Double Door Unit
Clear Glass
7/8" SDL Bar
4-1/2" Stiles

Double Door Unit or Single Door with Sidelites Unit



F7751

72" Width
Used with a 1/2 x 3/0 x 1/2 or 6/0 Double Door Unit
Clear Glass
5-1/2" Stiles



F7751LE

72" Width
Used with a 1/2 x 3/0 x 1/2 or 6/0 Double Door Unit
Low-E Glass
5-1/2" Stiles



F37755

72" Width
Used with a 1/2 x 3/0 x 1/2 or 6/0 Double Door Unit
Clear Glass
7/8" SDL Bar
5-1/2" Stiles

Dentil Shelves

Dentil shelves are a nice complement to a Craftsman style door. Choose from a 4 block or a 16 block option.



F9541

4 Block Dentil Shelf



F9540

20 Block Dentil Shelf



F6803 (door), **F9541** (optional dentil shelf)
Custom sidelite and transom, Simpson

Sapele Mahogany

PANEL DOORS 1-7/16" DOUBLE HIP RAISED PANEL



Nantucket® 1-7/16" Double Hip Raised Panel



Metropolitan™ 1-7/16" Double Hip Raised Panel



Nantucket® Door Corner

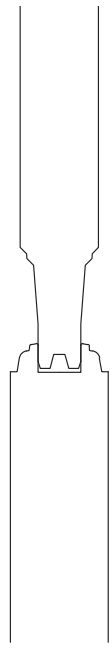

Panel Profile



Metropolitan™ Door Corner

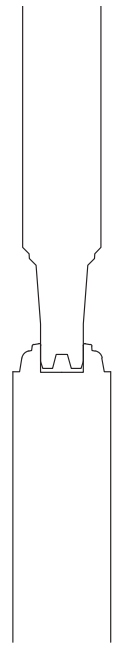

Panel Profile

NANTUCKET® BEST DURABILITY



SM77465
1-7/16" Double Hip
Raised Panel
Ovolo Sticking
Wide Layout

3/0 x 6/8



SM77144
1-7/16" Double Hip
Raised Panel
Ovolo Sticking
Wide Layout

3/0 x 6/8



SM77130
1-7/16" Double Hip
Raised Panel
Ovolo Sticking
Wide Layout

3/0 x 6/8
3/6 x 6/8



SM77701
Low-E
Ovolo Sticking

1/2 x 6/8

METROPOLITAN™ BEST DURABILITY



MSM7282*
1-7/16" Double Hip
Raised Panel
Ovolo Sticking
Wide Layout

2/8 x 6/8 2/8 x 8/0
3/0 x 6/8 3/0 x 8/0



MSM7701
Low-E
Ovolo Sticking

1/0 x 6/8 1/0 x 8/0
1/2 x 6/8 1/2 x 8/0



MSM7465
1-7/16" Double Hip
Raised Panel
Ovolo Sticking
Wide Layout

2/8 x 6/8 2/8 x 8/0
3/0 x 6/8 3/0 x 8/0



MSM7282M*
1-7/16" Double Hip
Raised Panel
Wide Layout
Ovolo Sticking
Modified Layout

2/8 x 6/8 2/8 x 8/0
3/0 x 6/8 3/0 x 8/0



MSM7230M*
1-7/16" Double Hip
Raised Panel
Ovolo Sticking
Modified Layout
Wide Layout

2/8 x 6/8
3/0 x 6/8



*These doors are able to include Raised Moulding on the Exterior side (RE) or on the Interior side (RI) of the door.

Sapele Mahogany

PANEL DOORS 1-7/16" DOUBLE HIP RAISED PANEL



Performance 1-7/16" Double Hip Raised Panel



Performance Door Corner



Raised Moulding on 1 Side - Exterior Side

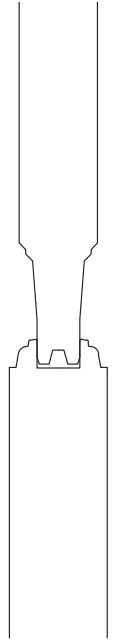

Panel Profile



SM7282
1-7/16" Double Hip
Raised Panel
Ovolo Sticking
Wide Layout

3/0 x 6/8
3/0 x 7/0



SM7702
IG
1-7/16" Double Hip
Raised Panel
Ovolo Sticking

1/0 x 6/8 1/0 x 7/0
1/2 x 6/8 1/2 x 7/0



SM7344
1-7/16" Double Hip
Raised Panel
Ovolo Sticking
Wide Layout

3/0 x 6/8
3/0 x 7/0



SM7130
1-7/16" Double Hip
Raised Panel
Ovolo Sticking
Wide Layout

3/0 x 6/8 3/0 x 7/0

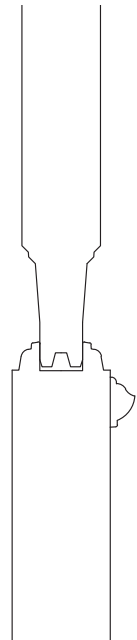

Panel Profile



SM7282RM
1-7/16" Double Hip
Raised Panel
Wide Layout
Raised Moulding, 1 Side
Ovolo Sticking

3/0 x 6/8
3/0 x 7/0



SM7702RM
IG
1-7/16" Double Hip
Raised Panel
Raised Moulding, 1 Side
Ovolo Sticking

1/2 x 6/8
1/2 x 7/0

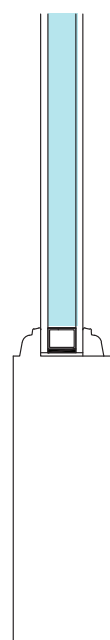

Glass Profile



SM7501LE
Low-E
1-7/16" Double Hip
Raised Panel
Wide Layout
Ovolo Sticking

2/6 x 6/8 2/6 x 8/0
2/8 x 6/8 2/8 x 8/0
3/0 x 6/8 3/0 x 8/0



SM7801LE
Low-E
1-7/16" Double Hip
Raised Panel
Ovolo Sticking

1/0 x 6/8 1/0 x 8/0
1/2 x 6/8 1/2 x 8/0

Sapele Mahogany

SASH DOORS 7/8" SDL BAR & 1-7/16" DOUBLE HIP RAISED PANEL



Nantucket 7/8" SDL Bar & 1-7/16" Double Hip Raised Panel with Low-E Glass



Nantucket Door Corner

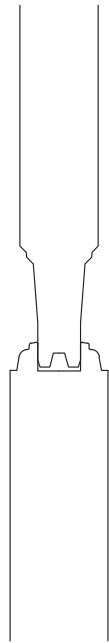

Panel Profile

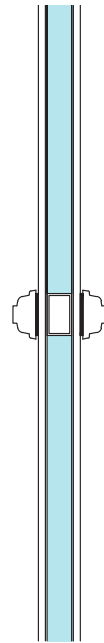

Glass Profile



SM77506
 Low-E
 7/8" SDL Bar
 1-7/16" Double Hip
 Raised Panel
 Ovolo Sticking
 Wide Layout
 3/0 x 6/8



SM77803
 Low-E
 7/8" SDL Bar
 1-7/16" Double Hip
 Raised Panel
 Ovolo Sticking
 1/2 x 6/8



SM77944
 Low-E
 7/8" SDL Bar
 1-7/16" Double Hip
 Raised Panel
 Ovolo Sticking
 Wide Layout
 3/0 x 6/8



SM77703
 Low-E
 7/8" SDL Bar
 1-7/16" Double Hip
 Raised Panel
 Ovolo Sticking
 1/2 x 6/8



SM77662
 Low-E
 7/8" SDL Bar
 1-7/16" Double Hip
 Raised Panel
 Ovolo Sticking
 Wide Layout
 3/0 x 6/8



SM77663
 Low-E
 7/8" SDL Bar
 1-7/16" Double Hip
 Raised Panel
 Ovolo Sticking
 1/2 x 6/8



SM77662, Simpson

Sapele Mahogany

SASH DOORS 7/8" SDL BAR & 1-7/16" DOUBLE HIP RAISED PANEL



Performance 7/8" SDL Bar, 1-7/16" Double Hip Raised Panel with IG Glass



Performance Door Corner

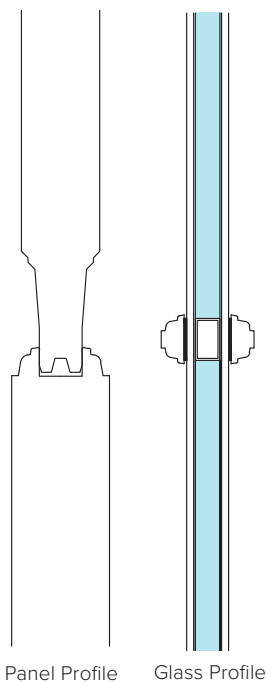

Panel Profile

Glass Profile

PERFORMANCE BETTER DURABILITY



SM37944

IG
7/8" SDL Bar
1-7/16" Double Hip
Raised Panel
Wide Layout
Ovolo Sticking
3/0 x 6/8 3/0 x 7/0

SM37703

IG
7/8" SDL Bar
1-7/16" Double Hip
Raised Panel
Ovolo Sticking
1/0 x 6/8 1/0 x 7/0
1/2 x 6/8 1/2 x 7/0

FRENCH DOORS



SM7002, Simpson

PERFORMANCE BETTER DURABILITY

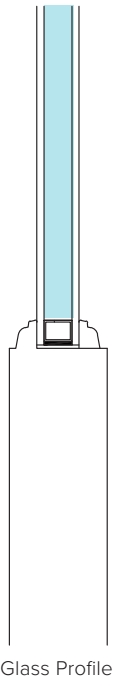

Glass Profile



SM7002
IG
Ovolo Sticking
Wide Layout

3/0 x 6/8
3/0 x 7/0



SM37705
IG
7/8" SDL Bar
Ovolo Sticking

1/0 x 6/8 1/0 x 7/0
1/2 x 6/8 1/2 x 7/0

Sapele Mahogany

FRENCH DOORS 7/8" SDL BAR



Nantucket® 7/8" SDL Bar

NANTUCKET® BEST DURABILITY

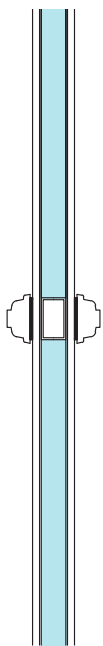

Glass Profile



SM77015

Low-E
7/8" SDL Bar
Ovolo Sticking
Wide Layout

3/0 x 6/8



SM77705

Low-E
7/8" SDL Bar
Ovolo Sticking

1/2 x 6/8



SM77015, Simpson



EASY
STAINABILITY

FRENCH DOORS
7/8" SDL BAR

Ponderosa Pine

PANEL DOORS 1-7/16" DOUBLE HIP RAISED PANEL



Performance 1-7/16" Double Hip Raised Panel

PERFORMANCE BETTER DURABILITY



Performance Door Corner

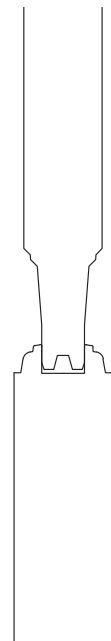

Panel Profile



P7282
1-7/16" Double Hip
Raised Panel
Ovolo Sticking
Wide Layout

2/6 x 6/8 2/6 x 7/0
2/8 x 6/8 2/8 x 7/0
3/0 x 6/8 3/0 x 7/0



P7130
1-7/16" Double Hip
Raised Panel
Ovolo Sticking
Wide Layout

2/8 x 6/8 2/8 x 7/0
2/10 x 6/8 2/10 x 7/0
3/0 x 6/8 3/0 x 7/0

SASH DOORS 1-7/16" DOUBLE HIP RAISED PANEL



Performance 1-7/16" Double Hip Raised Panel with IG Glass

PERFORMANCE BETTER DURABILITY

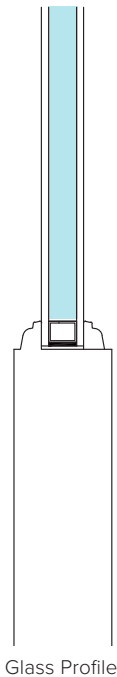

P7132
IG
1-7/16" Double Hip
Raised Panel
Ovolo Sticking
Wide Layout
3/0 x 6/8



P7044
IG
1-7/16" Double Hip
Raised Panel
Wide Layout
Ovolo Sticking
2/8 x 6/8
3/0 x 6/8
3/0 x 7/0



P7702
IG
1-7/16" Double Hip
Raised Panel
Ovolo Sticking
1/0 x 6/8 1/0 x 7/0
1/2 x 6/8 1/2 x 7/0



P7501
IG
1-7/16" Double Hip
Raised Panel
Ovolo Sticking
Wide Layout
3/0 x 6/8
3/0 x 7/0

Ponderosa Pine

PANEL DOORS 3/4" SINGLE HIP RAISED PANEL



Standard 3/4" Single Hip Raised Panel

STANDARD GOOD DURABILITY



Standard Door Corner

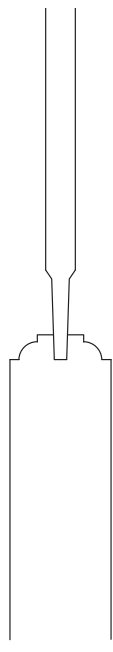

Panel Profile



P1053
3/4" Single Hip
Raised Panel
Reverse Layout
Ovolo Sticking

2/6 x 6/8
2/8 x 6/8
3/0 x 6/8



P100
3/4" Single Hip
Raised Panel
Reverse Layout
Ovolo Sticking

1/6 x 6/8 2/8 x 6/8 2/6 x 7/0
2/0 x 6/8 2/10 x 6/8 2/8 x 7/0
2/4 x 6/8 3/0 x 6/8 2/10 x 7/0
2/6 x 6/8 3/6 x 6/8 3/0 x 7/0

SASH DOORS 1-5/16" TDL BAR & 1-3/16" DOUBLE HIP RAISED PANEL



Standard 1-5/16" TDL Bar



Standard 1-3/16" Double Hip Raised Panel

STANDARD GOOD DURABILITY



Standard Door Corner

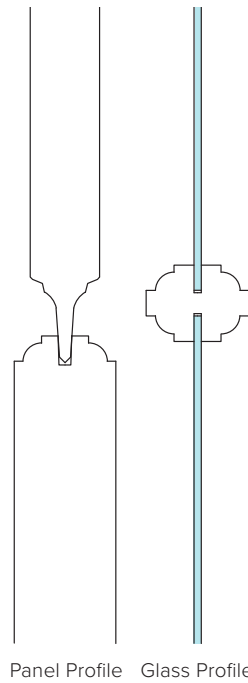

Panel Profile Glass Profile



P182
Single Pane
1-3/16" Double Hip
Raised Panel
Ovolo Sticking
2/6 x 6/8
2/8 x 6/8
3/0 x 6/8



P944
Single Pane
1-5/16" TDL Bar
1-3/16" Double Hip
Raised Panel
Ovolo Sticking
2/6 x 6/8
2/8 x 6/8
3/0 x 6/8

Ponderosa Pine

SASH DOORS 1-5/16" TDL BAR & 1-3/16" DOUBLE HIP RAISED PANEL



Standard 1-5/16" TDL Bar & 1-3/16" Double Hip Raised Panel with Single Pane Glass



Standard Door Corner

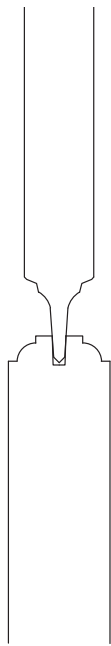

Panel Profile



TDL Close-up

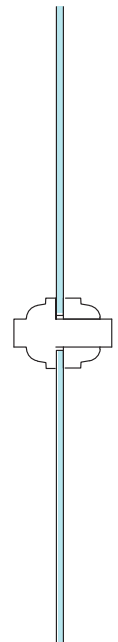

Glass Profile



P26146

Single Pane
1-5/16" TDL Bar
1-3/16" Double Hip
Raised Panel
Ovolo Sticking

3/0 x 6/8



P982

Single Pane
1-5/16" TDL Bar
1-3/16" Double Hip
Raised Panel
Ovolo Sticking

3/0 x 6/8



P2035

Single Pane
1-5/16" TDL Bar
1-3/16" Double Hip
Raised Panel
Ovolo Sticking

2/6 x 6/8
2/8 x 6/8
3/0 x 6/8



P510

Single Pane
1-5/16" TDL Bar
1-3/16" Double Hip
Raised Panel
Ovolo Sticking

2/0 x 6/8



P512

Single Pane
1-5/16" TDL Bar
1-3/16" Double Hip
Raised Panel
Ovolo Sticking

2/6 x 6/8
2/8 x 6/8
3/0 x 6/8



P1705

Single Pane
1-5/16" TDL Bar
Ovolo Sticking

1/0 x 6/8 1/0 x 7/0
1/2 x 6/8 1/2 x 7/0
1/4 x 6/8 1/4 x 7/0
1/6 x 6/8 1/6 x 7/0

Ponderosa Pine

FRENCH DOORS



Performance with Low-E Glass

PERFORMANCE BETTER DURABILITY

STANDARD GOOD DURABILITY

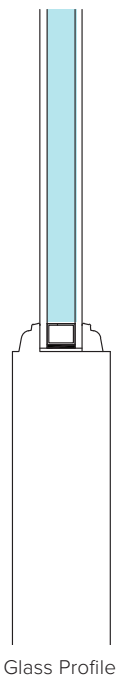

P7002LE

Low-E
Wide Layout
Ovolo Sticking
2/0 x 6/8 2/8 x 6/8
2/4 x 6/8 2/10 x 6/8
2/6 x 6/8 3/0 x 6/8



P7701LE

Low-E
Ovolo Sticking
1/0 x 6/8
1/2 x 6/8
1/6 x 6/8

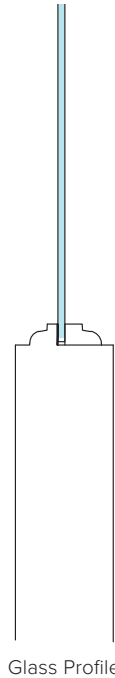

P1501

Safety Glass
Ovolo Sticking
2/6 x 6/8
2/8 x 6/8
3/0 x 6/8



P1701

Single Pane
Ovolo Sticking
1/0 x 6/8 1/0 x 7/0
1/2 x 6/8 1/2 x 7/0

FRENCH DOORS 1-5/16" TDL BAR



Standard 1-5/16" TDL Bar

STANDARD GOOD DURABILITY

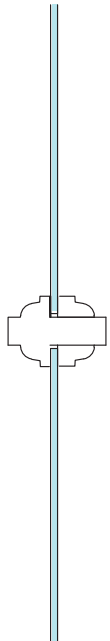

Glass Profile



P1510

Safety Glass
1-5/16" TDL Bar
Ovolo Sticking

1/8 x 6/8	1/8 x 7/0
1/10 x 6/8	1/10 x 7/0
2/0 x 6/8	2/0 x 7/0
2/2 x 6/8	2/2 x 7/0



P1512

Safety Glass
1-5/16" TDL Bar
Ovolo Sticking

2/0 x 8/0



P1515

Safety Glass
1-5/16" TDL Bar
Ovolo Sticking

2/4 x 6/8	2/4 x 7/0
2/6 x 6/8	2/6 x 7/0
2/8 x 6/8	2/8 x 7/0
2/10 x 6/8	2/10 x 7/0
3/0 x 6/8	3/0 x 7/0



P1518

Safety Glass
1-5/16" TDL Bar
Ovolo Sticking

2/6 x 8/0
2/8 x 8/0
3/0 x 8/0

Red Oak

PANEL DOORS 1-7/16" DOUBLE HIP RAISED PANEL



Performance 1-7/16" Double Hip Raised Panel



Performance Door Corner

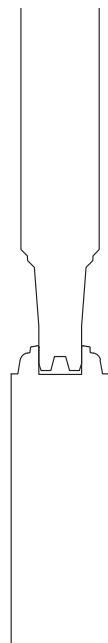

Panel Profile

PERFORMANCE BETTER DURABILITY

WHILE SUPPLIES LAST



O7344

1-7/16" Double Hip
Raised Panel
Ovolo Sticking
Wide Layout

3/0 x 6/8



O7130

1-7/16" Double Hip
Raised Panel
Ovolo Sticking
Wide Layout

2/8 x 6/8
3/0 x 6/8

SASH DOORS 7/8" SDL BAR & 1-7/16" DOUBLE HIP RAISED PANEL



PERFORMANCE BETTER DURABILITY

WHILE SUPPLIES LAST

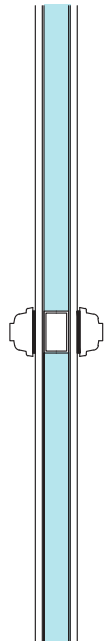

Glass Profile



O37944

IG
7/8" SDL Bar
1-7/16" Double Hip
Raised Panel
Ovolo Sticking
Wide Layout
3/0 x 6/8



O37703

IG
7/8" SDL Bar
1-7/16" Double Hip
Raised Panel
Ovolo Sticking
1/0 x 6/8 1/2 x 6/8

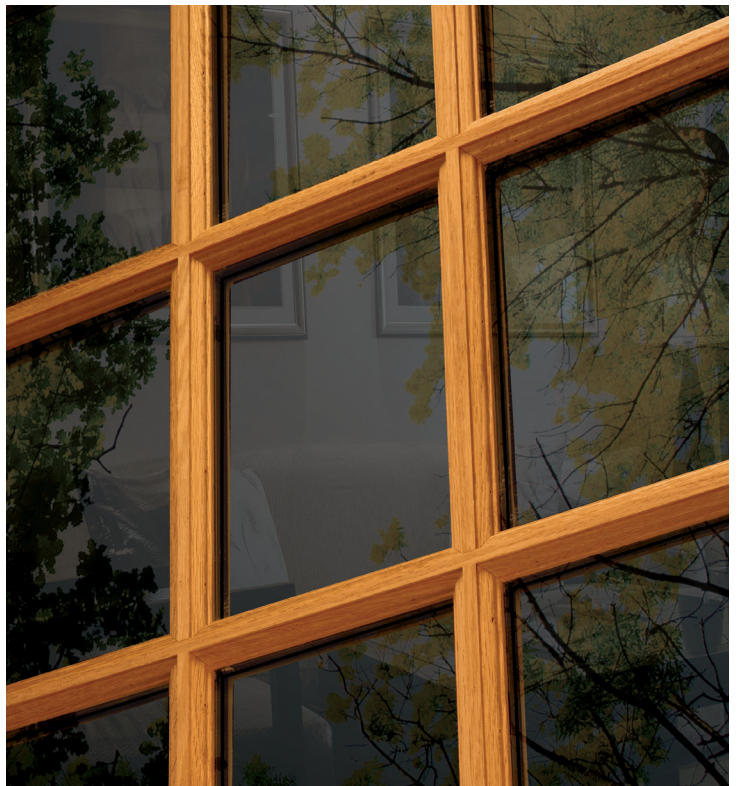

7/8" SDL Close-up

Anatomy of an Exterior Door Unit



Transoms



DIRECT SET TRANSOM



SASH SET TRANSOM

Additional Accessories



KICK PLATE



DOOR VIEWER



MAILSLOT

Door Unit Configurations and Handing

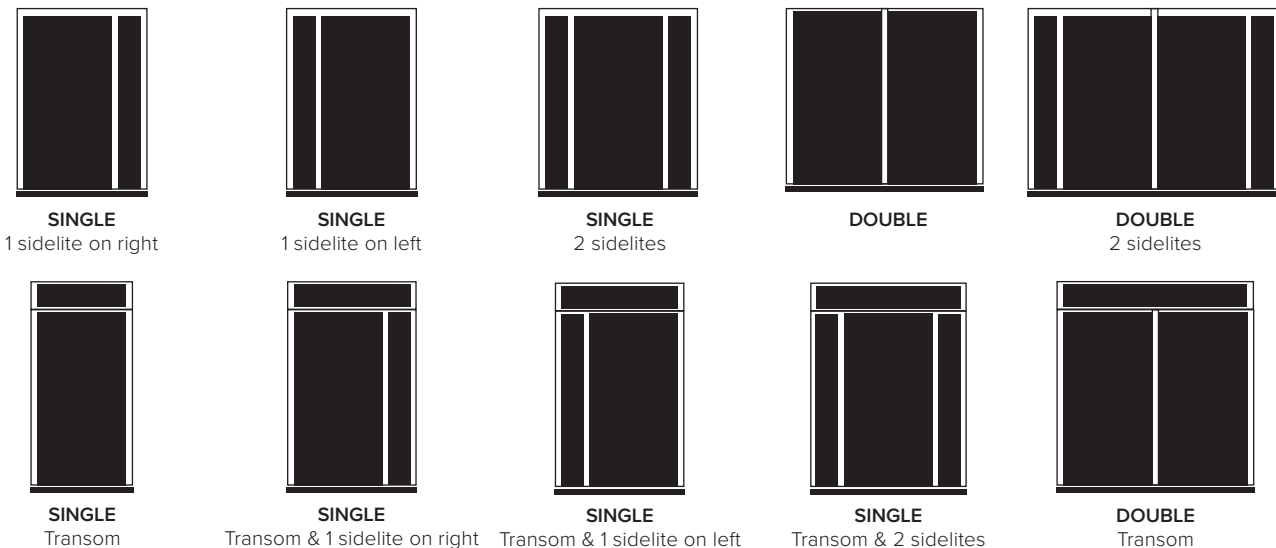

Door Handing

Handing is viewed from the exterior side of the door.

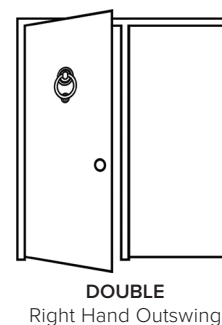
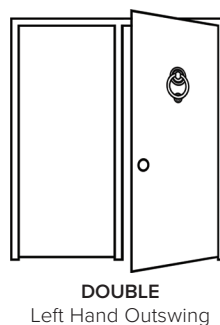
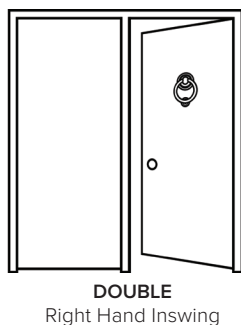
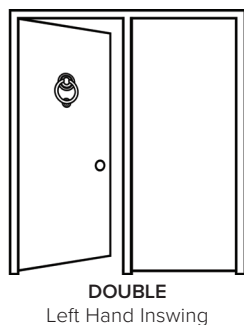
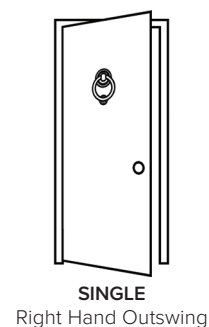
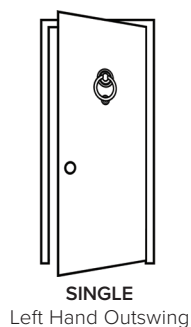
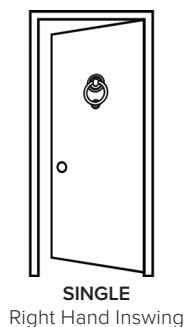
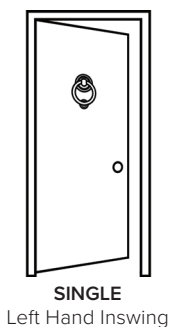
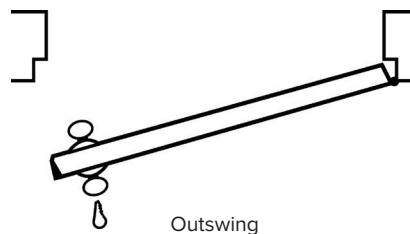
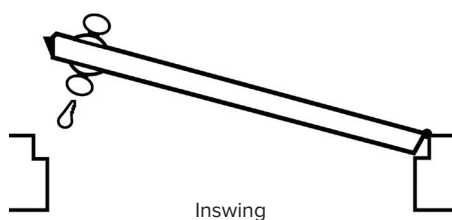

Frames

Exterior Frames come in a variety of options to best match your door unit. The kerf, or cutout, in the frame will have weatherstrip applied to help keep the elements out of the home. Choose from solid wood, FrameSaver® which has a composite block at the bottom, fully composite On-Guard™ jamb, or the PVC Ultra.



Primed

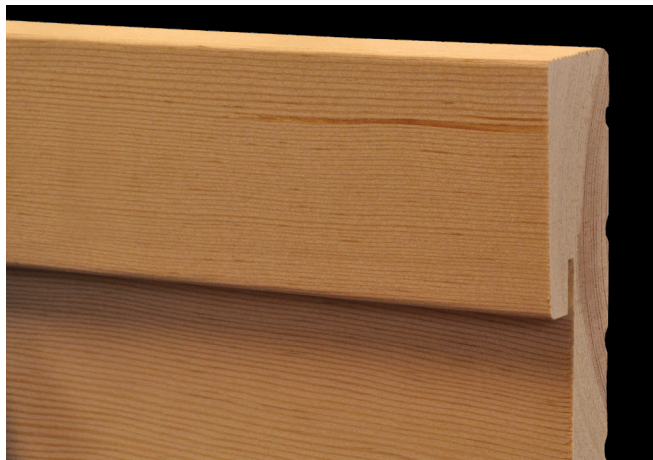

Solid Fir



Solid Clear Pine



Solid Oak



Solid Sapele Mahogany



On-Guard™ Grained



On-Guard™ Primed

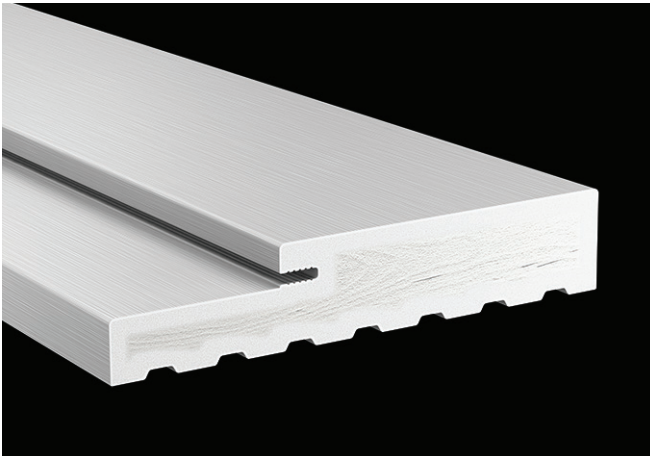

On-Guard™ White Shield



Primed FrameSaver®

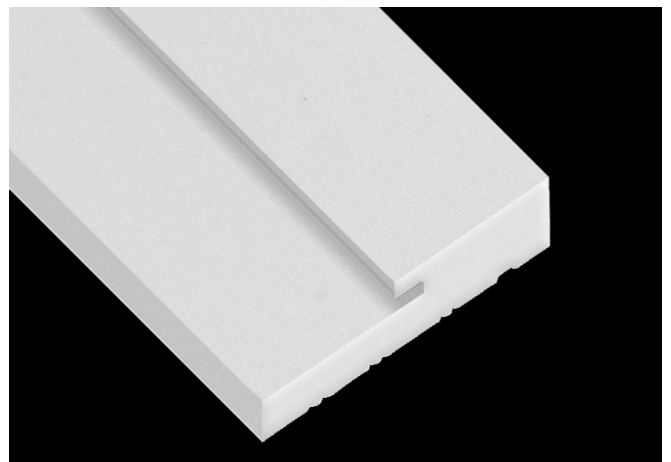

Ultra

For more information on Frames
visit learn.reeb.com/stainable-exterior-frames/ or learn.reeb.com/primed-exterior-frames/

Brickmould & Casing



Primed

2" Brickmould
1x4 Flat Casing
1x6 Flat Casing

5/4x4 Flat Casing
5/4x6 Flat Casing



Solid Fir

2" Brickmould
5/4x4 Flat Casing
5/4x6 Flat Casing



Solid Clear Pine

2" Brickmould
5/4x4 Flat Casing
5/4x6 Flat Casing



Solid Oak

2" Brickmould
5/4x4 Flat Casing
5/4x6 Flat Casing



Solid Mahogany

2" Brickmould
5/4x4 Flat Casing
5/4x6 Flat Casing



Solid Sapele Mahogany

2" Brickmould
5/4x4 Flat Casing
5/4x6 Flat Casing



On-Guard™ Grained
2" Brickmould



On-Guard™ Primed
2" Brickmould



On-Guard™ White Shield
2" Brickmould

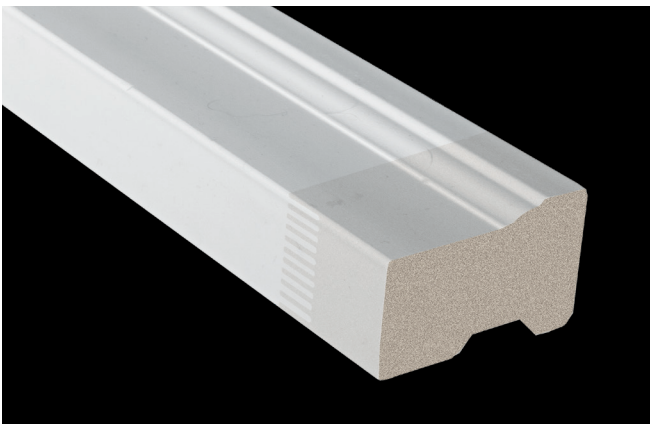

FrameSaver®
2" Brickmould
3" Brickmould
5/4x4 Flat Casing



Ultra
2" Brickmould
1x4 Flat Casing
1x6 Flat Casing
5/4x4 Flat Casing
5/4x6 Flat Casing

Sills



INSWING 7/4 OAK SILL



INSWING 7/4 MAHOGANY SILL



INSWING 7/4 SILL LINE ART



INSWING NEW ENGLAND PROFILE OAK SILL



INSWING NEW ENGLAND PROFILE MAHOGANY SILL

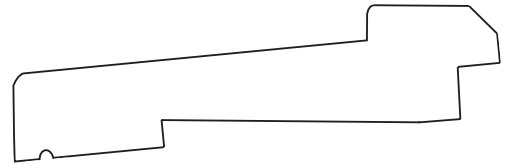

INSWING NEW ENGLAND PROFILE SILL LINE ART



OUTSWING 7/4 OAK SILL



OUTSWING 7/4 SILL LINE ART

SILL HORNS

Sill horns are a portion of the sill that extends in front of the jamb legs. The brickmould or casing rests on top of the horn, or extension, for a more traditional look.





INSWING ADJUSTABLE COMPOSITE SILL

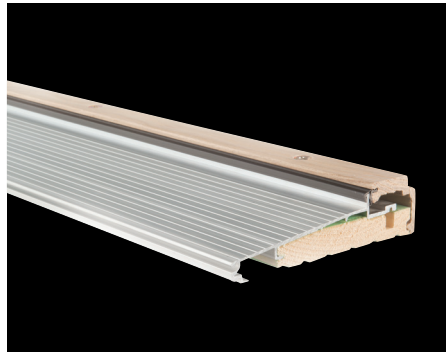

INSWING ADJUSTABLE HARDWOOD SILL

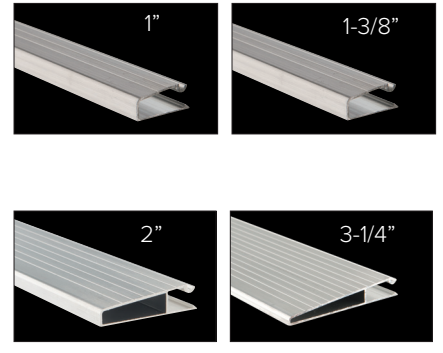

INSWING SILL EXTENDERS

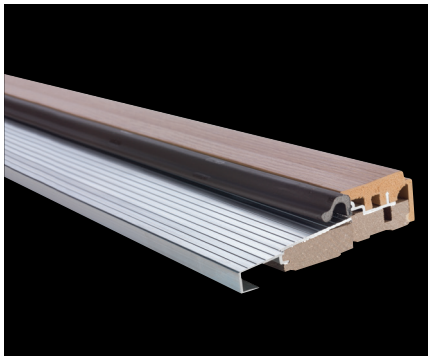

OUTSWING COMPOSITE SILLS



OUTSWING SILL EXTENDERS

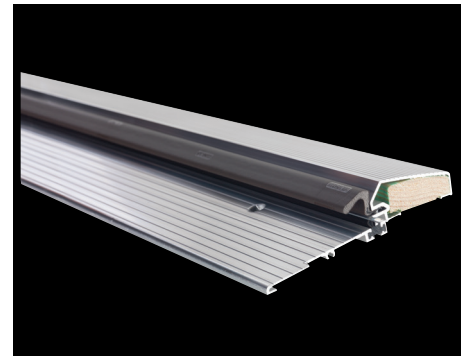

OUTSWING BUMPER SILL



INSWING ENDURA® PUBLIC ACCESS SILL

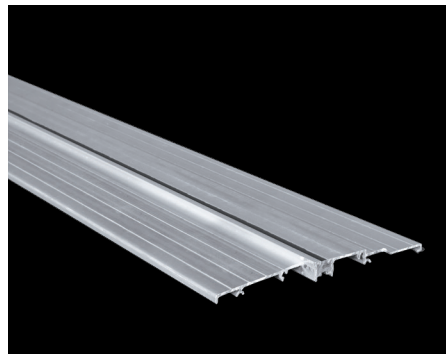

OUTSWING ENDURA® PUBLIC ACCESS SILL



INSWING ENDURA® TILE BACK PUBLIC ACCESS SILL

SILL FINISH OPTIONS



Mill Finish

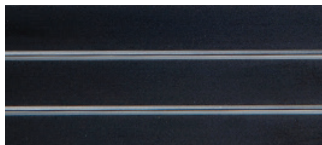

Bronze Finish



Satin Nickel Finish (N/A PA sill)

CAP COLOR OPTIONS



Light Cap

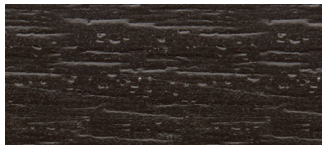

Dark Cap



Hardwood Cap (Inswing Only)

For more information on Sills

visit learn.reeb.com/sill-options-for-exterior-doors/

Ultimate Astragal

ULTIMATE FLIP LEVER ASTRAGAL

The Ultimate Flip Lever Astragal combines enhanced performance with the benefits of enhanced accessibility and ease of use. Just one flip of the easy-to-use built-in lever activates the Floating Boot and Flush Bolt system, securing the unit with two lasting seals, even in imperfect or changing conditions. The Floating Boot and Flush Bolt deliver a perfect seal every time, operating independently of each other to seal against the lowest point on the sill when engaged, while lifting clear of the sill when retracted for lasting, damage-free operation.

HOW THE ULTIMATE FLIP LEVER ASTRAGAL WORKS:



With the Flip Lever upright, the Floating Boot and Flush Bolt are lifted clear of the sill.



As the Flip Lever is lowered, the Floating Boot drops independently to seal against the cap.



After the Floating Boot, the Flush Bolt lowers, engaging with the sill regardless of drill hole depth.

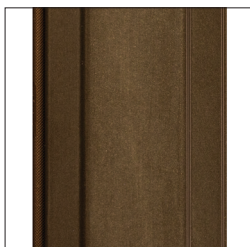

Bronze



Fir Wrap



Oak Wrap



Mahogany Wrap

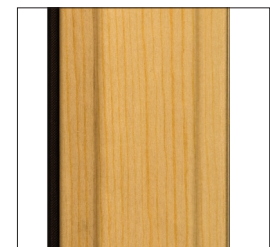

Pine Wrap

ULTIMATE MULTI-POINT ASTRAGAL

Protect your home and eliminate traditional double-door performance challenges with the one of a kind Multi-Point Astragal. MPA delivers the sealing power of a multi-point lock without the multi-point price tag – multi-point functionality is built right into the astragal and even works with standard deadbolt packages for ultimate cost-efficiency. Plus, MPA automatically forms a custom seal against the sill cap, even if conditions aren't perfect, saving time and eliminating costly service calls. Beyond delivering improved performance, MPA is easy to use, providing Enhanced Accessibility for a product homeowners will love.



Bronze

ULTIMATE TRILENNIUM ASTRAGAL

Built to complement the strength and security of the Trilennium Multi-Point Locking System, the Endura® Trilennium Compatible Astragal offers superior French door performance. The standard Flip lever secures your French door unit with two lasting seals without reaching or bending, protecting against air and water infiltration, eliminating callbacks and putting your mind at ease. Expect high-performance and strength to work together with the Trilennium Compatible Astragal. Smarter French door performance and protection offer ultimate peace of mind when paired with the strongest lock on the market.



Bronze



Fir Wrap



Oak Wrap



Mahogany Wrap

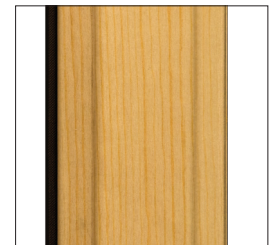

Pine Wrap

Hinges Overview

Hinges are hardware that attach the door to the frame. They position the door to properly compress the weatherstrip and help ensure smooth operation. Hinges are available in multiple finishes, shapes, manufacturers and functions that complement a variety of door styles.

Hinge Size

The standard hinge size for a wood door is 4" x 4".

For a heavier duty hinge, a square 4-1/2" x 4-1/2" hinge is available for a 1-3/4" door.



4" X 4"



4-1/2" X 4-1/2"

Hinge Shape

The standard hinge has a corner with a 5/8" radius.

For a more architectural look, square corner hinges are available.



RADIUS



SQUARE

Hinge Types

Different hinge types exist based on the application of the door.



BALL-BEARING HINGE

Hinges include steel ball bearings in between the knuckle for added support and stability.



NON-BALL BEARING HINGE

Non-ball bearing hinges have no buffer between each knuckle, wearing down the hinge over time.



NRP HINGE

NRP Hinges include a non-removable pin (NRP) for use with an outswing door unit.



SELF-CLOSING HINGE

Self-closing hinges contain a tension spring that automatically closes a door each time it is opened.

Baldwin®

HINGES

Baldwin believes that quality should never be a compromise. From using the finest materials to crafting hardware by hand, they are committed to creating high-quality hardware that not only looks beautiful and flawless but also endures the rigors of time.



4" X 4" 5/8" RADIUS
Non-Ball Bearing
(shown in US3LF)

Available in: US3LF



4" X 4" SQUARE
Non-Ball Bearing
(shown in US10B)

Available in: US3LF, US10B,
US15, VB



4-1/2" X 4-1/2" SQUARE
Non-Ball Bearing
(shown in US10B)

Available in: US3LF, US10B,
US15, VB



4-1/2" X 4-1/2" SQUARE
Ball Bearing
(shown in US3LF)

Available in: US3LF, US10B,
US15, VB

Available Finishes

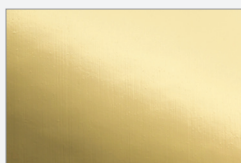

US3LF
Lifetime Brass

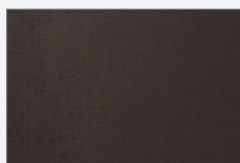

US10B
Oil Rubbed Bronze

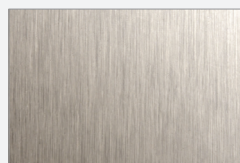

US15
Satin Nickel

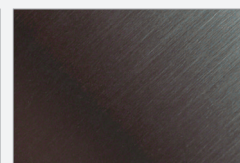

VB
Venetian Bronze

Emtek is dedicated to bring personal style to life. Door hardware is more than a way to open, close, and secure a space. It is an integral part of a room's design theme and an extension of personal style.



4" X 4" SQUARE
Non-Ball Bearing
(shown in US10B)

Available in: US1D, US3, US7, US10B, US14, US15, US26, US26D

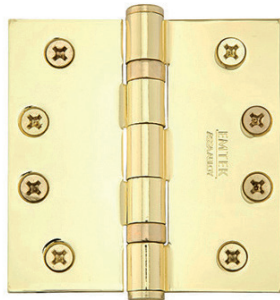

4" X 4" SQUARE
Ball Bearing
(shown in US3)

Available in: US1D, US3, US7, US10B, US14, US15, US26, US26D



4" X 4" SQUARE
NRP Ball Bearing
(shown in US15)

Available in: US3, US10B, US15, US26, US26D

Available Finishes

Not all finishes are available in both Emtek and RSP.

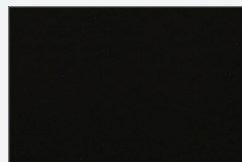

US1D
Flat Black

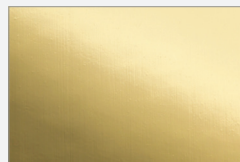

US3
Bright Brass

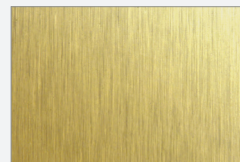

US4
Satin Brass



US4B
Light Brass

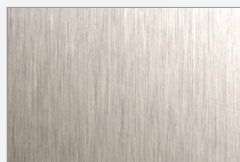

US15
Satin Nickel

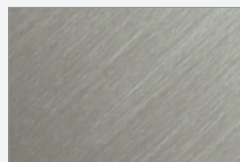

US15A
Antique Nickel

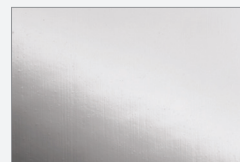

US26
Polished Chrome

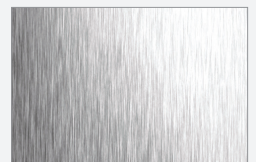

US26D
Satin Chrome

Reeb® Specialty Products

HINGES

RSP offers a large selection of hinges in a variety of finishes carrying on a tradition of innovative design, superior quality and service excellence.



4" X 4" 5/8" RADIUS
Non-Ball Bearing
(shown in US15)

Available in: US1D, US3, US4, US4B, US5, US10B, US15, US15A, US26, US26D, US32D, USP



4" X 4" 5/8" RADIUS
NRP Non-Ball Bearing
(shown in US10B)

Available in: US1D, US3, US4B, US5, US10B, US15, US26, US26D, US32D



4" X 4" 5/8" RADIUS
Ball Bearing
(shown in US15)

Available in: US1D, US3, US4B, US5, US10B, US15, US26, US26D



4" X 4" 5/8" RADIUS
NRP Ball Bearing
(shown in US15)

Available in: US1D, US3, US4B, US5, US10B, US15, US15A, US26, US26D, US32D



4" X 4" 5/8" RADIUS
Self-Closing
(shown in US15)

Available in: US1D, US3, US4B, US10B, US15, US26, US26D



4" X 4" SQUARE
Non-Ball Bearing
(shown in US10B)

Available in: US1D, US3, US4, US5, US10B, US15, US26, US26D



4" X 4" SQUARE
Ball Bearing
(shown in US10B)

Available in: US3, US4, US4B, US5, US10B, US15, US26, US26D

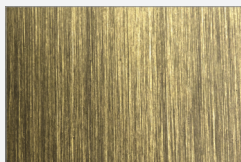

US5
Antique Brass

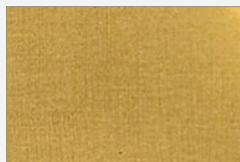

US7
French Antique

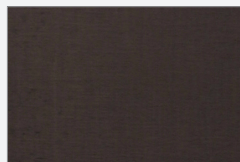

US10B
Oil Rubbed Bronze

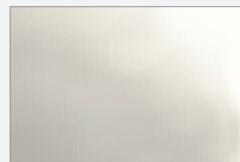

US14
Polished Nickel

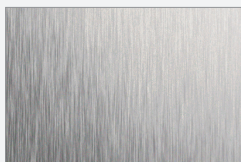

US32D
Stainless Steel

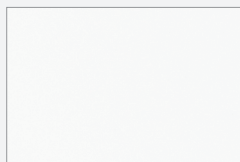

USP
Primed

Endura Trilennium®

HARDWARE

The Trilennium Multi-Point Lock features a beefy, one piece, I-beam that strengthens the edge of the door as an additional measure to help prevent warping over the life of the door. It spans 55-1/2" to increase the strength and precision of the lock.

The Trilennium Multi-Point Lock features 3 latches that drop into the keeper without any action needed from the operator. When the key or thumb turn are turned, the latches extend deeper into the frame for security.

Reeb stocks this multi-point lock for 6/8, 7/0, and 8/0 hieght, 1-3/4" thick wood doors. In addition to the hardware, Reeb also stocks a lever x lever Eclipse trim and a grip handleset with an Eclipse lever on the inside in the finishes listed below.

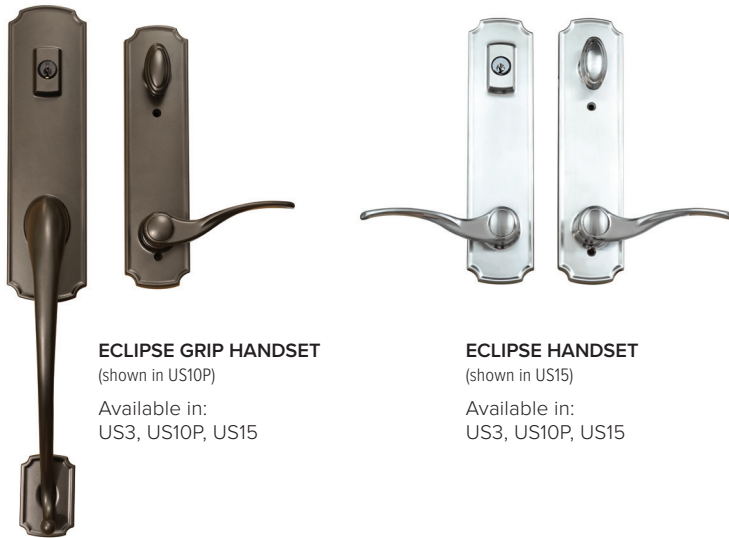

ECLIPSE GRIP HANDSET
(shown in US10P)

Available in:
US3, US10P, US15

ECLIPSE HANDSET
(shown in US15)

Available in:
US3, US10P, US15



Available Finishes

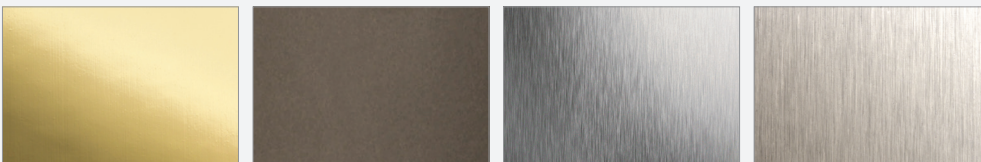

US3
Bright Brass

US10P
Victorian Bronze

US32D*
Stainless Steel

US15**
Satin Nickel

*Trilennium MPL only
**Handset only

Tru-Lock®

HARDWARE

Tru-Lock® is a locking option that offers 2 points of contact approximately 18" apart. It requires the least amount of prep and works in a standard double bore. Tru-Lock operates just like a standard dead-bolt system making it very intuitive to operate. The key and thumb turn operates the flip bolts that lock into slotted strikes in the jamb.

Tru-Lock® is adaptable to work with most off the shelf trim hardware, because it works off the deadbolt mechanism of your door. Reeb offers Tru-Lock for 1-3/4" doors that are 6/8, 7/0, or 8/0 in height.



Available Finishes

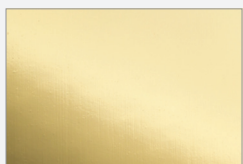

US3LF

Bright Brass/Lifetime Brass

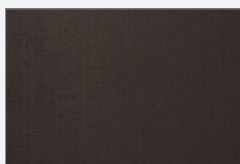

US10B

Oil Rubbed Bronze

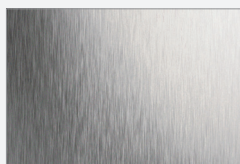

US32D

Stainless Steel

For more information on Tru-Lock

visit learn.reeb.com/multi-point-lock-options/

Schlage®

HARDWARE

Locks are an integral part in providing security to a home and holding the door tight against the weather strip for a good seal from the elements. Locks come in a variety of styles, options, and finishes. Cylindrical locks are the most common lock type available. These locks are installed into a bore that is cut in the face of the door while a latch bolt is installed into a bore on the edge of the door. This type of lock has a quick and easy installation process. Reeb offers multiple types of handlesets for different design and finish options.



J SERIES
JH58/JH59 (shown in US3)

The JH58 and JH59 work together to make a functional locking system. The JH58 is the exterior portion which includes the locking mechanism, while the JH59 is the interior portion.

PAGE 125



F SERIES
F58/F59 (shown in US15)

The F58 and F59 work together to make a functional locking system. The F58 is the exterior portion which includes the locking mechanism, while the F59 is the interior portion which includes latches and installation hardware.

PAGE 126



F SERIES
F92/F94 (shown in US3LF)

The F92 and F94 work together to make a dummy trim system. The F92 is the exterior portion, while the F94 is the interior portion.

PAGE 127



B SERIES/ F SERIES
BE365/FE285 (shown in US5)

The BE365 and FE285 work together to make a functional locking system. The BE365 is an electronic battery operated deadbolt which includes the locking mechanism, while the FE285 is the handleset portion.

PAGE 128



F SERIES
FE595 (shown in US15)

The FE595 is a stand-alone electronic battery operated locking system with a built in handleset.

PAGE 129

Lockset Handing

Many lockset levers are handed. Handing is a term used to indicate how a door swings and it is necessary to choose the right lever for your door. When standing on the outside of the door, look at where the hinges are.

- If the hinges are on the left, you have a left handed door. You will need a left handed (LH) lock.
- If the hinges are on the right, you have a right handed door. You will need a right handed (RH) lock.

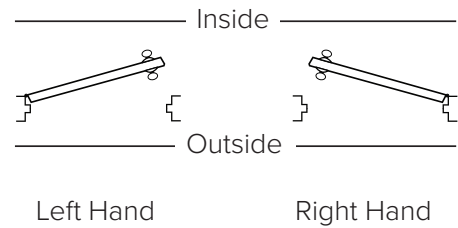

JH58

The JH58 is an exterior facing handle set. It has locking capabilities, however, it does not include an interior lever or knob set. Therefore, it is used in conjunction with the JH59. A JH58 includes the outside grip and deadbolt trim.



PARIS (shown in US15)
Available in: US3, US15



BARCELONA (shown in US15)
Available in: US3, US15

JH59

The JH59 is an interior facing deadbolt and knob/lever. It does not include any locking capabilities for the exterior. Therefore, it is used in conjunction with the JH58. The handing of the lockset is always viewed from the exterior of the door. The JH59 includes the inside knob or lever, inside deadbolt trim, deadbolt, latch, screws, and strikes.



BYRON (shown in US3)
Available in: US3



CORONA (shown in US3)
Available in: US3



LASALLE (shown in US3)
Available in: US3, US15



TORINO (shown in US15)
Available in: US3, US15

B-Series/F-Series/J-Series Available Finishes

Schlage's hardware finishes are designed to complement the fixtures and style in a home.

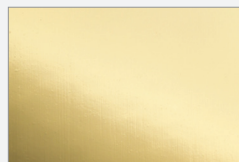

US3/US3LF
Bright Brass/Lifetime Brass
605/505

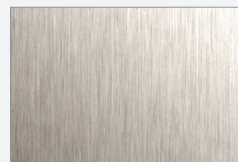

US15
Satin Nickel
619

F58

The F58 is an exterior facing handleset. It has locking capabilities, however, it does not include any interior lever or knob set. Therefore, it is used in conjunction with the F59. An F58 includes the grip outside deadbolt trim.



CAMELOT (shown in US15)
Available in: US3, US3LF,
US5, US15, US15A, 716
Aged Bronze



CENTURY (shown in US26D)
Available in: US26, US26D



PLYMOUTH (shown in US3LF)
Available in: US3, US3LF,
US5, US10B, US15, US15A,
US26, 716 Aged Bronze

F59

The F59 is an interior facing deadbolt and knob/lever. It does not include any locking capabilities for the exterior, therefore it is used in conjunction with the F58. The handing of the lockset is always viewed from the exterior of the door. The F59 includes the inside knob or lever, inside deadbolt trim, deadbolt, latch, screws, and strikes.



ACCENT (shown in US15A)
Available in: US3, US5,
US10B, US15, US15A, US26,
716 Aged Bronze



AVANTI (shown in US15)
Available in: US15



ELAN (shown in US26D)
Available in: US26D



FLAIR (shown in U3)
Available in: US3, US5,
US15, 716 Aged Bronze



GEORGIAN (shown in US15)
Available in: US3, US5,
US15, US15A,
716 Aged Bronze



PLYMOUTH (shown in Aged Bronze)
Available in: US3,
US15, US26, US26D,
716 Aged Bronze



SIENNA (shown in US15)
Available in: US15



BELL (shown in US3)
Available in: US3

F92

The F92 is a keyless dummy exterior facing handleset that complements the F58 handleset. It is used in conjunction with the F94.



CAMELOT (shown in US3LF)
Available in: US3, US3LF, US5, US10B, US15, US15A



CENTURY (shown in US26)
Available in: US26, US26D



PLYMOUTH (shown in US10B)
Available in: US3, US3LF, US5, US10B, US15, US15A, US26

F94

The F94 is an interior facing dummy knob/lever with a blank deadbolt plate that complements the F59 knob/lever. It is used in conjunction with the F92. The handing of the lockset is always viewed from the exterior of the door.



ACCENT (shown in US10B)
Available in: US3, US10B, US15, US15A, US26



FLAIR (shown in US5)
Available in: US3, US5, US10B, US15



GEORGIAN (shown in US3)
Available in: US3, US5, US15, US15A



PLYMOUTH (shown in US15)
Available in: US3, US15



SIENA (shown in US15)
Available in: US15

F-Series Available Finishes

Schlage's hardware finishes are designed to complement the fixtures and style in a home.

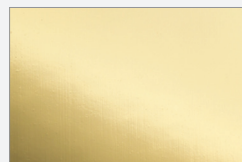

US3/US3LF
Bright Brass/Lifetime Brass
605/505

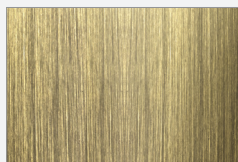

US5
Antique Brass
609

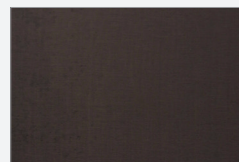

US10B
Oil Rubbed Bronze
613

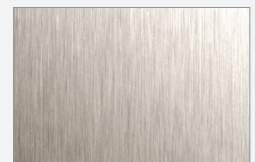

US15
Satin Nickel
619

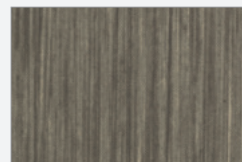

US15A
Antique Pewter
620

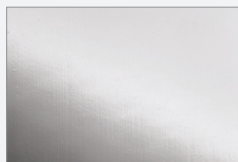

US26
Polished Chrome
625

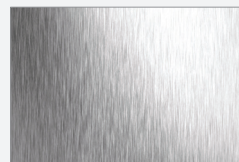

US26D
Satin Chrome
626

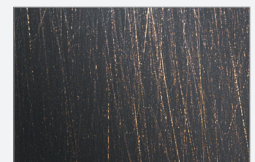

716
Aged Bronze
716

Schlage®

BE365

The BE365 is an electronic battery operated keypad deadbolt. It cannot stand alone as a locking system since it has no knob or lever to open the door. While it can be used with any knob or lever set, it is sold in conjunction with the FE285 handlesets as an entry door option.



CAMELOT (shown in US15)
Available in: US3LF, US15, 716
Aged Bronze



PLYMOUTH (shown in US3LF)
Available in: US3LF, US15,
716 Aged Bronze

FE285

The FE285 is a knob or lever set that has no locking capabilities which means it cannot stand alone. Therefore, it is used in conjunction with the BE365. Combined together, they create a front entry set. It is important to remember that the Accent and Flair levers are handed from the exterior view. The handing must be specified at the time of order. The FE285 is available in four different combinations. The exterior style is available to match the style of the BE365 while each style has an accompanying knob and lever available.



CAMELOT (Exterior)
ACCENT (Interior)
(shown in Aged Bronze)
Available in: US3LF, US15,
Aged Bronze



CAMELOT (Exterior)
GEORGIAN (Interior)
(shown in US15)
Available in: US3LF, US15,
Aged Bronze



PLYMOUTH (Exterior)
FLAIR (Interior)
(shown in US15)
Available in: US3LF, US15,
Aged Bronze



PLYMOUTH (Exterior)
PLYMOUTH (Interior)
(shown in US3LF)
Available in: US3LF



FE595

The FE595 is a stand alone electronic battery operated keypad entry which includes a knob or lever. This system can be set up so the door is always unlocked and must be manually locked. Another option is for the door to be unlocked by the user code and then once closed it automatically re-locks the exterior, while the interior is always unlocked. The key can be used to unlock the door as a backup. It is important to remember that the Accent and Flair levers are handed from the exterior view. The handing must be specified at the time of order.



CAMELOT Escutcheon
ACCENT Lever
(shown in US15)

Available in: US3LF, US15, Aged Bronze



CAMELOT Escutcheon
GEORGIAN Knob
(shown in Aged Bronze)

Available in: US3LF, US15, Aged Bronze



PLYMOUTH Escutcheon
FLAIR Lever
(shown in US15)

Available in: US3LF, US15, Aged Bronze



PLYMOUTH Escutcheon
PLYMOUTH Knob
(shown in US3LF)

Available in: US3LF

B-Series/F-Series Available Finishes

Schlage's hardware finishes are designed to complement the fixtures and style in a home.

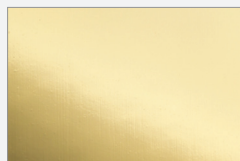

US3/US3LF
Bright Brass/Lifetime Brass
605/505

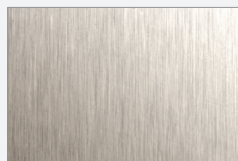

US15
Satin Nickel
619

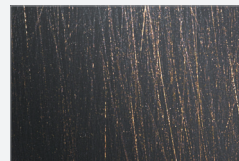

716
Aged Bronze
716

Custom Doors

Wood doors have very little limitations when it comes to design options. This catalog is a great resource for our in-stock items, however sometimes a different look is desired. Whether it is a modified stock item or a completely custom design, Reeb's Custom Design Team can help to create your ideal entryway. Not only will they help with your order, they ask questions along the way to help ensure your door will last.



Customer Sketch

Designing a custom door starts with the customer. A drawing or sketch is the best way to start the process. After submitting a sketch, our Custom Team will begin to help guide you through the quoting and buying process by asking about the following options:

Door Species: Beyond fir and mahogany, there is an entire array of wood species options available; among them are hemlock, cherry, maple, walnut, poplar, birch, red oak or white oak. Whether your tastes are classic or exotic, there is a wood species for you.

Glass Type: There are also many glass options available from clear glass allowing in the most abundant natural light to textured glass that is more opaque for a higher privacy level.

Door Width: Typical exterior doors range from 2'6" to 3'6" in width but Reeb has access to create doors up to 6'0" wide.

Door Height: Typical exterior doors range from 6'6" to 8'0" in height but Reeb has access to create doors up to 12'0" tall.

Door Thickness: 1-3/4" and 2-1/4" options are available in most species.

Creating a Custom Door... from idea to a reality

Once all the design decisions are picked, an initial CAD drawing is created based on the customer's sketch. Not only does this help the customer visualise the final product, but also helps to ensure the end product is what the customer desires.

The drawings are supplied to the customer for their review. Based on their needs, and the appearance of the door, the customer will then choose the layout and approve the purchase. The door is then ordered, and delivered to the customer.

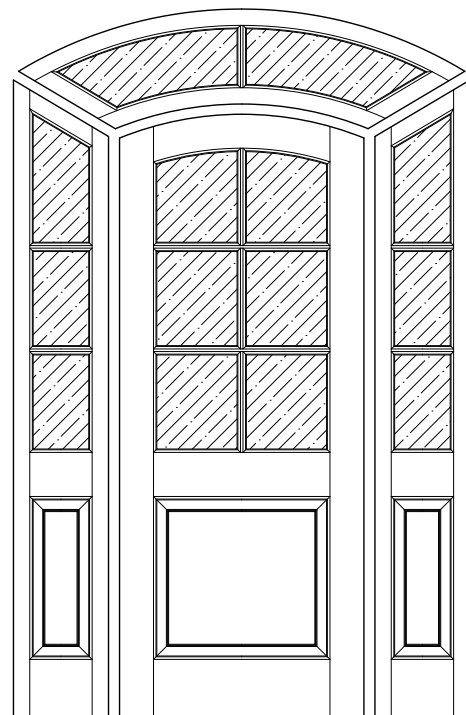

CAD Drawing



Custom Door Installed on a Home

Finally, the door arrives and is shipped to the customer. The customer can then have the door installed and complete their custom design process.

Custom Doors

Sometimes a desired design is not aesthetically pleasing because the components of the door do not line up. The CAD team will provide consultative quotes and drawings to show the possibilities available to the customer.

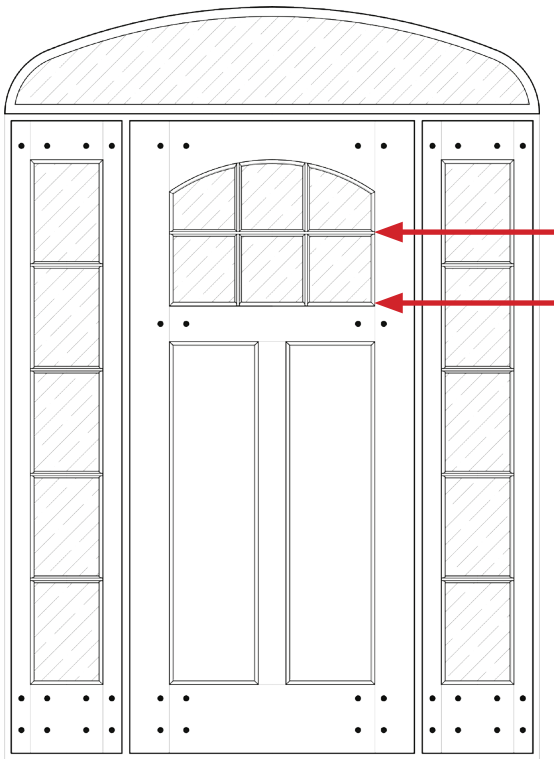

CAD Drawing based on Customer's Order

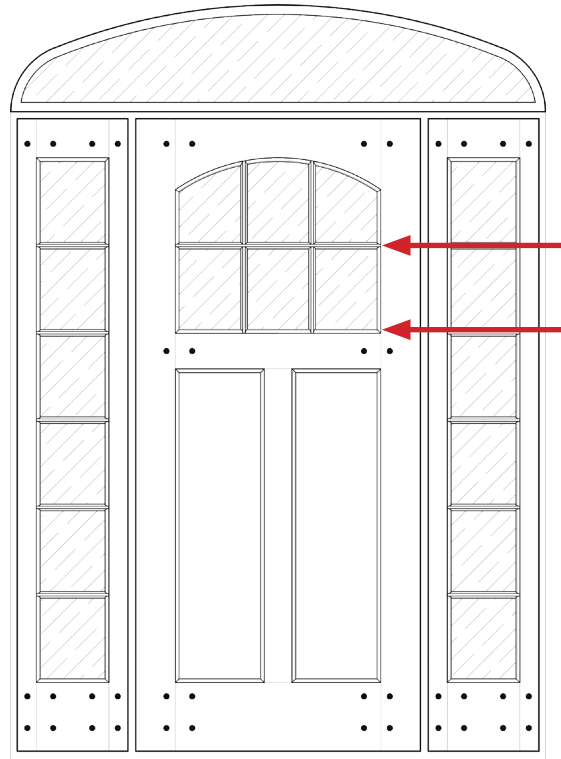

CAD Drawing considering aesthetics

Any wood. Any glass. Any size. Any style. Imagine the possibilities.





Stile & Rail Dimensions / Index

STYLE	TYPE	PAGE	HEIGHT	STILE	TOP RAIL	LOCK RAIL	BOTTOM RAIL	PANEL	BAR	GLASS	STICKING	MANUFACTURER
F1501	DOOR	63	8/0	4-1/2"	4-7/16"	---	9-3/16"	---	---	SAFETY	OVOLO	SIMPSON
F1510	DOOR	69	6/8	4-1/2"	4-7/16"	---	9-3/16"	---	1-1/4" TDL	SAFETY	OVOLO	SIMPSON
F1510	DOOR	69	7/0	4-1/2"	4-7/16"	---	9-3/16"	---	1-1/4" TDL	SAFETY	OVOLO	SIMPSON
F1512	DOOR	69	8/0	4-1/2"	4-7/16"	---	9-3/16"	---	1-1/4" TDL	SAFETY	OVOLO	SIMPSON
F1515	DOOR	69	6/8	4-1/2"	4-7/16"	---	9-3/16"	---	1-1/4" TDL	SAFETY	OVOLO	SIMPSON
F1515	DOOR	69	7/0	4-1/2"	6-7/16"	---	11-3/16"	---	1-1/4" TDL	SAFETY	OVOLO	SIMPSON
F1662	DOOR	53	6/8	4-1/2"	4-7/16"	---	9-3/16"	3/4" DHRP	1-1/4" TDL	SAFETY	OVOLO	SIMPSON
F2005	DOOR	53	6/8	4-1/2"	6-1/2"	5-3/8"	9-3/16"	3/4" DHRP	1-1/4" TDL	SAFETY	OVOLO	SIMPSON
F2010	DOOR	29	6/8	4-1/2"	4-7/16"	---	9-3/16"	3/4" DHRP	---	---	OVOLO	SIMPSON
F2035	SIDELITE	53	6/8	4-1/2"	4-7/16"	7-1/2"	9-3/16"	3/4" DHRP	1-1/4" TDL	SAFETY	OVOLO	SIMPSON
F2044	SIDELITE	28	6/8	4-1/2"	4-7/16"	7-1/2"	9-3/16"	3/4" DHRP	---	---	OVOLO	SIMPSON
F2055	DOOR	29	6/8	4-1/2"	4-7/16"	---	9-3/16"	3/4" DHRP	---	---	OVOLO	SIMPSON
F2055	DOOR	29	7/0	4-1/2"	6-7/16"	---	11-3/16"	3/4" DHRP	---	---	OVOLO	SIMPSON
F2060	DOOR	29	6/8	4-1/2"	4-7/16"	---	9-3/16"	3/4" DHRP	---	---	OVOLO	SIMPSON
F2130	DOOR	29	6/8	4-1/2"	4-7/16"	7-1/2"	9-3/16"	3/4" DHRP	---	---	OVOLO	SIMPSON
F2130	DOOR	29	7/0	4-1/2"	6-7/16"	7-1/2"	11-3/16"	3/4" DHRP	---	---	OVOLO	SIMPSON
F2132	DOOR	35	6/8	4-1/2"	4-7/16"	7-1/2"	9-3/16"	3/4" DHRP	---	SAFETY	OVOLO	SIMPSON
F2132	DOOR	35	7/0	4-1/2"	6-7/16"	7-1/2"	11-3/16"	3/4" DHRP	---	SAFETY	OVOLO	SIMPSON
F2134	DOOR	53	6/8	4-1/2"	4-7/16"	7-1/2"	9-3/16"	3/4" DHRP	1-1/4" TDL	SAFETY	OVOLO	SIMPSON
F3010	DOOR	27	6/8	5-1/2"	4-7/16"	---	9-3/16"	1-1/4" DHRP	---	---	OVOLO	SIMPSON
F3044	DOOR	27	6/8	5-1/2"	4-7/16"	7-1/2"	9-3/16"	1-1/4" DHRP	---	---	OVOLO	SIMPSON
F3130	DOOR	27	6/8	5-1/2"	4-7/16"	7-1/2"	9-3/16"	1-1/4" DHRP	---	---	OVOLO	SIMPSON
F318	DOOR	53	6/8	4-1/2"	4-7/16"	4-1/2"	9-3/16"	3/4" DHRP	1-1/4" TDL	SAFETY	OVOLO	SIMPSON
F37010LEW	DOOR	65	6/8	5-1/2"	4-7/16"	---	9-3/16"	---	7/8" SDL	LOW-E	OVOLO	SIMPSON
F37010LEW	DOOR	65	7/0	5-1/2"	6-7/16"	---	11-3/16"	---	7/8" SDL	LOW-E	OVOLO	SIMPSON
F37015LEW	DOOR	65	6/8	5-1/2"	4-7/16"	---	9-3/16"	---	7/8" SDL	LOW-E	OVOLO	SIMPSON
F37015LEW	DOOR	65	7/0	5-1/2"	6-7/16"	---	11-3/16"	---	7/8" SDL	LOW-E	OVOLO	SIMPSON
F37120	DOOR	45	6/8	5-1/2"	4-5/16"	---	9-3/16"	1-7/16" DHRP	7/8" SDL	INSULATED	OVOLO	SIMPSON
F37504LE	DOOR	45	8/0	5-1/2"	4-7/16"	7-1/2"	9-3/16"	1-7/16" DHRP	7/8" SDL	LOW-E	OVOLO	SIMPSON
F37506LE	DOOR	45	8/0	5-1/2"	4-7/16"	7-1/2"	9-3/16"	1-7/16" DHRP	7/8" SDL	LOW-E	OVOLO	SIMPSON

Stile & Rail Dimensions / Index

STYLE	TYPE	PAGE	HEIGHT	STILE	TOP RAIL	LOCK RAIL	BOTTOM RAIL	PANEL	BAR	GLASS	STICKING	MANUFACTURER
F37508LEW	DOOR	47	6/8	5-1/2"	4-7/16"	---	9-3/16"	1-7/16" DHRP	7/8" SDL	LOW-E	OVOLO	SIMPSON
F37508LEW	DOOR	47	7/0	5-1/2"	6-7/16"	---	11-3/16"	1-7/16" DHRP	7/8" SDL	LOW-E	OVOLO	SIMPSON
F37512LE	DOOR	47	8/0	5-1/2"	4-7/16"	7-1/2"	9-3/16"	1-7/16" DHRP	7/8" SDL	LOW-E	OVOLO	SIMPSON
F37662LE	DOOR	47	8/0	5-1/2"	4-7/16"	7-1/2"	9-3/16"	1-7/16" DHRP	7/8" SDL	LOW-E	OVOLO	SIMPSON
F37662LEW	DOOR	43	6/8	5-1/2"	4-7/16"	---	9-3/16"	1-7/16" DHRP	7/8" SDL	LOW-E	OVOLO	SIMPSON
F37663LEW	DOOR	43	6/8	2-29/32"	4-7/16"	---	9-11/16"	1-7/16" DHRP	7/8" SDL	LOW-E	OVOLO	SIMPSON
F37705LEW	SIDELITE	65	6/8	2-29/32"	4-7/16"	---	9-11/16"	---	7/8" SDL	LOW-E	OVOLO	SIMPSON
F37705LEW	SIDELITE	65	7/0	2-29/32"	6-7/16"	---	11-11/16"	---	7/8" SDL	LOW-E	OVOLO	SIMPSON
F37982LEW	DOOR	43	6/8	5-1/2"	4-7/16"	7-1/2"	9-3/16"	1-7/16" DHRP	7/8" SDL	LOW-E	OVOLO	SIMPSON
F37982LEW	DOOR	43	7/0	5-1/2"	6-7/16"	7-1/2"	11-3/16"	1-7/16" DHRP	7/8" SDL	LOW-E	OVOLO	SIMPSON
F418	DOOR	53	6/8	4-1/2"	4-7/16"	4-1/2"	9-3/16"	3/4" DHRP	1-1/4" TDL	SAFETY	OVOLO	SIMPSON
F4416V	DOOR	25	6/8	---	---	---	---	V-GROOVE	---	---	---	SIMPSON
F4416V	DOOR	25	7/0	---	---	---	---	V-GROOVE	---	---	---	SIMPSON
F6171	SIDELITE	39	6/8	2-29/32"	4-7/16"	---	9-11/16"	---	---	SOLANO	OVOLO	SIMPSON
F6175	SIDELITE	37	6/8	2-29/32"	4-7/16"	---	9-11/16"	3/4" FP	---	INSULATED	OVOLO	SIMPSON
F6175LE	SIDELITE	36	6/8	2-29/32"	4-7/16"	---	9-11/16"	3/4" FP	---	LOW-E	OVOLO	SIMPSON
F6422	DOOR	63	6/8	5-1/2"	4-9/16"	---	9-3/16"	---	---	TERRACE RIDGE	OVOLO	SIMPSON
F6422	DOOR	63	7/0	5-1/2"	6-7/16"	---	11-3/16"	---	---	TERRACE RIDGE	OVOLO	SIMPSON
F6423	SIDELITE	63	6/8	3"	4-7/16"	---	9-11/16"	---	---	TERRACE RIDGE	OVOLO	SIMPSON
F6423	SIDELITE	63	7/0	3"	6-7/16"	---	11-11/16"	---	---	TERRACE RIDGE	OVOLO	SIMPSON
F6490	DOOR	34	6/8	6"	5-9/16"	7-1/2"	9-3/16"	1-7/16" DHRP	---	SANTA FE	OVOLO	SIMPSON
F6490	DOOR	34	7/0	6"	7-9/16"	7-1/2"	11-3/16"	1-7/16" DHRP	---	SANTA FE	OVOLO	SIMPSON
F6493	SIDELITE	34	6/8	3-1/2"	5-9/16"	---	9-11/16"	1-7/16" DHRP	---	SANTA FE	OVOLO	SIMPSON
F6493	SIDELITE	34	7/0	3-1/2"	7-9/16"	---	11-11/16"	1-7/16" DHRP	---	SANTA FE	OVOLO	SIMPSON
F6801	DOOR	37	6/8	5-1/2"	4-7/16"	---	9-3/16"	3/4" FP	---	INSULATED	OVOLO	SIMPSON
F6801	DOOR	37	8/0	5-1/2"	4-7/16"	---	9-3/16"	3/4" FP	---	INSULATED	OVOLO	SIMPSON
F6801LE	DOOR	36	6/8	5-1/2"	4-7/16"	---	9-3/16"	3/4" FP	---	LOW-E	OVOLO	SIMPSON
F6801LE	DOOR	36	8/0	5-1/2"	4-7/16"	---	9-3/16"	3/4" FP	---	LOW-E	OVOLO	SIMPSON
F6803	DOOR	55	6/8	5-1/2"	4-7/16"	---	9-3/16"	3/4" FP	1-3/8" TDL	INSULATED	OVOLO	SIMPSON
F6803LE	DOOR	55	6/8	5-1/2"	4-7/16"	---	9-3/16"	3/4" FP	1-3/8" TDL	LOW-E	OVOLO	SIMPSON

Stile & Rail Dimensions / Index

STYLE	TYPE	PAGE	HEIGHT	STILE	TOP RAIL	LOCK RAIL	BOTTOM RAIL	PANEL	BAR	GLASS	STICKING	MANUFACTURER
F6841	DOOR	39	6/8	5-1/2"	4-7/16"	---	9-3/16"	3/4" FP	---	SOLANO	OVOLO	SIMPSON
F6841	DOOR	39	6/8	5-1/2"	4-7/16"	---	9-3/16"	3/4" FP	---	SOLANO	OVOLO	SIMPSON
F6861	DOOR	37	6/8	5-1/2"	4-7/16"	---	9-3/16"	3/4" FP	---	INSULATED	OVOLO	SIMPSON
F6861	DOOR	37	8/0	5-1/2"	4-7/16"	---	9-3/16"	3/4" FP	---	INSULATED	OVOLO	SIMPSON
F6861LE	DOOR	37	6/8	5-1/2"	4-7/16"	---	9-3/16"	3/4" FP	---	LOW-E	OVOLO	SIMPSON
F6861LE	DOOR	37	8/0	5-1/2"	4-7/16"	---	9-3/16"	3/4" FP	---	LOW-E	OVOLO	SIMPSON
F6881	DOOR	39	6/8	5-1/2"	4-7/16"	---	9-3/16"	3/4" FP	---	SOLANO	OVOLO	SIMPSON
F6881	DOOR	39	8/0	5-1/2"	4-7/16"	---	9-3/16"	3/4" FP	---	SOLANO	OVOLO	SIMPSON
F7001	DOOR	62	6/8	4-1/2"	4-7/16"	---	9-3/16"	---	---	INSULATED	OVOLO	SIMPSON
F7001	DOOR	62	7/0	4-1/2"	4-7/16"	---	9-3/16"	---	---	INSULATED	OVOLO	SIMPSON
F7001	DOOR	62	8/0	4-1/2"	4-7/16"	---	9-3/16"	---	---	INSULATED	OVOLO	SIMPSON
F7002LE	DOOR	63	6/8	5-1/2"	4-7/16"	---	9-3/16"	---	---	LOW-E	OVOLO	SIMPSON
F7002LE	DOOR	63	8/0	5-1/2"	4-7/16"	---	9-3/16"	---	---	LOW-E	OVOLO	SIMPSON
F7002LEW	DOOR	61	6/8	5-1/2"	4-7/16"	---	9-3/16"	---	---	LOW-E	OVOLO	SIMPSON
F7002LEW	DOOR	61	8/0	5-1/2"	4-7/16"	---	9-3/16"	---	---	LOW-E	OVOLO	SIMPSON
F37010	DOOR	66	6/8	4-1/2"	4-7/16"	---	9-3/16"	---	7/8" SDL	INSULATED	OVOLO	SIMPSON
F37010	DOOR	66	7/0	4-1/2"	4-7/16"	---	9-3/16"	---	7/8" SDL	INSULATED	OVOLO	SIMPSON
F37015	DOOR	66	6/8	5-1/2"	4-7/16"	---	9-3/16"	---	7/8" SDL	INSULATED	OVOLO	SIMPSON
F37015	DOOR	66	7/0	5-1/2"	4-7/16"	---	9-3/16"	---	7/8" SDL	INSULATED	OVOLO	SIMPSON
F7031LE	DOOR	33	6/8	5-1/2"	4-7/16"	7-1/2"	9-3/16"	1-7/16" DHRP	---	LOW-E	OVOLO	SIMPSON
F7037LE	DOOR	62	8/0	5-1/2"	4-7/16"	---	9-3/16"	---	---	LOW-E	OVOLO	SIMPSON
F7037W	DOOR	61	6/8	5-1/2"	6-7/16"	---	18-1/2"	---	---	INSULATED	OVOLO	SIMPSON
F7037W	DOOR	61	7/0	5-1/2"	6-7/16"	---	18-1/2"	---	---	INSULATED	OVOLO	SIMPSON
F7044LE	DOOR	32	6/8	4-1/2"	4-7/16"	7-1/2"	9-3/16"	1-7/16" DHRP	---	LOW-E	OVOLO	SIMPSON
F7044LE	DOOR	32	8/0	4-1/2"	4-7/16"	7-1/2"	9-3/16"	1-7/16" DHRP	---	LOW-E	OVOLO	SIMPSON
F7044LEW	DOOR	31	6/8	5-1/2"	4-7/16"	7-1/2"	9-3/16"	1-7/16" DHRP	---	LOW-E	OVOLO	SIMPSON
F7044LEW	DOOR	31	7/0	5-1/2"	6-7/16"	7-1/2"	11-3/16"	1-7/16" DHRP	---	LOW-E	OVOLO	SIMPSON
F7081LEW	DOOR	31	6/8	5-1/2"	4-7/16"	7-1/2"	9-3/16"	1-7/16" DHRP	---	LOW-E	OVOLO	SIMPSON
F7081LEW	DOOR	31	7/0	5-1/2"	6-7/16"	7-1/2"	11-3/16"	1-7/16" DHRP	---	LOW-E	OVOLO	SIMPSON
F37109	DOOR	67	6/8	5-1/2"	4-7/16"	---	9-3/16"	---	7/8" SDL	INSULATED	OVOLO	SIMPSON

Stile & Rail Dimensions / Index

STYLE	TYPE	PAGE	HEIGHT	STILE	TOP RAIL	LOCK RAIL	BOTTOM RAIL	PANEL	BAR	GLASS	STICKING	MANUFACTURER
F37109	DOOR	67	7/0	5-1/2"	6-7/16"	---	11-3/16"	---	7/8" SDL	INSULATED	OVOLO	SIMPSON
F7130	DOOR	23	7/0	5-1/2"	4-7/16"	7-1/2"	9-3/16"	1-7/16" DHRP	---	---	OVOLO	SIMPSON
F7130	DOOR	23	6/8	5-1/2"	4-7/16"	7-1/2"	9-3/16"	1-7/16" DHRP	---	---	OVOLO	SIMPSON
F7130	DOOR	23	8/0	5-1/2"	4-7/16"	7-1/2"	9-3/16"	1-7/16" DHRP	---	---	OVOLO	SIMPSON
F7132	DOOR	33	6/8	5-1/2"	4-7/16"	7-1/2"	9-3/16"	1-7/16" DHRP	---	INSULATED	OVOLO	SIMPSON
F7132	DOOR	33	7/0	5-1/2"	4-7/16"	7-1/2"	9-3/16"	1-7/16" DHRP	---	INSULATED	OVOLO	SIMPSON
F37134	DOOR	47	6/8	5-1/2"	4-7/16"	7-1/2"	9-3/16"	1-7/16" DHRP	7/8" SDL	INSULATED	OVOLO	SIMPSON
F37134	DOOR	47	7/0	5-1/2"	4-7/16"	7-1/2"	9-3/16"	1-7/16" DHRP	7/8" SDL	INSULATED	OVOLO	SIMPSON
F37212	DOOR	49	6/8	5-1/2"	4-7/16"	7-1/2"	9-3/16"	1-7/16" DHRP	7/8" SDL	LOW-E	OVOLO	SIMPSON
F37213	DOOR	49	6/8	2-29/32"	4-7/16"	---	9-11/16"	1-7/16" DHRP	7/8" SDL	LOW-E	OVOLO	SIMPSON
F37214	DOOR	49	6/8	5-1/2"	4-7/16"	7-1/2"	9-3/16"	1-7/16" DHRP	7/8" SDL	LOW-E	OVOLO	SIMPSON
F37215	SIDELITE	49	6/8	2-29/32"	4-7/16"	---	9-11/16"	1-7/16" DHRP	7/8" SDL	LOW-E	OVOLO	SIMPSON
F37215	SIDELITE	49	7/0	2-29/32"	4-7/16"	---	9-11/16"	1-7/16" DHRP	7/8" SDL	LOW-E	OVOLO	SIMPSON
F37216	DOOR	49	6/8	5-1/2"	4-7/16"	---	9-3/16"	1-7/16" DHRP	7/8" SDL	LOW-E	OVOLO	SIMPSON
F37217	SIDELITE	49	6/8	2-29/32"	4-7/16"	---	9-11/16"	1-7/16" DHRP	7/8" SDL	LOW-E	OVOLO	SIMPSON
F37218	DOOR	49	6/8	5-1/2"	4-7/16"	---	9-3/16"	1-7/16" DHRP	7/8" SDL	LOW-E	OVOLO	SIMPSON
F37219	SIDELITE	48	6/8	2-29/32"	4-7/16"	---	9-11/16"	1-7/16" DHRP	7/8" SDL	LOW-E	OVOLO	SIMPSON
F37219	SIDELITE	48	7/0	2-29/32"	4-7/16"	---	9-11/16"	1-7/16" DHRP	7/8" SDL	LOW-E	OVOLO	SIMPSON
F37222	DOOR	49	6/8	5-1/2"	4-7/16"	---	9-3/16"	1-7/16" DHRP	7/8" SDL	LOW-E	OVOLO	SIMPSON
F37224	DOOR	49	6/8	5-1/2"	4-7/16"	7-1/2"	9-3/16"	1-7/16" DHRP	7/8" SDL	LOW-E	OVOLO	SIMPSON
F37224	DOOR	49	7/0	5-1/2"	4-7/16"	7-1/2"	9-3/16"	1-7/16" DHRP	7/8" SDL	LOW-E	OVOLO	SIMPSON
F37226	DOOR	49	6/8	5-1/2"	4-7/16"	---	9-3/16"	1-7/16" DHRP	7/8" SDL	LOW-E	OVOLO	SIMPSON
F37228	DOOR	48	6/8	5-1/2"	4-7/16"	---	9-3/16"	1-7/16" DHRP	7/8" SDL	LOW-E	OVOLO	SIMPSON
F37228	DOOR	48	7/0	5-1/2"	4-7/16"	---	9-3/16"	1-7/16" DHRP	7/8" SDL	LOW-E	OVOLO	SIMPSON
F7260	SIDELITE	51	6/8	3-3/4"	5-9/16"	---	9-11/16"	1-7/16" DHRP	2-3/4" TD	INSULATED	OVOLO	SIMPSON
F7260	SIDELITE	51	7/0	3-3/4"	5-9/16"	---	9-11/16"	1-7/16" DHRP	2-3/4" TD	INSULATED	OVOLO	SIMPSON
F7260LE	SIDELITE	51	8/0	3-3/4"	5-9/16"	---	9-11/16"	1-7/16" DHRP	2-3/4" TD	LOW-E	OVOLO	SIMPSON
F7304	DOOR	24	6/8	5-1/2"	4-7/16"	7-1/2"	9-3/16"	1-7/16" DHRP	---	---	OVOLO	SIMPSON
F7304	DOOR	24	7/0	5-1/2"	4-7/16"	7-1/2"	9-3/16"	1-7/16" DHRP	---	---	OVOLO	SIMPSON
F7304	DOOR	24	8/0	5-1/2"	4-7/16"	7-1/2"	9-3/16"	1-7/16" DHRP	---	---	OVOLO	SIMPSON

Stile & Rail Dimensions / Index

STYLE	TYPE	PAGE	HEIGHT	STILE	TOP RAIL	LOCK RAIL	BOTTOM RAIL	PANEL	BAR	GLASS	STICKING	MANUFACTURER
F7326	DOOR	24	6/8	5-1/2"	4-7/16"	---	9-3/16"	1-7/16" DHRP	---	---	OVOLO	SIMPSON
F7403LEE	DOOR	59	6/8	5-1/2"	4-7/16"	---	9-3/16"	---	---	SATIN ETCH	SHAKER	SIMPSON
F7404LEE	DOOR	59	6/8	5-1/2"	4-7/16"	---	9-3/16"	---	---	SATIN ETCH	SHAKER	SIMPSON
F7404LEE	DOOR	59	6/8	5-1/2"	4-7/16"	---	9-3/16"	---	---	SATIN ETCH	SHAKER	SIMPSON
F7405LEE	DOOR	59	6/8	5-1/2"	4-7/16"	---	9-3/16"	---	---	SATIN ETCH	SHAKER	SIMPSON
F7406LEE	DOOR	59	8/0	5-1/2"	4-7/16"	---	9-3/16"	---	---	SATIN ETCH	SHAKER	SIMPSON
F7501LE	DOOR	33	6/8	5-1/2"	4-7/16"	7-1/2"	9-3/16"	1-7/16" DHRP	---	LOW-E	OVOLO	SIMPSON
F7501LE	DOOR	33	8/0	5-1/2"	4-7/16"	7-1/2"	9-3/16"	1-7/16" DHRP	---	LOW-E	OVOLO	SIMPSON
F7501LEW	DOOR	31	6/8	5-1/2"	4-7/16"	7-1/2"	9-3/16"	1-7/16" DHRP	---	LOW-E	OVOLO	SIMPSON
F7501LEW	DOOR	31	7/0	5-1/2"	6-7/16"	7-1/2"	11-3/16"	1-7/16" DHRP	---	LOW-E	OVOLO	SIMPSON
F37508	DOOR	47	6/8	5-1/2"	4-7/16"	7-1/2"	9-3/16"	1-7/16" DHRP	7/8" SDL	INSULATED	OVOLO	SIMPSON
F37508	DOOR	47	7/0	5-1/2"	4-7/16"	7-1/2"	9-3/16"	1-7/16" DHRP	7/8" SDL	INSULATED	OVOLO	SIMPSON
F37512	DOOR	47	6/8	5-1/2"	4-7/16"	7-1/2"	9-3/16"	1-7/16" DHRP	7/8" SDL	INSULATED	OVOLO	SIMPSON
F37512	DOOR	47	7/0	5-1/2"	4-7/16"	7-1/2"	9-3/16"	1-7/16" DHRP	7/8" SDL	INSULATED	OVOLO	SIMPSON
F7598	DOOR	50	6/8	5-1/2"	4-7/16"	7-1/2"	9-3/16"	1-7/16" DHRP	1-3/8" TDL	BEVELED	OVOLO	SIMPSON
F7598	DOOR	500	7/0	5-1/2"	4-7/16"	7-1/2"	9-3/16"	1-7/16" DHRP	1-3/8" TDL	BEVELED	OVOLO	SIMPSON
F7599	SIDELITE	50	6/8	2-29/32"	4-7/16"	---	9-11/16"	1-7/16" DHRP	1-3/8" TDL	BEVELED	OVOLO	SIMPSON
F7599	SIDELITE	50	7/0	2-29/32"	4-7/16"	---	9-11/16"	1-7/16" DHRP	1-3/8" TDL	BEVELED	OVOLO	SIMPSON
F37662LE	DOOR	45	7/0	5-1/2"	4-7/16"	---	9-3/16"	1-7/16" DHRP	7/8" SDL	LOW-E	OVOLO	SIMPSON
F37662LE	DOOR	45	6/8	5-1/2"	4-7/16"	---	9-3/16"	1-7/16" DHRP	7/8" SDL	LOW-E	OVOLO	SIMPSON
F37663LE	SIDELITE	47	7/0	2-29/32"	4-7/16"	---	9-11/16"	1-7/16" DHRP	7/8" SDL	LOW-E	OVOLO	SIMPSON
F37663LE	SIDELITE	47	6/8	2-29/32"	4-7/16"	---	9-11/16"	1-7/16" DHRP	7/8" SDL	LOW-E	OVOLO	SIMPSON
F77002	DOOR	60	6/8	5-1/2"	5-7/16"	---	9-3/16"	---	---	LOW-E	OVOLO	SIMPSON
F7701	SIDELITE	62	6/8	2-29/32"	4-7/16"	---	9-11/16"	---	---	INSULATED	OVOLO	SIMPSON
F7701	SIDELITE	62	7/0	2-29/32"	4-7/16"	---	9-11/16"	---	---	INSULATED	OVOLO	SIMPSON
F77015	DOOR	64	6/8	5-1/2"	5-7/16"	---	9-3/16"	---	7/8" SDL	LOW-E	OVOLO	SIMPSON
F7701LE	SIDELITE	63	6/8	2-29/32"	4-7/16"	---	9-7/8"	---	---	LOW-E	OVOLO	SIMPSON
F7701LE	SIDELITE	63	6/8	2-29/32"	6-7/16"	---	11-7/8"	---	---	LOW-E	OVOLO	SIMPSON
F7701LE	SIDELITE	63	7/0	2-29/32"	4-7/16"	---	9-7/8"	---	---	LOW-E	OVOLO	SIMPSON
F7701LEE	SIDELITE	59	6/8	2-29/32"	4-7/16"	---	9-11/16"	---	---	SATIN ETCH	SHAKER	SIMPSON

Stile & Rail Dimensions / Index

STYLE	TYPE	PAGE	HEIGHT	STILE	TOP RAIL	LOCK RAIL	BOTTOM RAIL	PANEL	BAR	GLASS	STICKING	MANUFACTURER
F7701LEE	SIDELITE	59	8/0	2-29/32"	4-7/16"	---	9-11/16"	---	---	SATIN ETCH	SHAKER	SIMPSON
F7701LEW	SIDELITE	61	6/8	2-29/32"	4-7/16"	---	9-11/16"	---	---	LOW-E	OVOLO	SIMPSON
F7701LEW	SIDELITE	61	7/0	2-29/32"	6-7/16"	---	11-11/16"	---	---	LOW-E	OVOLO	SIMPSON
F7702	SIDELITE	32	6/8	2-29/32"	4-7/16"	---	9-11/16"	1-7/16" DHRP	---	INSULATED	OVOLO	SIMPSON
F7702LE	SIDELITE	32	8/0	2-29/32"	4-7/16"	---	9-11/16"	1-7/16" DHRP	---	LOW-E	OVOLO	SIMPSON
F37703	SIDELITE	46	6/8	2-29/32"	4-7/16"	---	9-11/16"	1-7/16" DHRP	7/8" SDL	INSULATED	OVOLO	SIMPSON
F37703	SIDELITE	46	7/0	2-29/32"	4-7/16"	---	9-11/16"	1-7/16" DHRP	7/8" SDL	INSULATED	OVOLO	SIMPSON
F37705	SIDELITE	66	6/8	2-29/32"	4-7/16"	---	9-11/16"	---	7/8" SDL	INSULATED	OVOLO	SIMPSON
F37705	SIDELITE	66	7/0	2-29/32"	4-7/16"	---	9-11/16"	---	7/8" SDL	INSULATED	OVOLO	SIMPSON
F37709	SIDELITE	67	6/8	2-29/32"	4-7/16"	---	9-11/16"	---	7/8" SDL	INSULATED	OVOLO	SIMPSON
F37709	SIDELITE	67	7/0	2-29/32"	6-7/16"	---	11-11/16"	---	7/8" SDL	INSULATED	OVOLO	SIMPSON
F7711LE	TRANSOM	72	1/0 (12")	1-29/32"	2-29/32"	---	2-29/32"	---	---	LOW-E	OVOLO	SIMPSON
F77130	DOOR	21	6/8	5-1/2"	5-7/16"	7-1/2"	9-3/16"	1-7/16" DHRP	---	---	OVOLO	SIMPSON
F77144	DOOR	21	6/8	5-1/2"	5-7/16"	7-1/2"	9-3/16"	1-7/16" DHRP	---	---	OVOLO	SIMPSON
F37715	TRANSOM	72	1/0 (12")	1-29/32"	2-29/32"	---	2-29/32"	---	7/8" SDL	INSULATED	OVOLO	SIMPSON
F77212	DOOR	41	6/8	5-1/2"	5-7/16"	---	9-3/16"	1-7/16" DHRP	7/8" SDL	LOW-E	OVOLO	SIMPSON
F37725	TRANSOM	72	1/0 (12")	2-29/32"	2-29/32"	---	2-29/32"	---	7/8" SDL	INSULATED	OVOLO	SIMPSON
F77260	SIDELITE	54	6/8	2-29/32"	5-7/16"	---	9-3/16"	3/4" FP	2-3/4" TD	LOW-E	OVOLO	SIMPSON
F37743	TRANSOM	72	1/0 (12")	4-1/2"	2-29/32"	---	2-29/32"	---	7/8" SDL	INSULATED	OVOLO	SIMPSON
F2774560	TRANSOM	72	1/0 (12")	4-1/2"	2-29/32"	---	2-29/32"	---	1-3/8" TD	INSULATED	OVOLO	SIMPSON
F77465	DOOR	21	6/8	5-1/2"	5-7/16"	7-1/2"	9-3/16"	1-7/16" DHRP	---	---	OVOLO	SIMPSON
F7751	TRANSOM	72	1/0 (12")	5-1/2"	2-29/32"	---	2-29/32"	---	---	INSULATED	OVOLO	SIMPSON
F7751LE	TRANSOM	72	1/0 (12")	5-1/2"	2-29/32"	---	2-29/32"	---	---	LOW-E	OVOLO	SIMPSON
F37753	TRANSOM	72	1/0 (12")	5-1/2"	2-29/32"	---	2-29/32"	---	7/8" SDL	INSULATED	OVOLO	SIMPSON
F37755	TRANSOM	72	1/2 (14")	5-1/2"	2-29/32"	---	2-29/32"	---	7/8" SDL	INSULATED	OVOLO	SIMPSON
F77598	DOOR	41	6/8	5-1/2"	5-7/16"	---	9-3/16"	1-7/16" DHRP	7/8" SDL	LOW-E	OVOLO	SIMPSON
F77599	SIDELITE	41	6/8	2-29/32"	5-7/16"	---	9-11/16"	1-7/16" DHRP	7/8" SDL	LOW-E	OVOLO	SIMPSON
F77660	DOOR	57	6/8	5-1/2"	5-7/16"	---	9-3/16"	3/4" FP	7/8" SDL	LOW-E	OVOLO	SIMPSON
F77662	DOOR	41	6/8	5-1/2"	5-7/16"	---	9-3/16"	1-7/16" DHRP	7/8" SDL	LOW-E	OVOLO	SIMPSON
F77663	SIDELITE	57	6/8	2-29/32"	5-7/16"	---	9-11/16"	1-7/16" DHRP	7/8" SDL	LOW-E	OVOLO	SIMPSON

Stile & Rail Dimensions / Index

STYLE	TYPE	PAGE	HEIGHT	STILE	TOP RAIL	LOCK RAIL	BOTTOM RAIL	PANEL	BAR	GLASS	STICKING	MANUFACTURER
F77663RP	SIDELITE	41	6/8	2-29/32"	5-7/16"	---	9-11/16"	1-7/16" DHRP	7/8" SDL	LOW-E	OVOLO	SIMPSON
F77701	SIDELITE	60	6/8	2-29/32"	5-7/16"	---	9-11/16"	---	---	LOW-E	OVOLO	SIMPSON
F77703	SIDELITE	41	6/8	2-29/32"	5-7/16"	---	9-11/16"	1-7/16" DHRP	7/8" SDL	LOW-E	OVOLO	SIMPSON
F77705	SIDELITE	64	6/8	2-29/32"	5-7/16"	---	9-11/16"	---	7/8" SDL	LOW-E	OVOLO	SIMPSON
F77804	SIDELITE	41	6/8	2-29/32"	5-7/16"	---	9-11/16"	1-7/16" DHRP	7/8" SDL	LOW-E	OVOLO	SIMPSON
F77860	DOOR	54	6/8	5-1/2"	5-7/16"	---	9-3/16"	3/4" FP	2-3/4" TDL	LOW-E	OVOLO	SIMPSON
F77944	DOOR	41	6/8	5-1/2"	5-7/16"	7-1/2"	9-3/16"	1-7/16" DHRP	7/8" SDL	LOW-E	OVOLO	SIMPSON
F7801LE	SIDELITE	33	6/8	2-29/32"	4-7/16"	---	9-11/16"	1-7/16" DHRP	---	LOW-E	OVOLO	SIMPSON
F7801LE	SIDELITE	33	8/0	2-29/32"	4-7/16"	---	9-11/16"	1-7/16" DHRP	---	LOW-E	OVOLO	SIMPSON
F7801LEW	SIDELITE	31	6/8	2-29/32"	4-7/16"	---	9-11/16"	1-7/16" DHRP	---	LOW-E	OVOLO	SIMPSON
F7801LEW	DOOR	31	7/0	2-29/32"	6-7/16"	---	11-11/16"	1-7/16" DHRP	---	LOW-E	OVOLO	SIMPSON
F37804	SIDELITE	47	6/8	2-29/32"	4-7/16"	---	9-11/16"	1-7/16" DHRP	7/8" SDL	INSULATED	OVOLO	SIMPSON
F37804	SIDELITE	47	7/0	2-29/32"	4-7/16"	---	9-11/16"	1-7/16" DHRP	7/8" SDL	INSULATED	OVOLO	SIMPSON
F7860	DOOR	51	6/8	5-1/2"	5-9/16"	---	9-3/16"	1-7/16" DHRP	2-3/4" TDL	INSULATED	OVOLO	SIMPSON
F7860	DOOR	51	7/0	5-1/2"	7-9/16"	---	11-3/16"	1-7/16" DHRP	2-3/4" TDL	INSULATED	OVOLO	SIMPSON
F7860LE	DOOR	51	8/0	5-1/2"	5-9/16"	---	9-3/16"	1-7/16" DHRP	2-3/4" TDL	LOW-E	OVOLO	SIMPSON
F37944	DOOR	46	6/8	4-1/2"	4-7/16"	7-1/2"	9-3/16"	1-7/16" DHRP	7/8" SDL	INSULATED	OVOLO	SIMPSON
F37944	DOOR	46	7/0	4-1/2"	4-7/16"	7-1/2"	9-3/16"	1-7/16" DHRP	7/8" SDL	INSULATED	OVOLO	SIMPSON
F944	DOOR	53	6/8	4-1/2"	4-7/16"	7-1/2"	9-3/16"	3/4" DHRP	1-1/4" TDL	SAFETY	OVOLO	SIMPSON
FD2011	DOOR	71	6/8	4-1/2"	4-7/16"	6-7/8"	9-3/16"	1-7/16" DHRP	7/8" SDL	INSULATED	OVOLO	SIMPSON
FD2013	DOOR	71	6/8	4-1/2"	4-7/16"	6-7/8"	9-3/16"	1-7/16" DHRP	7/8" SDL	INSULATED	OVOLO	SIMPSON
FD4011	DOOR	71	6/8	4-1/2"	4-7/16"	6-7/8"	9-3/16"	1-7/16" DHRP	---	---	OVOLO	SIMPSON
FD4013	DOOR	71	6/8	4-1/2"	4-7/16"	6-7/8"	9-3/16"	1-7/16" DHRP	---	---	OVOLO	SIMPSON
MF7230	DOOR	23	6/8	5-1/2"	4-7/16"	---	9-3/16"	1-7/16" DHRP	---	---	OVOLO	SIMPSON
MF7230	DOOR	23	8/0	5-1/2"	5-1/2"	---	9-3/16"	1-7/16" DHRP	---	---	OVOLO	SIMPSON
MF7282	DOOR	23	6/8	5-1/2"	4-7/16"	7-1/2"	9-3/16"	1-7/16" DHRP	---	---	OVOLO	SIMPSON
MF7282	DOOR	23	8/0	5-1/2"	5-1/2"	7-1/2"	9-3/16"	1-7/16" DHRP	---	---	OVOLO	SIMPSON
MF7465	DOOR	23	6/8	5-1/2"	8"	7-1/2"	9-3/16"	1-7/16" DHRP	---	---	OVOLO	SIMPSON
MF7465	DOOR	23	8/0	5-1/2"	8"	7-1/2"	9-3/16"	1-7/16" DHRP	---	---	OVOLO	SIMPSON
MF7466	DOOR	23	6/8	5-1/2"	8"	7-1/2"	9-3/16"	1-7/16" DHRP	---	---	OVOLO	SIMPSON

Stile & Rail Dimensions / Index

STYLE	TYPE	PAGE	HEIGHT	STILE	TOP RAIL	LOCK RAIL	BOTTOM RAIL	PANEL	BAR	GLASS	STICKING	MANUFACTURER
MF7467	DOOR	23	6/8	5-1/2"	8"	7-1/2"	9-3/16"	1-7/16" DHRP	---	---	OVOLO	SIMPSON
MF7701	SIDELITE	23	6/8	2-29/32"	4-7/16"	---	9-11/16"	---	---	LOW-E	OVOLO	SIMPSON
MF7701	SIDELITE	23	8/0	2-29/32"	5-1/2"	---	9-11/16"	---	---	LOW-E	OVOLO	SIMPSON
MSM7230M	DOOR	75	6/8	5-1/2"	4-7/16"	---	9-3/16"	1-7/16" DHRP	---	---	OVOLO	SIMPSON
MSM7282	DOOR	75	6/8	5-1/2"	4-7/16"	7-1/2"	9-3/16"	1-7/16" DHRP	---	---	OVOLO	SIMPSON
MSM7282	DOOR	75	8/0	5-1/2"	5-1/2"	7-1/2"	9-3/16"	1-7/16" DHRP	---	---	OVOLO	SIMPSON
MSM7282M	DOOR	75	6/8	5-1/2"	4-7/16"	7-1/2"	9-3/16"	1-7/16" DHRP	---	---	OVOLO	SIMPSON
MSM7282M	DOOR	75	8/0	5-1/2"	5-1/2"	7-1/2"	9-3/16"	1-7/16" DHRP	---	---	OVOLO	SIMPSON
MSM7465	DOOR	75	6/8	5-1/2"	8"	7-1/2"	9-3/16"	1-7/16" DHRP	---	---	OVOLO	SIMPSON
MSM7465	DOOR	75	8/0	5-1/2"	8"	7-1/2"	9-3/16"	1-7/16" DHRP	---	---	OVOLO	SIMPSON
MSM7701	SIDELITE	75	6/8	2-29/32"	4-7/16"	---	9-11/16"	---	---	LOW-E	OVOLO	SIMPSON
MSM7701	SIDELITE	75	8/0	2-29/32"	4-7/16"	---	9-11/16"	---	---	LOW-E	OVOLO	SIMPSON
O7130	DOOR	92	6/8	5-1/2"	4-7/16"	7-1/2"	9-3/16"	1-7/16" DHRP	---	---	OVOLO	SIMPSON
O7344	DOOR	92	6/8	5-1/2"	4-7/16"	7-1/2"	9-3/16"	1-7/16" DHRP	---	---	OVOLO	SIMPSON
O37703	SIDELITE	93	6/8	2-29/32"	4-7/16"	7-1/2"	9-11/16"	1-7/16" DHRP	7/8" SDL	INSULATED	OVOLO	SIMPSON
O37944	DOOR	93	6/8	5-1/2"	4-7/16"	7-1/2"	9-3/16"	1-7/16" DHRP	7/8" SDL	INSULATED	OVOLO	SIMPSON
P100	DOOR	86	6/8	4-17/32"	4-9/16"	9"	7-1/2"	3/4" SHRP	---	---	OVOLO	WOODGRAIN
P100	DOOR	86	7/0	4-17/32"	4-9/16"	9"	7-1/2"	3/4" SHRP	---	---	OVOLO	WOODGRAIN
P1053	DOOR	86	6/8	4-17/32"	4-9/16"	9"	7-1/2"	3/4" SHRP	---	---	OVOLO	WOODGRAIN
P1501	DOOR	90	6/8	4-17/32"	4-9/16"	---	9"	---	---	SAFETY	OVOLO	WOODGRAIN
P1510	DOOR	91	6/8	4-17/32"	4-9/16"	---	9"	---	1-5/16" TDL	SAFETY	OVOLO	WOODGRAIN
P1510	DOOR	91	7/0	4-17/32"	4-9/16"	---	9"	---	1-5/16" TDL	SAFETY	OVOLO	WOODGRAIN
P1512	DOOR	91	8/0	4-17/32"	4-9/16"	---	9"	---	1-5/16" TDL	SAFETY	OVOLO	WOODGRAIN
P1515	DOOR	91	6/8	4-17/32"	4-9/16"	---	9"	---	1-5/16" TDL	SAFETY	OVOLO	WOODGRAIN
P1515	DOOR	91	7/0	4-17/32"	4-9/16"	---	9"	---	1-5/16" TDL	SAFETY	OVOLO	WOODGRAIN
P1518	DOOR	91	8/0	4-17/32"	4-9/16"	---	9"	---	1-5/16" TDL	SAFETY	OVOLO	WOODGRAIN
P1701	SIDELITE	90	6/8	2-1/4"	4-9/16"	---	9-1/2"	---	---	SINGLE	OVOLO	WOODGRAIN
P1701	SIDELITE	90	7/0	2-1/4"	4-9/16"	---	9-1/2"	---	---	SINGLE	OVOLO	WOODGRAIN
P1705	SIDELITE	89	6/8	2-1/4"	4-9/16"	---	9-1/2"	---	1-5/16" TDL	SINGLE	OVOLO	WOODGRAIN
P1705	SIDELITE	89	7/0	2-1/4"	4-9/16"	---	9-1/2"	---	1-5/16" TDL	SINGLE	OVOLO	WOODGRAIN

Stile & Rail Dimensions / Index

STYLE	TYPE	PAGE	HEIGHT	STILE	TOP RAIL	LOCK RAIL	BOTTOM RAIL	PANEL	BAR	GLASS	STICKING	MANUFACTURER
P182	DOOR	87	6/8	4-17/32"	4-9/16"	7-1/2"	9"	1-3/16" DHRP	---	SINGLE	OVOLO	WOODGRAIN
P2035	DOOR	89	6/8	4-17/32"	4-9/16"	7-1/2"	9"	1-3/16" DHRP	1-5/16" TDL	SINGLE	OVOLO	WOODGRAIN
P26146	DOOR	89	6/8	5-17/32"	4-9/16"	7-1/2"	9"	1-3/16" DHRP	1-5/16" TDL	SINGLE	OVOLO	WOODGRAIN
P510	DOOR	89	6/8	4-17/32"	4-9/16"	---	9"	1-3/16" DHRP	1-5/16" TDL	SINGLE	OVOLO	WOODGRAIN
P512	DOOR	89	6/8	4-17/32"	4-9/16"	---	9"	1-3/16" DHRP	1-5/16" TDL	SINGLE	OVOLO	WOODGRAIN
P7002LE	DOOR	90	6/8	2-29/32"	4-7/16"	7-1/2"	9-11/16"	---	---	LOW-E	OVOLO	SIMPSON
P7044	DOOR	85	6/8	5-1/2"	4-7/16"	7-1/2"	9-3/16"	1-7/16" DHRP	---	INSULATED	OVOLO	SIMPSON
P7044	DOOR	85	7/0	5-1/2"	4-7/16"	7-1/2"	9-3/16"	1-7/16" DHRP	---	INSULATED	OVOLO	SIMPSON
P7130	DOOR	84	6/8	5-1/2"	4-7/16"	7-1/2"	9-3/16"	1-7/16" DHRP	---	---	OVOLO	SIMPSON
P7130	DOOR	84	7/0	5-1/2"	4-7/16"	7-1/2"	9-3/16"	1-7/16" DHRP	---	---	OVOLO	SIMPSON
P7132	DOOR	85	6/8	5-1/2"	4-7/16"	7-1/2"	9-3/16"	1-7/16" DHRP	---	INSULATED	OVOLO	SIMPSON
P7282	DOOR	84	6/8	5-1/2"	4-7/16"	7-1/2"	9-3/16"	1-7/16" DHRP	---	---	OVOLO	SIMPSON
P7282	DOOR	84	7/0	5-1/2"	4-7/16"	7-1/2"	9-3/16"	1-7/16" DHRP	---	---	OVOLO	SIMPSON
P7501	DOOR	85	6/8	5-1/2"	4-7/16"	---	9-3/16"	1-7/16" DHRP	---	INSULATED	OVOLO	SIMPSON
P7501	DOOR	85	7/0	5-1/2"	6-7/16"	---	11-3/16"	1-7/16" DHRP	---	INSULATED	OVOLO	SIMPSON
P7701LE	SIDELITE	90	6/8	1-29/32"	4-7/16"	---	9-11/16"	---	---	LOW-E	OVOLO	SIMPSON
P7702	SIDELITE	85	6/8	2-29/32"	4-7/16"	7-1/2"	9-11/16"	1-7/16" DHRP	---	INSULATED	OVOLO	SIMPSON
P7702	SIDELITE	85	7/0	2-29/32"	4-7/16"	7-1/2"	9-11/16"	1-7/16" DHRP	---	INSULATED	OVOLO	SIMPSON
P944	DOOR	87	6/8	4-17/32"	4-9/16"	7-1/2"	9"	1-3/16" DHRP	1-5/16" TDL	SINGLE	OVOLO	WOODGRAIN
P982	DOOR	89	6/8	4-17/32"	4-9/16"	7-1/2"	9"	1-3/16" DHRP	1-5/16" TDL	SINGLE	OVOLO	WOODGRAIN
SM7002	DOOR	81	6/8	5-1/2"	4-7/16"	---	9-3/16"	---	---	INSULATED	OVOLO	SIMPSON
SM7002	DOOR	81	7/0	5-1/2"	6-7/16"	---	11-3/16"	---	---	INSULATED	OVOLO	SIMPSON
SM7130	DOOR	77	6/8	5-1/2"	4-7/16"	7-1/2"	9-3/16"	1-7/16" DHRP	---	---	OVOLO	SIMPSON
SM7130	DOOR	77	7/0	5-1/2"	6-7/16"	7-1/2"	11-3/16"	1-7/16" DHRP	---	---	OVOLO	SIMPSON
SM7282	DOOR	77	6/8	5-1/2"	4-7/16"	7-1/2"	9-3/16"	1-7/16" DHRP	---	---	OVOLO	SIMPSON
SM7282	DOOR	77	7/0	5-1/2"	6-7/16"	7-1/2"	11-3/16"	1-7/16" DHRP	---	---	OVOLO	SIMPSON
SM7282RM	DOOR	77	6/8	5-1/2"	4-7/16"	7-1/2"	9-3/16"	1-7/16" DHRP	---	---	OVOLO	SIMPSON
SM7282RM	DOOR	77	7/0	5-1/2"	6-7/16"	7-1/2"	11-3/16"	1-7/16" DHRP	---	---	OVOLO	SIMPSON
SM7344	DOOR	77	6/8	5-1/2"	4-7/16"	7-1/2"	9-3/16"	1-7/16" DHRP	---	---	OVOLO	SIMPSON

Stile & Rail Dimensions / Index

STYLE	TYPE	PAGE	HEIGHT	STILE	TOP RAIL	LOCK RAIL	BOTTOM RAIL	PANEL	BAR	GLASS	STICKING	MANUFACTURER
SM7344	DOOR	77	7/0	5-1/2"	6-7/16"	7-1/2"	11-3/16"	1-7/16" DHRP	---	---	OVOLO	SIMPSON
SM7501LE	DOOR	77	6/8	5-1/2"	4-7/16"	7-1/2"	9-3/16"	1-7/16" DHRP	---	LOW-E	OVOLO	SIMPSON
SM7501LE	DOOR	77	8/0	5-1/2"	4-7/16"	7-1/2"	9-3/16"	1-7/16" DHRP	---	LOW-E	OVOLO	SIMPSON
SM77015	DOOR	82	6/8	5-1/2"	5-7/16"	---	9-3/16"	---	7/8" SDL	LOW-E	OVOLO	SIMPSON
SM7702	SIDELITE	77	6/8	2-29/32"	4-7/16"	---	9-11/16"	1-7/16" DHRP	---	INSULATED	OVOLO	SIMPSON
SM7702	SIDELITE	77	7/0	2-29/32"	6-7/16"	---	11-11/16"	1-7/16" DHRP	---	INSULATED	OVOLO	SIMPSON
SM7702RM	SIDELITE	77	6/8	2-29/32"	4-7/16"	---	9-11/16"	1-7/16" DHRP	---	INSULATED	OVOLO	SIMPSON
SM7702RM	SIDELITE	77	7/0	2-29/32"	6-7/16"	---	11-11/16"	1-7/16" DHRP	---	INSULATED	OVOLO	SIMPSON
SM37703	SIDELITE	80	6/8	2-29/32"	4-7/16"	---	9-11/16"	1-7/16" DHRP	7/8" SDL	INSULATED	OVOLO	SIMPSON
SM37703	SIDELITE	80	7/0	2-29/32"	6-7/16"	---	11-11/16"	1-7/16" DHRP	7/8" SDL	INSULATED	OVOLO	SIMPSON
SM37705	SIDELITE	81	6/8	2-29/32"	4-7/16"	---	9-11/16"	---	7/8" SDL	INSULATED	OVOLO	SIMPSON
SM37705	SIDELITE	81	7/0	2-29/32"	6-7/16"	---	11-11/16"	---	7/8" SDL	INSULATED	OVOLO	SIMPSON
SM77130	DOOR	75	6/8	5-1/2"	5-7/16"	7-1/2"	9-3/16"	1-7/16" DHRP	---	---	OVOLO	SIMPSON
SM77144	DOOR	75	6/8	5-1/2"	5-7/16"	7-1/2"	9-3/16"	1-7/16" DHRP	---	---	OVOLO	SIMPSON
SM77465	DOOR	75	6/8	5-1/2"	5-7/16"	7-1/2"	9-3/16"	1-7/16" DHRP	---	---	OVOLO	SIMPSON
SM77506	DOOR	79	6/8	5-1/2"	5-7/16"	7-1/2"	9-3/16"	1-7/16" DHRP	7/8" SDL	LOW-E	OVOLO	SIMPSON
SM77662	DOOR	79	6/8	5-1/2"	5-7/16"	---	9-3/16"	1-7/16" DHRP	7/8" SDL	LOW-E	OVOLO	SIMPSON
SM77663	SIDELITE	79	6/8	2-29/32"	5-7/16"	---	9-11/16"	1-7/16" DHRP	7/8" SDL	LOW-E	OVOLO	SIMPSON
SM77701	SIDELITE	75	6/8	2-29/32"	5-7/16"	---	9-11/16"	---	---	LOW-E	OVOLO	SIMPSON
SM77703	SIDELITE	79	6/8	2-29/32"	5-7/16"	---	9-11/16"	1-7/16" DHRP	7/8" SDL	LOW-E	OVOLO	SIMPSON
SM77705	SIDELITE	82	6/8	2-29/32"	5-7/16"	---	9-11/16"	---	7/8" SDL	LOW-E	OVOLO	SIMPSON
SM77803	SIDELITE	79	6/8	2-29/32"	5-7/16"	---	9-11/16"	1-7/16" DHRP	7/8" SDL	LOW-E	OVOLO	SIMPSON
SM77944	DOOR	79	6/8	5-1/2"	5-7/16"	7-1/2"	9-3/16"	1-7/16" DHRP	7/8" SDL	LOW-E	OVOLO	SIMPSON
SM7801LE	SIDELITE	77	6/8	2-29/32"	4-7/16"	---	9-7/8"	1-7/16" DHRP	---	LOW-E	OVOLO	SIMPSON
SM7801LE	SIDELITE	77	8/0	2-29/32"	4-7/16"	---	9-7/8"	1-7/16" DHRP	---	LOW-E	OVOLO	SIMPSON
SM37944	DOOR	80	6/8	5-1/2"	4-7/16"	7-1/2"	9-3/16"	1-7/16" DHRP	7/8" SDL	INSULATED	OVOLO	SIMPSON
SM37944	DOOR	80	7/0	5-1/2"	6-7/16"	7-1/2"	11-3/16"	1-7/16" DHRP	7/8" SDL	INSULATED	OVOLO	SIMPSON

Unit Dimensions & Rough Openings

INSWING UNITS

Height

For a 6'8" unit, the height of the unit is dependent on the sill used.

Adjustable Composite Sill (Standard): Unit Size Height - 82", Rough Opening Height - 82-1/2"

Public Access Sill: Unit Size Height - 81", Rough Opening Height - 81-1/2"

7/4 Inswing Wood Sill: Unit Size Height - 82", Rough Opening Height - 82-1/2"

Note: All doors are 6'8" in height. To find the unit size or rough opening for other heights, please add or subtract the following:

6'6" doors: deduct 2" from the height

7'0" doors: add 4" to the height.

8'0" doors: add 16" to the height.

Width

The width of the unit is dependent on the configuration. Choose the configuration type of your unit and then the door size to find your unit size and rough opening widths.

Single Unit			Continuous Single with One Sidelite Standard Mull Post			Continuous Single with Two Sidelites Standard Mull Post		
Description	Unit Size Width	Rough Opening Width	Description	Unit Size Width	Rough Opening Width	Description	Unit Size Width	Rough Opening Width
10" sidelite	11-1/2"	12-1/4"	3'0" w/ 10" s/l	48-5/8"	49-3/8"	3'0" w/ 10" s/l	59-5/8"	60-3/8"
12" sidelite	13-1/2"	14-1/4"	3'0" w/ 12" s/l	50-5/8"	51-3/8"	3'0" w/ 12" s/l	63-5/8"	64-3/8"
14" sidelite	15-1/2"	16-1/4"	3'0" w/ 14" s/l	52-5/8"	53-3/8"	3'0" w/ 14" s/l	67-5/8"	68-3/8"
2'0"	25-5/8"	26-3/8"						
2'4"	29-5/8"	30-3/8"						
2'6"	31-5/8"	32-3/8"						
2'8"	33-5/8"	34-3/8"						
2'10"	35-5/8"	36-3/8"						
3'0"	37-5/8"	38-3/8"						
3'6"	43-5/8"	44-3/8"						

Double Door 7/8" Astragal			Patio Door Standard Mull Post			Triple Patio Door Standard Mull Post		
Description	Unit Size Width	Rough Opening Width	Description	Unit Size Width	Rough Opening Width	Description	Unit Size Width	Rough Opening Width
4'8"	58-9/16"	59-5/16"	4'8"	58-13/16"	59-9/16"	7'0"	88"	88-3/4"
5'0"	62-9/16"	63-5/16"	5'0"	62-13/16"	63-9/16"	7'6"	94"	94-3/4"
5'4"	66-9/16"	67-5/16"	5'4"	66-13/16"	67-9/16"	8'0"	100"	100-3/4"
5'8"	70-9/16"	71-5/16"	5'8"	70-13/16"	71-9/16"	8'6"	106"	106-3/4"
6'0"	74-9/16"	75-5/16"	6'0"	74-13/16"	75-9/16"	9'0"	112"	112-3/4"

Continuous Single with One Venting Sidelite Wide Mull Post			Continuous Single with Two Venting Sidelites Wide Mull Post			Continuous Double with Two Venting Sidelites 7/8" Astragal, Wide Mull Post		
Description	Unit Size Width	Rough Opening Width	Description	Unit Size Width	Rough Opening Width	Description	Unit Size Width	Rough Opening Width
2'6" w/1 12" s/l	45-3/8"	46-1/8"	3'0" w/2 12" s/l	65-1/16"	65-13/16"	5'0" w/2 12" s/l	90"	90-3/4"
2'6" w/1 14" s/l	47-3/8"	48-1/8"	3'0" w/2 14" s/l	69-1/16"	69-13/16"	5'0" w/2 14" s/l	94"	94-3/4"
2'8" w/1 12" s/l	47-3/8"	48-1/8"	Other sizes are available special order, contact Reeb for details			5'4" w/2 12" s/l	94"	94-3/4"
2'8" w/1 14" s/l	49-3/8"	50-1/8"				5'4" w/2 14" s/l	98"	98-3/4"
2'10" w/1 12" s/l	49-3/8"	50-1/8"	Note: 8/0 venting sidelites are only available in 14" width.			5'8" w/2 12" s/l	98"	98-3/4"
2'10" w/1 14" s/l	51-3/8"	52-1/8"				5'8" w/2 14" s/l	102"	102-3/4"
3'0" w/1 12" s/l	51-3/8"	52-1/8"				6'0" w/2 12" s/l	102"	102-3/4"
3'0" w/1 14" s/l	53-3/8"	54-1/8"				6'0" w/2 14" s/l	106"	106-3/4"

Dimension Adders

Rough Opening (the opening in a standard wall): add 3/4" to the Unit Width and 1/2" to the Unit Height

Brickmould Dimension (from edge of brickmould to edge of brickmould): add 2-1/2" to the Unit Width and 1-1/4" to the Unit Height

Masonry Opening (the opening in a masonry wall): add 3" to the Unit Width and 1-1/2" to the Unit Height

Boxed Unit Rough Opening (individual units mulled together): Add each unit dimensions then add 3/4" to the Width and 1/2" to the Height

Transoms (glass component on top of the unit): Add door unit dimension and transom unit dimension, then add Rough Opening Adder

Unit Dimensions & Rough Openings

OUTSWING UNITS

Height

For a 6'8" unit, the height of the unit is dependent on the sill used.

Adjustable Composite Sill (Standard): Unit Size Height - 81-3/16", Rough Opening Height - 81-11/16"

Public Access Sill: Unit Size Height - 81", Rough Opening Height - 81-1/2"

Outswing Bumper Sill: Unit Size Height - 80-5/8", Rough Opening Height - 81-1/8"

7/4 Outswing Wood Sill: Unit Size Height - 82", Rough Opening Height - 82-1/2"

Note: All doors are 6'8" in height. To find the unit size or rough opening for other heights, please add or subtract the following:

6'6" doors: deduct 2" from the height

7'0" doors: add 4" to the height.

8'0" doors: add 16" to the height.

Width

The width of the unit is dependent on the configuration. Choose the configuration type of your unit and then the door size to find your unit size and rough opening widths.

Single Unit		
Description	Unit Size Width	Rough Opening Width
10" sidelite	11-1/2"	12-1/4"
12" sidelite	13-1/2"	14-1/4"
14" sidelite	15-1/2"	16-1/4"
2'0"	25-5/8"	26-3/8"
2'4"	29-5/8"	30-3/8"
2'6"	31-5/8"	32-3/8"
2'8"	33-5/8"	34-3/8"
2'10"	35-5/8"	36-3/8"
3'0"	37-5/8"	38-3/8"
3'6"	43-5/8"	44-3/8"

Double Door 7/8" Astragal		
Description	Unit Size Width	Rough Opening Width
4'8"	58-9/16"	59-5/16"
5'0"	62-9/16"	63-5/16"
5'4"	66-9/16"	67-5/16"
5'8"	70-9/16"	71-5/16"
6'0"	74-9/16"	75-5/16"

Continuous Single Unit with One Sidelite Standard Mull Post		
Description	Unit Size Width	Rough Opening Width
3'0" w/ 10" s/l	48-5/8"	49-3/8"
3'0" w/ 12" s/l	50-5/8"	51-3/8"
3'0" w/ 14" s/l	52-5/8"	53-3/8"

Continuous Single Unit with Two Sidelites Standard Mull Post		
Description	Unit Size Width	Rough Opening Width
3'0" w/ 10" s/l	59-5/8"	60-3/8"
3'0" w/ 12" s/l	63-5/8"	64-3/8"
3'0" w/ 14" s/l	67-5/8"	68-3/8"

Patio Door Standard Mull Post		
Description	Unit Size Width	Rough Opening Width
4'8"	58-13/16"	59-9/16"
5'0"	62-13/16"	63-9/16"
5'4"	66-13/16"	67-9/16"
5'8"	70-13/16"	71-9/16"
6'0"	74-13/16"	75-9/16"

Triple Patio Door Standard Mull Post		
Description	Unit Size Width	Rough Opening Width
7'0"	88"	88-3/4"
7'6"	94"	94-3/4"
8'0"	100"	100-3/4"
8'6"	106"	106-3/4"
9'0"	112"	112-3/4"

Dimension Adders

Rough Opening (the opening in a standard wall): add 3/4" to the Unit Width and 1/2" to the Unit Height

Brickmould Dimension (from edge of brickmould to edge of brickmould): add 3" to the Unit Width and 1-1/2" to the Unit Height

Masonry Opening (the opening in a masonry wall): add 3-1/2" to the Unit Width and 1-3/4" to the Unit Height

Boxed Unit Rough Opening (individual units mull together): Add each unit dimensions then add 3/4" to the Width and 1/2" to the Height

Transoms (glass component on top of the unit): Add door unit dimension and transom unit dimension, then add Rough Opening Adder



Visitors to **learn.reeb.com** have free unrestricted access to engaging, high-quality lessons taught by recognized industry experts.

For 20 years, Reeb has educated dealers, architects and industry professionals on everything door related, from how to choose the proper door unit and correctly install a door, to what options are available and new product information.

In an industry filled with many complex choices and regulations, Reeb is committed to offering training to dealers and their staff to empower them to better serve their customers each and every day.

Target Audience

Dealers require a lot of information, and a good dealer is only going to pick the best door products to sell based off the information they are given. In addition to the technical information (how the doors are made, material selections, options available, maintenance, efficiency/DP ratings), the dealer is also responsible for educating his or her employees and customers, the majority who may not be familiar with the technical terms or industry jargon, and thus need simplified facts.

Engaged Homeowners care about their family's safety, and their investment. The products they purchase need to be durable, provide security, and yet blend with the visual aesthetic of the home, all for a reasonable investment. The engaged homeowner will be more interested in the technical side and specs of the product than the general customer since they are the ones responsible for how the product will perform under real-world scenarios.

Having one spot to search and find information is important – that's why certain search engine sites have become so popular.

We are working to add more articles that give you the answers you need about a product or product line. You can simply use the search bar or dive into the topics to find the answer to your questions.

Some people are visual learners so we created videos to better share the stories. Some discuss our product offerings and compare similar products, while others share information about a specific topic.

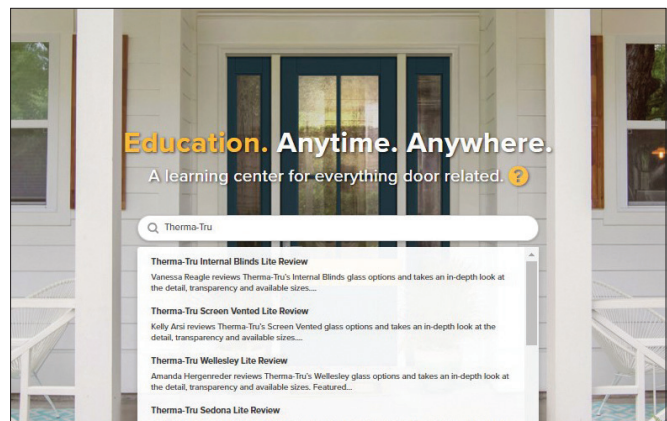

The Reeb® Learning Center has expanded with the addition of Learning Paths.

It can be tough to know where to start learning. A learning path is a collection of courses that a learner can progress through. Each course contains step-by-step lessons to teach you about doors from start to finish.

- Guided learning to boost your door knowledge
- Knowledge Checks help gauge understanding
- A Final Quiz tests the overall knowledge gathered
- Earn certifications for every course
- Earn rewards when completing a learning path
- System tracks all progress
- Need to stop and come back later? No Problem!
- Education anytime and anywhere
- Great resource for employees new to the millwork industry

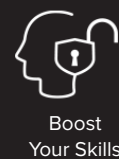
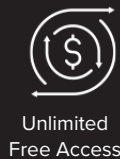
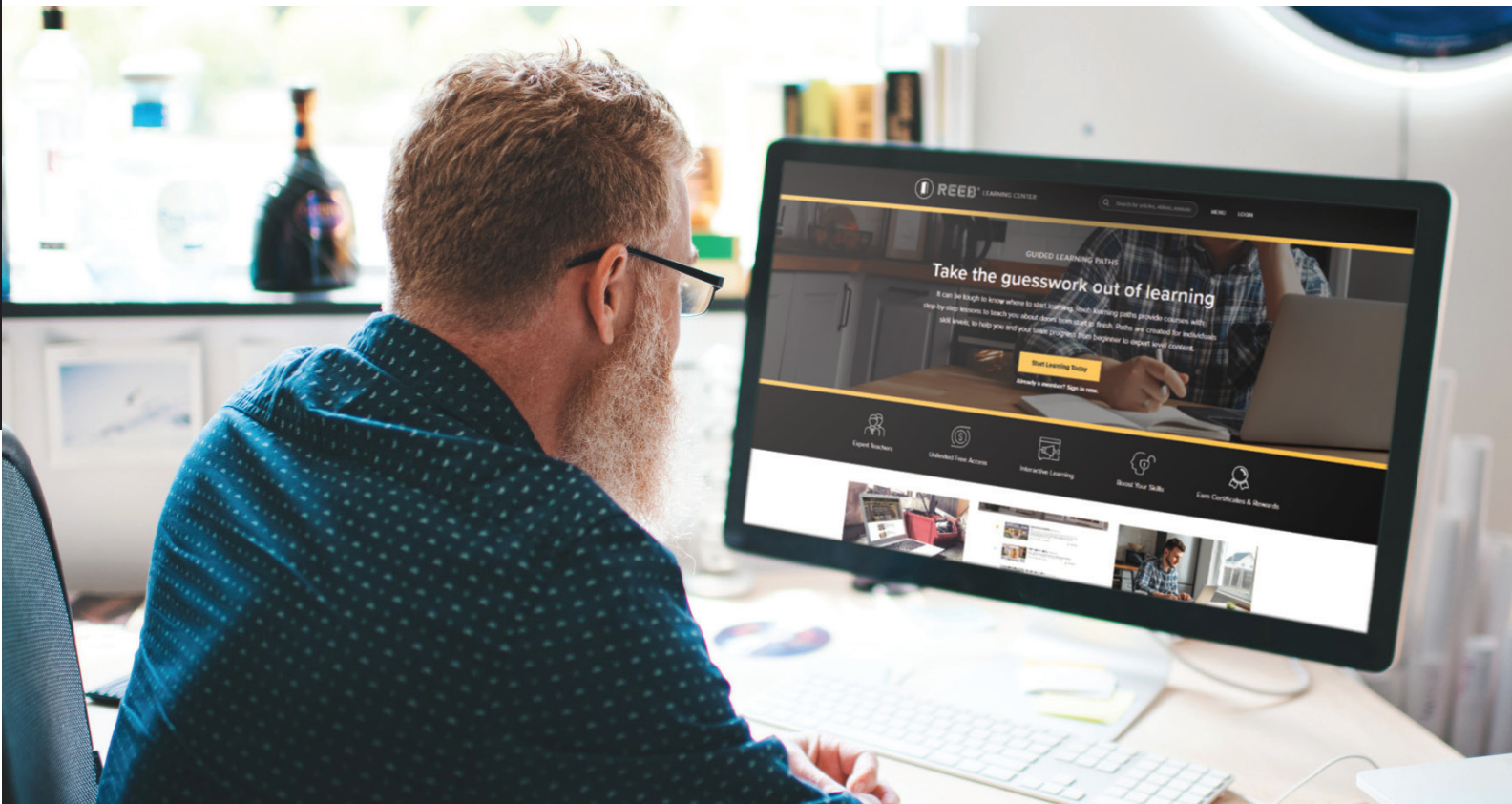

Subscribe Today!

By subscribing to the Learning Center, you will receive a monthly email informing you of the newest videos and articles that are available as well as a reminder of some of the recently released items. Whether you need a recap or want to learn more about something new, subscribing is the best way to stay informed. Head to learn.reeb.com and enter your email at the bottom of the page to subscribe!

Care & Finishing

Your Reeb door has been handcrafted to last for years to come. And like any piece of fine furniture, it needs proper finishing and periodic maintenance to keep it performing its best. For a long-lasting, beautiful wood door, please follow the instructions as outlined in the appropriate section below. Failure to follow Reeb's care & finishing recommendations will void the door's warranty.

FINISHING OPTIONS

Because Reeb doors are crafted with only the finest materials, you can choose from a wide variety of stain or paint possibilities. Paint dealers have a broad selection of color chips on hand to demonstrate the look you can achieve when staining fine wood such as douglas fir, western hemlock or red oak used in wood doors.

If you choose paint instead of stain, you can apply either oil-base or acrylic resin-base paints over an oil-base primer. However, take care in following the finishing instructions provided here. Also, be sure to evaluate the conditions your door must endure, such as direct exposure to severe climates, before deciding on the specific finish to use. All Reeb wood doors must be finished within 72 hours after installation to meet manufacturer's warranty.

CAUTION: If during the finish process you are having issues and/or identify problems with your door, stop finishing immediately and contact the company from where you purchased your doors.

PREPARATION FOR FINISHING

1. Before applying the first coat of finish, remove all handling marks, raised grain and other undesirable blemishes by sanding all surfaces with 180 grit sandpaper (this applies to both raw wood and primed doors). For doors with shaker sticking, lightly ease the outside edge of the sticking with sandpaper. To avoid cross-grain scratches, sand with the grain. **NOTE:** small amounts of grease, oil or pitch can be wiped clean with denatured alcohol or turpentine.
2. Adjust or align components if necessary before finishing. Wood panels "float" and may be knocked into alignment with a wood block and hammer. Be careful not to damage door.
3. After sanding, clean door thoroughly with a cloth to remove all dust or foreign material. Do not use caustic or abrasive cleaners.
4. Hang door before finishing, and then remove to finish properly. Doors must be properly sealed prior to installation of hardware and exposure to moisture or weather. Properly finish door immediately before prolonged storage.

5. All surfaces of the door must be properly finished. The edges (top, bottom and sides) should be coated with each and every coat of finish that is applied to the exterior surface of the door. Doors must be dry before finishing.
6. On doors that are glazed with clear glass, the finish used should be flowed from the wood slightly onto the glass. This will provide assurance against water leakage and protect the glazing compound "putty" from drying out. Excess putty can be removed, just make sure to not use anything sharp like a razor blade, as glass can be scratched.
7. **NOTE:** It is the finisher's responsibility to protect glass prior to and during finishing. If using tape, conduct a test of the tape being used on a small area of the glass before applying to a large surface. After finishing, remove the tape as soon as possible.
8. On doors that have plastic film protection on glass, removal of plastic film protection immediately after applying the finish is required. Failure to remove the plastic film at this time may cause harm to the glass and will create difficulty in removing the film at a later time. Do not use razor blades or sharp objects to remove the film or clean the glass. These items will scratch the glass.

EXTERIOR FINISHING

STAIN-AND-CLEAR FINISH

The recommended process for finishing Reeb wood doors is a 3-step process. Step 1: application of a wood conditioner. Step 2: application of a stain. Step 3: application of at least three top coats of a clear finish. When selecting the finishes for these three steps, select products that have been designed to work together.

A wood conditioner prepares the wood to accept finish uniformly and helps to spread the finish evenly. When selecting a wood conditioner, the type of conditioner needs to match the stain. For example a water-based conditioner for a water-based stain or an oil-based conditioner for an oil-based stain.

Stains are available in a wide range of colors. Whatever color you select should have an alkyd-resin base. Under no circumstances should a lacquer-based finish system be used on exterior doors.

The three (minimum) top coats may be a solvent-borne (oil-base, alkyd resin-base, polyurethane resin-base) or a water-borne (acrylic resin-base) clear finish. See notes (1) and (2) below.

The advantages and disadvantages of solvent-borne vs. water-borne clear finishes are as follows:

1. Solvent-Borne Advantages: Cures faster, harder and more water resistant. May be applied under variable weather conditions. Disadvantages: Subject to ultraviolet degradation and not as flexible or durable as water-borne clear finish.
2. Water-Borne Advantages: Very flexible, greater ultraviolet resistance, and good exterior durability. Disadvantages: Cannot be applied below 50° F, long curing period required, and may not fully cure for several weeks. Water-sensitive until cure is complete.

NOTE: Do not sand between coats of clear acrylic. All stain-and-clear finishes will perform measurably better if protected from the direct effects of sunlight and weathering, and refinishing will not be required as frequently.

PAINT FINISH

Either oil-base or acrylic resin-base exterior grade paints may be used with success on panel doors. Oil-base paints offer more resistance to the passage of water (liquid and vapor) than acrylic resin-base paints, but the latter have better durability and color retention.

Doors should be sealed with a good quality oil-base primer followed by two top coats of either an oil-base or acrylic resin-base paint. Of course, both primer and top coat should be made by the same manufacturer and designed to be used as a combination.

If the door has been provided factory-primed, there is some basic prep work that needs to be done before painting. All primed surfaces should be scuff sanded to encourage better paint adhesion. Any rough areas of primer or machined wood should also be sanded. For doors provided with WaterBarrier® technology, neither the exterior stile and rail surfaces nor the exterior divided lite bars (made from PVC) are to be sanded.

NOTE: Where possible exposure to direct sun or rain is a factor, to keep your wood doors beautiful they require periodic resealing or painting dependent on weather or moisture exposure. Do not use dark colored stains or paint on doors exposed to sunlight, as some expansion and contraction of door parts may occur. Further, a dark colored stain or paint can void the door's warranty.

CAUTION: Reeb cannot evaluate all the available paints and stains, nor the customers' specific application requirements. Your paint dealer should know of suitable finish systems that give satisfactory results in your region. It is highly recommended that top quality finishes be selected, and the application instructions on the container be followed explicitly.

Sikkens Cetol Door & Window finish products are not to be used in finishing Simpson doors. This product has resulted in poor performance in the field. Use of Sikkens Cetol Door & Window products will void Simpson's warranty.

HIGH EXPOSURE FINISHING

1. Use an oil-based primer followed by at least three top coats of a high quality oil or acrylic-based paint on the exterior. Acrylic is more durable and has better color retention.
2. Use a silicone or caulking bead (must be compatible with paint) around the perimeter of each glass pane. This will seal the putty and prevent any moisture from running directly into the door.
3. Ensure all finish coats are allowed to flow into the glass area at least 1/16".
4. Ensure all coatings that go on the surface of the door are also applied to the top and bottom. Coat all six sides of every door, or your warranty will be voided.
5. Silicone the door bottom sweep onto the bottom of the door and apply a surface mount drip cap to the bottom of each door to allow for moisture runoff onto the sill.
6. For outswing units: Prior to finishing the top of the inactive door, be sure to fill the mortise pocket around the flush bolt prep with silicone or caulking. Moisture has a history of pooling up in this area on outswing units. Consider a thin layer of metal across the top of the door to keep moisture from direct contact with the wood.
7. Storm or screen doors may be mandatory to completely eliminate moisture problems. Storm doors must be vented to eliminate temperature build-up.
8. Performance Series® upgrades are recommended for high exposure door openings. Request WaterBarrier® and UltraBlock® technologies from your Simpson retailer to get the most life out of your door. And if you are selecting a french door, we strongly recommend specifying Simpson's WaterBarrier technology.

PAINT FINISH SPECIFICS

1. "Bridge" finish from face of door to moulding, ensuring there is no gap between moulding and surface of the door.
2. "Bridge" finish as noted above on inside of panel area where moulding meets panel and/or glass.
3. Ensure all moulding miters are well-coated, leaving no gaps.

Other Products

While wood doors are natural and beautiful, they do require a certain amount of care and maintenance. If you are looking for an exterior door option that is a lower maintenance option, or love your wood front door, but need additional exterior doors to complement it, consider Therma-Tru Fiberglass Exterior Doors.

Fiberglass is a great option for your main entry, as well as the other exterior doors in your home, like back doors, patio doors, or home to garage access.



Consider a Therma-Tru Fiberglass door finished in a Reeb Finish Prismaguard Stain. It brings the authentic look of wood to life with rich tones that add dimension and are designed to enhance the wood grains.

Reeb has what you need for all of your home's doors.



REEB[®]
LEARNING CENTER

A learning center for everything door related.

Visit the Reeb[®] Learning Center for education on choosing the proper door unit, new products, and what product options are available. Visit the Reeb Learning Center at learn.reeb.com.

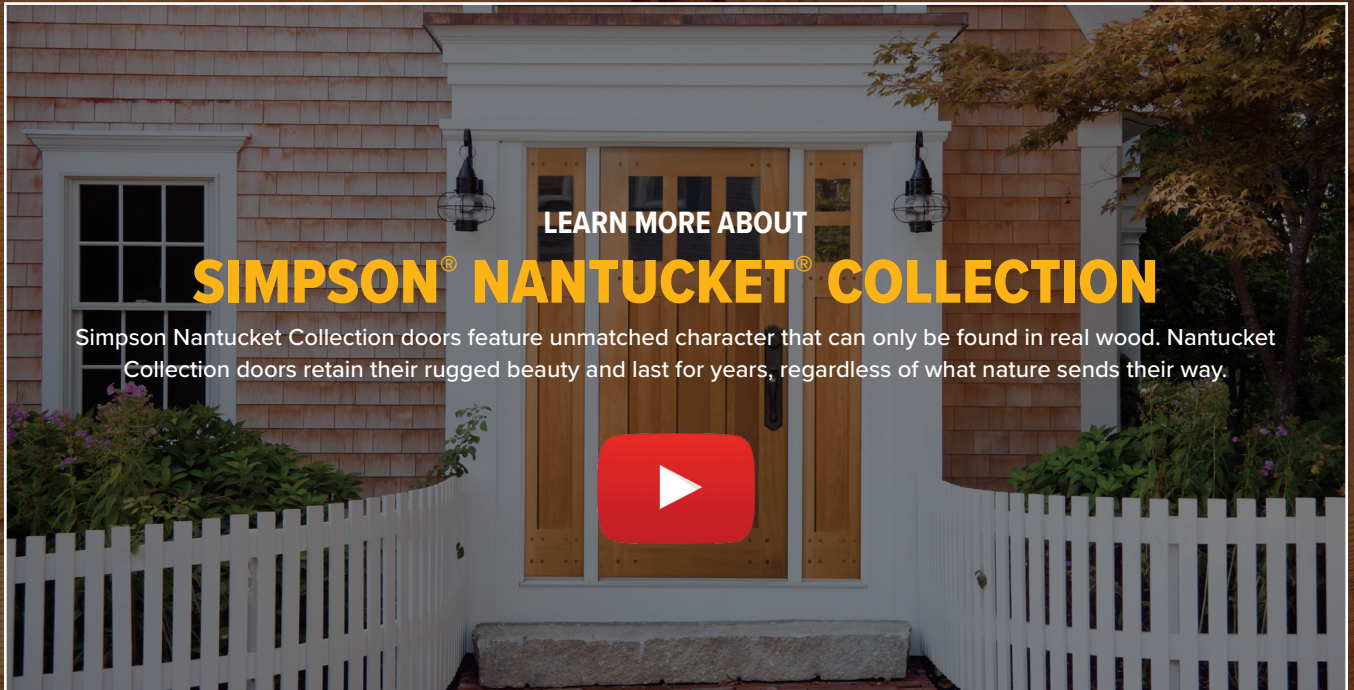

Online Exterior Stile & Rail Catalog

For an interactive format of this catalog, please visit reeb.com/catalogs



Reeb[®] Warranty Information

View product warranties at reeb.com/warranties

□ Bethlehem, PA
1000 Maloney Cir.
Bethlehem, PA 18015
(800) 862-8622 voice
(800) 772-7332 fax

□ Barclay, MD
1315 Goldsboro Rd.
Barclay, MD 21607
(800) 825-8331 voice
(800) 331-9387 fax

□ Mocksville, NC
346 Bethel Church Rd.
Mocksville, NC 27028
(800) 642-0886 voice
(800) 618-0620 fax

□ Providence, RI
19 Business Park Dr.
Smithfield, RI 02917
(800) 343-5703 voice
(800) 388-5979 fax

□ Syracuse, NY
7475 Henry Clay Blvd.
Liverpool, NY 13088
(800) 422-5224 voice
(800) 531-7332 fax



PART# REEBEXT21
VERSION 1.1.0